

ORNO
FOR HOME

ORNO
FOR PROFESSIONALS

Adviti
LIGHTING SOLUTIONS

ViRONE
simple made easy.

Nowości produktowe
New products

2023-2024

Spis treści

Table of contents

5

Automatyka budynkowa

Home automation

Dzwonki przewodowe	6
Wired doorbells	
Dzwonki bezprzewodowe	8
Wireless doorbells	
Domofony	12
Audio doorphones	
Wideodomofony	13
Video doorphones	

25

Oświetlenie

Lighting

Plafony bez czujnika ruchu z wymiennym źródłem światła	26
Ceiling lights without motion sensor with replaceable light source	
Plafony bez czujnika ruchu ze zintegrowanym źródłem światła LED	28
Ceiling lights without motion sensor with integrated LED light source	
Plafony z czujnikiem ruchu i wymiennym źródłem światła	30
Ceiling lights without motion sensor with replaceable light source	
Plafony z czujnikiem ruchu i zintegrowanym źródłem światła LED	32
Ceiling lights with motion sensor and integrated LED light source	
Źródła światła	34
Light sources	
Oprawy liniowe	35
Linear lights	
Lampy ściennie-sufitowe	36
Wall and ceiling lights	
Lampy wiszące	50
Pendant lights	
Lampy stojące	64
Floor lamps	
Lampki nocne	66
Night lamps	
Lampki biurkowe	67
Desk lamps	

Klamki i nakładki szyfrowe	17
Smart handles and door locks	
Atrapy kamer	20
Dummy cameras	
Kamery	21
Cameras	
Czujniki tlenku węgla	22
Carbon monoxide sensors	
Włęczniki	23
Switches	

Oprawy meblowe	68
Furniture luminaires	
Oświetlenie szynowe	70
Track lighting	
Oświetlenie przemysłowe	72
Industrial lighting	
Naświetlacze	74
Floodlights	
Oprawy ogrodowe	77
Garden luminaires	
Oświetlenie robocze	78
Workshop lights	
Latarki	80
Flashlights	
Taśmy LED	82
LED Strips	
Elementy taśm LED	86
LED strip components	
Profile aluminiowe do taśm LED	90
Aluminium profiles for LED strips	
Klosze do profili aluminiowych	92
Aluminium profiles covers	
Akcesoria do profili	93
Profiles accessories	
Adaptory	94
Light source adapters	

97

Elektryka

Electricity

Aparatura modułowa	98
Modular apparatus	
Watomierze i programatory	108
Power meters and programmers	
Osprzęt domowy	111
Household electrical accessories	
Osprzęt warsztatowy	128
Workshop plugs and sockets	
Przedłużacze domowe	130
Home extension sockets	
Listwy zasilające	134
Power strips	
Gniazda meblowe wpuszczane	138
Flush-mounted furniture sockets	
Gniazda meblowe nablátowe	146
Surface-mounted furniture sockets	
Gniazda meblowe podszaífkowe	147
Under-cabinet furniture socket	
Technika łączeniowa	150
Connection technique	
Akcesoria elektroinstalacyjne	155
Electrical installation accessories	

159

Produkty konsumenckie

Consumer goods

Adaptéry podróźne	160
Travel adapters	
Skrzýnki pocztowe	162
Mailboxes	
Uchwyty TV	164
TV mounts	
Złączki antenowe	166
Antennae connectors	



Automatyka budynkowa

Home automation

Nowości produktowe
New products

2023/2024

Dzwonki przewodowe

Wired doorbells



Quarto AC

Dzwonek przewodowy dwutonowy
Two-tones wired doorbell



Napięcie nominalne: 230V~, 50Hz
Nominal voltage: 230V~, 50Hz



Dzwonek elektromechaniczny
Electromechanical doorbell



Głośność: 80dB
Loudness: 80 dB



2 Dźwięki: Ding Dong
2 Ding Dong sounds



OR-DP-MR-149/W



OR-DP-MR-149/B



OR-DP-MR-149/PW



OR-DP-MR-149/GR

Symbol Product no.	EAN	Napięcie nominalne Nominal voltage	Typ Type	Stopień ochrony Protection level	Kolor Color	Wymiary (szer./wys./gt. [mm]) Dimensions (W/H/D [mm])
OR-DP-MR-149/W	5908254800658	230V~, 50Hz	Elektromechaniczny Electromechanical	IP20	Biały White	110 / 110 / 39
OR-DP-MR-149/B	5908254820229	230V~, 50Hz	Elektromechaniczny Electromechanical	IP20	Czarny Black	110 / 110 / 39
OR-DP-MR-149/PW	5908254803635	230V~, 50Hz	Elektromechaniczny Electromechanical	IP20	Śnieżno biały Pure white	110 / 110 / 39
OR-DP-MR-149/GR	5908254825149	230V~, 50Hz	Elektromechaniczny Electromechanical	IP20	Szary Grey	110 / 110 / 39



Brevis Maxi AC

Dzwonek przewodowy dwutonowy
Two-tones wired doorbell



Napięcie nominalne: 230V~, 50Hz
Nominal voltage: 230V~, 50Hz



Dzwonek elektromechaniczny
Electromechanical doorbell



Głośność: 80dB
Loudness: 80 dB



2 Dźwięki: Ding Dong
2 Ding Dong sounds



OR-DP-MR-150/W



OR-DP-MR-150/B



OR-DP-MR-150/PW

Symbol Product no.	EAN	Napięcie nominalne Nominal voltage	Typ Type	Stopień ochrony Protection level	Kolor Color	Wymiary (szer./wys./gł. [mm]) Dimensions (W/H/D [mm])
OR-DP-MR-150/W	5908254800641	230V~, 50Hz	Elektromechaniczny Electromechanical	IP20	Biały white	105/ 162 / 36
OR-DP-MR-150/B	5908254822483	230V~, 50Hz	Elektromechaniczny Electromechanical	IP20	Czarny Black	105/ 162 / 36
OR-DP-MR-150/PW	5908254803642	230V~, 50Hz	Elektromechaniczny Electromechanical	IP20	Śnieżno biały Pure white	105/ 162 / 36

Dzwonki bezprzewodowe

Wireless doorbells

ViRONE
simple made easy.

Falante

Dzwonek bezprzewodowy bateryjny
Wireless, battery-powered doorbell



Odbiornik: 3 x AA
Receiver: 3 x AA



Nadajnik: 1 x CR2032
Transmitter: 1 x CR2032



Funkcja learning system
Learning system technology



Zasięg: 200m
Range: 200m



Liczba dźwięków: 38
Number of sounds: 38



Regulacja głośności: 60-85dB
Volume control: 60-85dB

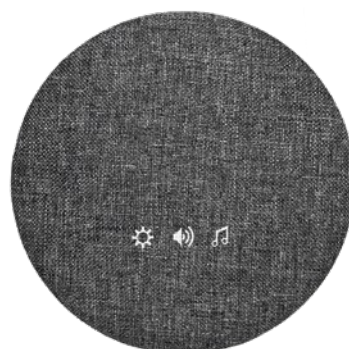

Symbol
Product no.

EAN

Zasilanie odbiornika
Power supply of receiver

Zasilanie nadajnika
Power supply of transmitter

Zasięg
Range

Stopień ochrony
Protection level

Wymiary (szer./wys./gł. [mm])
Dimensions (W/H/D [mm])

DB-5

5908254828669

3 x AA

1x CR2032

200m

IP44

Odbiornik / Receiver: 124,8 / 124,8 / 36,6
Nadajnik / Transmitter: 32 / 76 / 17



Tela AC

Dzwonek bezprzewodowy sieciowy
Wireless, mains-powered doorbell



Odbiornik: 230V~, 50Hz

Receiver: 230V~, 50Hz

NAME



Tela DC

Dzwonek bezprzewodowy bateryjny
Wireless, battery-powered doorbell



Odbiornik: 2 x AA

Receiver: 2 x AA

NAME



Nadajnik: 1 x CR2032

Transmitter: 1 x CR2032



Funkcja learning system

Learning system technology



Zasięg: 150m

Range: 150m



Liczba dźwięków: 38

Number of sounds: 38



Regulacja głośności: 60-85dB

Volume control: 60-85dB

Symbol Product no.	EAN	Zasilanie odbiornika Power supply of receiver	Zasilanie nadajnika Power supply of transmitter	Zasięg Range	Stopień ochrony Protection level	Wymiary (szer./wys./gł. [mm]) Dimensions (W/H/D [mm])
OR-DB-KA-167/W	5908254842573	230V~, 50Hz	1x CR2032	150m	IP44	Odbiornik / Receiver: 71 / 71 / 67,5 Nadajnik / Transmitter: 73 / 30 / 15
OR-DB-KA-168/W	5908254842603	2 x AA	1x CR2032	150m	IP44	Odbiornik / Receiver: 71 / 71 / 31,5 Nadajnik / Transmitter: 73 / 30 / 15

Ondo AC



Dzwonek bezprzewodowy bezbaterijny
Battery-free wireless doorbell



Odbiornik: 230V~, 50Hz
Receiver: 230V~, 50Hz



Bezbaterijny przycisk
Battery-free transmitter



Funkcja learning system
Learning system technology



Zasięg: 200m
Range: 200m



Liczba dźwięków: 36
Number of sounds: 36



Regulacja głośności: 60-90dB
Volume control: 60-90dB



OR-DB-MT-156

OR-DB-MT-156/W

Symbol Product no.	EAN	Zasilanie odbiornika Power supply of receiver	Zasilanie nadajnika Power supply of transmitter	Stopień ochrony Protection level	Kolor Color	Wymiary (szer./wys./gt. [mm]) Dimensions (W/H/D [mm])
OR-DB-MT-156	5908254805721	230V~, 50Hz	Bezbaterijne Battery-free	IP44	Czarny Black	Odbiornik / Receiver: 81 / 81 / 72 Nadajnik / Transmitter: 82 / 50 / 21,5
OR-DB-MT-156/W	5908254826504	230V~, 50Hz	Bezbaterijne Battery-free	IP44	Biały White	Odbiornik / Receiver: 81 / 81 / 72 Nadajnik / Transmitter: 82 / 50 / 21,5

Togi AC



Dzwonek bezprzewodowy sieciowy
Wireless, mains-powered doorbell



Odbiornik: 230V~, 50Hz
Receiver: 230V~, 50Hz



Nadajnik: 1 x CR2032
Transmitter: 1 x CR2032



Funkcja learning system
Learning system technology



Zasięg: 200m
Range: 200m



Liczba dźwięków: 38
Number of sounds: 38



Regulacja głośności: 70-90dB
Volume control: 70-90dB









Symbol Product no.	EAN	Zasilanie odbiornika Power supply of receiver	Zasilanie nadajnika Power supply of transmitter	Zasięg Range	Stopień ochrony Protection level	Wymiary (szer./wys./gt. [mm]) Dimensions (W/H/D [mm])
OR-DB-MP-166/B	5908254826535	230V~, 50Hz	1x CR2032	200m	IP56	Odbiornik / Receiver: 86 / 86 / 66,5 Nadajnik / Transmitter: 89 / 36 / 29



Pela DC

Dzwonek bezprzewodowy bateryjny
Wireless, battery-powered doorbell

-  Odbiornik: 3 x AA
Receiver: 3 x AA
-  Nadajnik: 1 x CR2032
Transmitter: 1 x CR2032
-  Funkcja learning system
Learning system technology
-  Zasięg: 300m
Range: 300m
-  Liczba dźwięków: 60
Number of sounds: 60
-  3 tryby sygnalizacji
3 signaling modes
-  Regulacja głośności: 0-92dB
Volume control: 0-92dB



Symbol Product no.	EAN	Zasilanie odbiornika Power supply of receiver	Zasilanie nadajnika Power supply of transmitter	Zasięg Range	Stopień ochrony Protection level	Wymiary (szer./wys./gł. [mm]) Dimensions (W/H/D [mm])
DB-6/B	5908254842870	3 x AA	1x CR2032	300m	IP44	Odbiornik / Receiver: 81 / 81 / 34 Nadajnik / Transmitter: 36 / 66 / 18

Domofony

Audio doorphones

Erin

Zestaw domofonowy jednorodzinny, natynkowy
Single-family audio doorphone set, surface-mounted

ORNO
FOR HOME



Sterowanie furką
Wicket control



Sterowanie bramą
Gate opening



Szyfrator
Code lock



Czytnik breloków RFID: 13,56MHz
RFID reader: 13.56MHz



Montaż natynkowy
Surface mounting



Symbol Product no.	EAN	System łączenia Connection system	Liczba dźwięków Number of sounds	Regulacja głośności	Tryb cichy	Stopień ochrony Protection level	Wymiary (szer./wys./gł. [mm]) Dimensions (W/H/D [mm])
OR-DOM-BA-932/W	5908254842627	2-żyłowy 2-wires	1	✓	✓	IP65	Unifon / Indoor unit: 84 / 197 / 35 Panel zewnętrzny / Outdoor unit: 48 / 133 / 19

Sandi

Zestaw domofonowy jednorodzinny, natynkowy
Single-family audio doorphone set, surface-mounted

ORNO
FOR HOME



Bezsłuchawkowy
Handset-free



Sterowanie furką
Wicket control



Sterowanie bramą
Gate opening



Szyfrator
Code lock



Czytnik breloków RFID: 13,56MHz
RFID reader: 13.56MHz



Symbol Product no.	EAN	System łączenia Connection system	Liczba dźwięków Number of sounds	Regulacja głośności	Tryb cichy	Stopień ochrony Protection level	Wymiary (szer./wys./gł. [mm]) Dimensions (W/H/D [mm])
OR-DOM-BA-933/W	5908254842726	2-żyłowy 2-wires	12	✓	✓	IP65	Unifon / Indoor unit: 180 / 130 / 26 Panel zewnętrzny / Outdoor unit: 48 / 133 / 19

Wideodomofony

Video doorphones



ZORNO
FOR HOME

5 x RFID tags
5 x breloki RFID



OR-VID-MO-1076/W/S
montaż natynkowy
surface-mounted

OR-VID-MO-1076/W/F
montaż podtynkowy
flush-mounted

Guardo

Zestaw wideodomofonowy jednorodzinny z aplikacją mobilną
Single-family video doorphone set with mobile application



Zdalne sterowanie Wi-Fi
Remote control Wi-Fi



Łatwa instalacja: 4 żyły
Easy installation: 4 wires



Sterowanie furtką
Wicket control



Sterowanie bramą
Gate opening



Czytnik linii papilarnych
Fingerprint reader



Szyfrator
Code lock



Czytnik breloków RFID: 13,56MHz
RFID reader: 13.56MHz



Przekątna ekranu: 10"
Screen diagonal: 10"



Widzenie nocne: IR LED
Night light: IR LED



Możliwość rozbudowy zestawu
Expandable set

tuya
APPLICATION
TUYA SMART

FULL
HD
CAMERA
RESOLUTION

SD
CARD
READER









Wi Fi
WIFI
CONNECTION

Symbol Product no.	EAN	Wyświetlacz Display	Kąty (pion/poziom) Angles (V / H)	Sposób montażu Installation method	Stopień ochrony Protection level	Wymiary (szer./wys./gł. [mm]) Dimensions (W/H/D [mm])
OR-VID-MO-1076/W/F	5908254824203	10" LCD	54° / 107°	Podtynkowy Flush-mounted	IP65	Monitor / Monitor: 247 / 151,5 / 18 Panel zewnętrzny / Outdoor unit: 108 / 193 / 35
OR-VID-MO-1076/W/S	5908254825965	10" LCD	54° / 107°	Natynkowy Surface-mounted	IP65	Monitor / Monitor: 247 / 151,5 / 18 Panel zewnętrzny / Outdoor unit: 100 / 200 / 55

Lira

Zestaw wideodomofonowy jednorodzinny
Two-family video doorphone set

ORNO
FOR HOME

-  Ultra płaska obudowa
Ultra flat housing
-  Podświetlane dotykowe przyciski
Backlit touch buttons
-  Przekątna ekranu: 4,3"
Screen diagonal: 4,3"
-  Widzenie nocne: IR LED
Night light: IR LED
-  Sterowanie furtką
Wicket control
-  Łatwa instalacja: 4 żyły
Easy installation: 4 wires
-  Sterowanie bramą
Gate opening
-  Możliwość rozbudowy zestawu
Expandable set
-  Regulacja głośności
Volume control













Symbol Product no.	EAN	Wyświetlacz Display	Kąty (pion/poziom) Angles (V / H)	Liczba dźwięków Number of sounds	Stopień ochrony Protection level	Wymiary (szer./wys./gt. [mm]) Dimensions (W/H/D [mm])
VI-VID-RO-1077	5908254826573	4,3" LCD	48° / 68°	16	IP44	Monitor / Monitor: 133 / 103 / 19 Panel zewnętrzny / Outdoor unit: 65 / 143 / 41

Talos

Zestaw wideodomofonowy jednorodzinny z aplikacją mobilną
Single-family video doorphone set with mobile application



ORNO
FOR HOME

-  Łatwa instalacja: 4 żyły
Easy installation: 4 wires
-  Rozdzielczość kamery: 1920x1080
Camera resolution: 1920x1080
-  Zdalne sterowanie Wi-Fi
Remote control Wi-Fi
-  Czytnik breloków RFID: 125kHz
RFID reader: 125kHz
-  Dotykowy ekran
Touch-screen
-  Funkcja pamięci
Memory function
-  Sterowanie furtką
Wicket control
-  Widzenie nocne: IR LED
Night light: IR LED
-  Sterowanie bramą
Gate opening
-  Możliwość rozbudowy zestawu
Expandable set
-  Kąt widzenia: 55°/112°
View angle: 55°/112°



Symbol Product no.	EAN	Wyświetlacz Display	Kąty (pion/poziom) Angles (V / H)	Liczba dźwięków Number of sounds	Stopień ochrony Protection level	Wymiary (szer./wys./gt. [mm]) Dimensions (W/H/D [mm])
OR-VID-MS-1078	5908254840494	7" LCD	55° / 112°	6	IP65	Monitor / Monitor: 181 / 181 / 18 Panel zewnętrzny / Outdoor unit: 67 / 130 / 33



Pavonis

Zestaw wideodomofonowy jednorodzinny z aplikacją mobilną
Single-family video doorphone set with mobile application



Pavonis multi

Zestaw wideodomofonowy dwurodzinny z aplikacją mobilną
Two-family video doorphone set with mobile application



Łatwa instalacja: 4 żyły
Easy installation: 4 wires



Zdalne sterowanie Wi-Fi
Remote control Wi-Fi



Sterowanie furtką
Wicket control



Sterowanie bramą
Gate opening



Przekątna ekranu: 7"
Screen diagonal: 7"



Dotykowy ekran
Touch-screen



Rozdzielczość kamery: 1920x1080
Camera resolution: 1920x1080



Kąt widzenia: 54°/112°
View angle: 54°/112°



Czytnik breloków RFID: 125kHz
RFID reader: 125kHz



Widzenie nocne: IR LED
Night light: IR LED



Możliwość rozbudowy zestawu
Expandable set



APPLICATION
TUYA SMART



FULL
HD
CAMERA
RESOLUTION



SD CARD
READER



WIFI
CONNECTION

Symbol Product no.	EAN	Wyświetlacz Display	Kąty (pion/poziom) Angles (V / H)	Liczba dźwięków Number of sounds	Stopień ochrony Protection level	Wymiary (szer./wys./gł. [mm]) Dimensions (W/H/D [mm])
VDP-67	5908254828546	7" LCD	54° / 112°	6	IP55	Monitor / Monitor: 181 / 181 / 19 Panel zewnętrzny / Outdoor unit: 87 / 168 / 40
VDP-69	5908254843259	7" LCD	54° / 112°	6	IP65	Monitor / Monitor: 181 / 181 / 19 Panel zewnętrzny / Outdoor unit: 91 / 181 / 43

Setar

ViRONE
simple made easy.

Zestaw wideodomofonowy jednorodzinny
Single-family video doorphone set



Przekątna ekranu: 7"
Screen diagonal: 7"



Łatwa instalacja: 4 żyły
Easy installation: 4 wires



Sterowanie furtką
Wicket control



Sterowanie bramą
Gate opening



Widzenie nocne: IR LED
Night light: IR LED



Interkom
Intercom



Regulacja głośności
Volume control



Możliwość rozbudowy zestawu
Expandable set

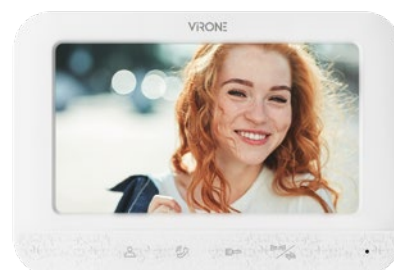

Symbol Product no.	EAN	Wyświetlacz Display	Kąty (pion/poziom) Angles (V / H)	Liczba dźwięków Number of sounds	Stopień ochrony Protection level	Wymiary (szer./wys./gł. [mm]) Dimensions (W/H/D [mm])
VDP-68/W	5908254829178	7" LCD	54° / 105°	1	IP44	Monitor / Monitor: 195 / 133 / 23 Panel zewnętrzny / Outdoor unit: 45 / 143 / 40

Ceti FULL HD

ViRONE
simple made easy.

Zestaw wideodomofonowy jednorodzinny
Single-family video doorphone set



Przekątna ekranu: 7"
Screen diagonal: 7"



Dotykowy ekran
Touch-screen



Sterowanie furtką
Wicket control



Sterowanie bramą
Gate opening



Rozdzielczość kamery: 1920x1080
Camera resolution: 1920x1080



Czytnik breloków RFID: 125kHz
RFID reader: 125kHz



Widzenie nocne: IR LED
Night light: IR LED



Kąt widzenia: 54°/112°
View angle: 54°/112°



Możliwość rozbudowy zestawu
Expandable set



SD
SD CARD
READER

**FULL
HD**
CAMERA
RESOLUTION

Symbol Product no.	EAN	Wyświetlacz Display	Kąty (pion/poziom) Angles (V / H)	Liczba dźwięków Number of sounds	Stopień ochrony Protection level	Wymiary (szer./wys./gł. [mm]) Dimensions (W/H/D [mm])
VDP-60FHD	5908254843303	7" LCD	54° / 112°	6	IP55	Monitor / Monitor: 181 / 181 / 19 Panel zewnętrzny / Outdoor unit: 87 / 168 / 40

Klamki i nakładki sztywne

Smart handles and door locks

ORNO
FOR HOME

Klamka z zamkiem szyfrowym

Smart handle with code lock

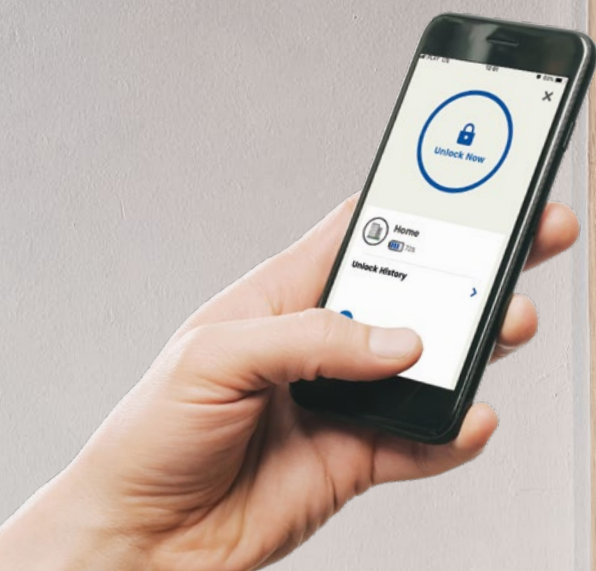

Stopień ochrony: IP44
Ingress protection: IP44



Aplikacja: Janus Lock
App: Janus Lock



Standard komunikacji: Bluetooth 4.0
Communication standard: Bluetooth 4.0



Wbudowany szyfikator
Code lock



Możliwość nadania dostępu stałego i tymczasowego
Possibility of permanent and temporary access



Materiał: stal nierdzewna
Material: stainless steel



OR-ZS-850



OR-ZS-850/B



FREE APP
AVAILABLE

Symbol Product no.	EAN	Zasilanie Power supply	Stopień ochrony Protection level	Tryb pracy Working modes	Grubość drzwi [mm] Door thickness [mm]	Kolor Color
OR-ZS-850	5908254802133	2 x CR2	IP44	Bluetooth + kod Bluetooth + code	38-58	Srebrny Silver
OR-ZS-850/B	5908254828560	2 x CR2	IP44	Bluetooth + kod Bluetooth + code	38-58	Czarny Black

Klamka szyfrowa z klawiaturą dotykową i czytnikiem linii papilarnych

Smart handle with touch keypad and fingerprints reader

ViRONE
simple made easy.



Aplikacja: Tuya
App: Tuya



Standard komunikacji:
Bluetooth 4.0
Communication standard:
Bluetooth 4.0



Wbudowany szyfrator
Code lock



Czytnik linii papilarnych
Fingerprint reader



Możliwość nadania dostępu stałego i tymczasowego
Possibility of permanent and temporary access



Otwieranie awaryjne
Emergency unlocking



Zasilanie awaryjne:
gniazdo USB-C
Emergency power supply:
USB-C port



Powered by
tuya
Intelligence
Inside

FREE APP
AVAILABLE

Symbol Product no.	EAN	Zasilanie Power supply	Stopień ochrony Protection level	Tryb pracy Working modes	Grubość drzwi [mm] Door thickness [mm]	Kolor Color
CDL-1/B	5908254826801	4 x AAA	IP20	Bluetooth + kod + czytnik linii papilarnych Bluetooth + code + fingerprint reader	35-50	Czarny Black

Zamek szyfrowy dotykowy z czytnikiem kart i breloków zbliżeniowych

Code lock with touch keypad, proximity tags and cards

ORNO
FOR HOME



Czytnik kart i breloków zbliżeniowych
Proximity tags and cards reader



Ilość wyjść przekaźnikowych: 2
Number of relay outputs: 2



Częstotliwość: 125kHz
Frequency: 125kHz

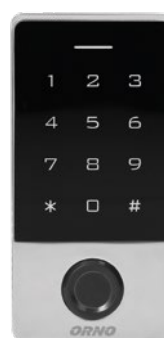

Symbol Product no.	EAN	Zasilanie Power supply	Stopień ochrony Protection level	Maksymalna ilość użytkowników Max. number of users	Ilość wyjść przekaźnikowych Number of relay outputs	Wymiary (szer./wys./gł. [mm]) Dimensions (W/H/D [mm])
OR-ZS-827	5908254822711	12V DC	IP68	2000	2	70 / 140 / 24

Nakładka na zamek z szyfratorem i czytnikiem linii papilarnych

Smart door lock with fingerprints reader and code lock

ORNO
FOR HOME

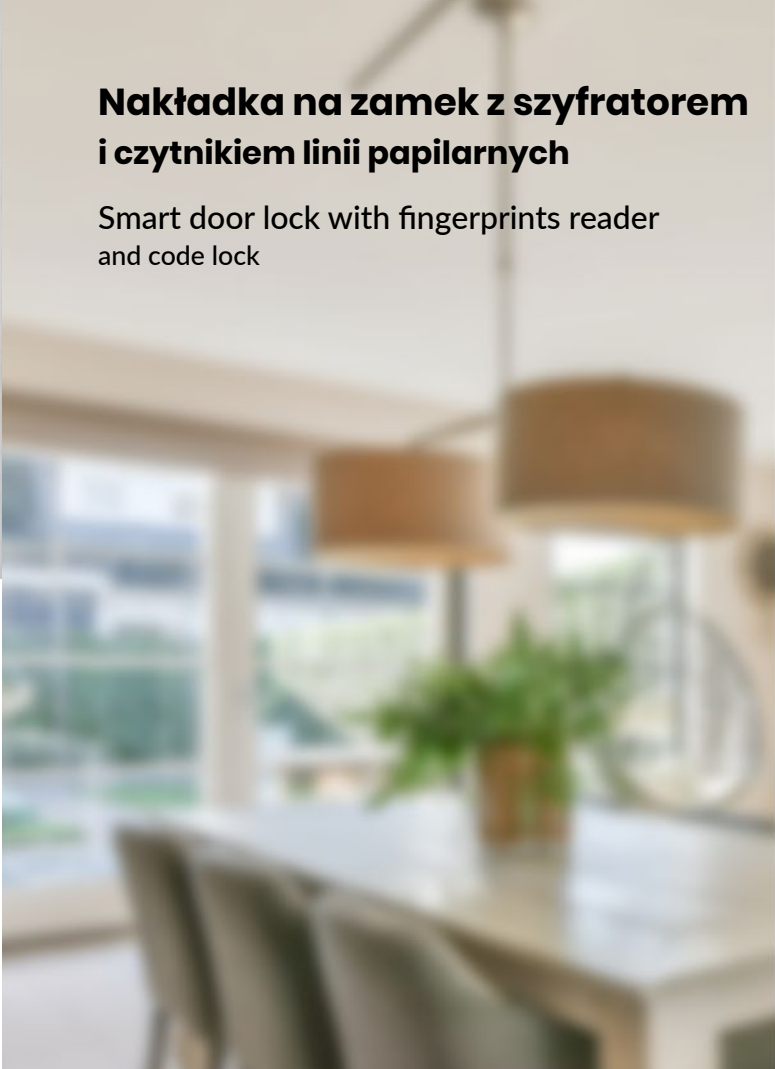

Aplikacja: Janus Lock
App: Janus Lock



Standard komunikacji: Bluetooth 4.0
Communication standard: Bluetooth 4.0



Wbudowany szyfrator
Code lock



Czytnik linii papilarnych
Fingerprint reader



Możliwość nadania dostępu stałego i tymczasowego
Possibility of permanent and temporary access



Otwieranie awaryjne
Emergency unlocking



Zasilanie awaryjne: gniazdo USB-C
Emergency power supply: USB-C port



OR-ZS-854

OR-ZS-855



Symbol Product no.	EAN	Zasilanie Power supply	Stopień ochrony Protection level	Tryb pracy Working modes	Maksymalna ilość użytkowników Max. number of users	Wymiary (szer./wys./gł. [mm]) Dimensions (W/H/D [mm])
OR-ZS-854	5908254823497	4 x AA	IP44	Bluetooth + kod + czytnik linii papilarnych Bluetooth + code + fingerprint reader	100	70 / 141 / 52
OR-ZS-855	5908254823503	4 x AA	IP44	Bluetooth + kod + czytnik linii papilarnych Bluetooth + code + fingerprint reader	100	70 / 292 / 75,5

Atrapy kamer

Dummy cameras

VIRONE
simple made easy.



CD-2/G



Mrugająca czerwona dioda
Flashing red diode



Panel solarny
Solar panel



CD-3/B



Mrugająca czerwona dioda
Flashing red diode



CD-3/G



Mrugająca czerwona dioda
Flashing red diode



CD-4



Mrugająca czerwona dioda
Flashing red diode



CD-6



Naświetlacz IR
IR light



CD-7



Mrugająca czerwona dioda
Flashing red diode

Symbol Product no.	EAN	Zasilanie Power supply	Kolor Color	Wymiary kamery (szer./wys./gł. [mm]) Camera dimensions (W/H/D [mm])	Wymiary bazy montażowej (szer./wys./gł. [mm]) Mounting base dimensions (W/H/D [mm])
CD-2/G	5908254828775	2 x AA	Srebrny Silver	178 / Ø 70	80 / 80 / 124
CD-3/B	5908254828782	2 x AA	Czarny Black	169 / Ø 70	80 / 80 / 124
CD-3/G	5908254843372	2 x AA	Srebrny Silver	169 / Ø 70	80 / 80 / 124
CD-4	5908254828799	3 x AAA	Czarny Black	Ø99,5 / 72	-
CD-6	5908254842429	2 x AA	Biały White	Ø125 / 90	-
CD-7	5908254842856	3 x AA	Biały White	Ø125 / 100	-

Bezprzewodowa kamera monitorująca IP

External wireless IP camera



APPLICATION
TUYA SMART



CAMERA
RESOLUTION



SD CARD
READER



Rozdzielczość: 1920x1080

Resolution: 1920x1080



Widzenie nocne: IR LED

Night light: IR LED

Symbol Product no.	EAN	Zasilanie Power supply	Rozdzielczość Resolution	Kąty (pion/poziom) Angles (V / H)	Stopień ochrony Protection level	Rodzaj transmisji Type of transmission	Wymiary (szer./wys./gt. [mm]) Dimensions (W/H/D [mm])
OR-MT-ME-1809	5908254823350	Akumulator/ Battery: 5200mAh	1920x1080	41° / 81°	IP65	Wi-Fi	55 / 102 / 55

Panel solarny do zasilania kamery OR-MT-ME-1809

Solar panel for camera charging OR-MT-ME-1809

Symbol Product no.	EAN	Rodzaj ogniwa Cell type	Moc MPP MPP power by STC	Napięcie MPP MPP voltage	Prąd MPP MPP current	Wymiary (szer./wys./gt. [mm]) Dimensions (W/H/D [mm])
OR-MT-ME-1809PS	5908254823480	Monokrystaliczne Monocrystalline	3,3W	5V	660 mA	189 / 17 / 150



Kolorowa kamera przewodowa CCTV

do rozbudowy zestawów wideodomofonowych



Wired color CCTV camera

for video doorphone sets



Rozdzielczość: 1920x1080

Resolution: 1920x1080



Widzenie nocne: IR LED

Night light: IR LED



Stopień ochrony: IP65

Ingress protection: IP65



Maks zasięg w podczerwieni: 15m

Max. infrared range: 15m



AHD
TVI
CVI
CVBS
WORK MODES

Symbol Product no.	EAN	Zasilanie Power supply	Rozdzielczość Resolution	Kąty (pion/poziom) Angles (V / H)	Stopień ochrony Protection level	System łączenia Connection system	Wymiary (szer./wys./gt. [mm]) Dimensions (W/H/D [mm])
OR-MT-BC-1811	5908254842900	12V DC	1920x1080	23° / 48°	IP65	Przewód 4-żyłowy 4-wires installation	68 / 180 / 68

Czujniki tlenku węgla









Carbon monoxide sensors

Baterijny czujnik tlenku węgla

Battery-operated carbon monoxide detector

ORNO
FOR PROFESSIONALS



-  Bateria w zestawie: 1 x 9V DC
1 x 9V DC included in set
-  Przycisk TEST
Test button
-  Wyciszenie alarmu
Alarm mute
-  Sygnalizacja niskiego stanu baterii
Low battery indication
-  Sygnalizacja awarii
Fault indication
-  Sygnalizacja końca okresu eksploatacji
End-life indication
-  Funkcja pamięci
Memory function
-  Produkt OR-DC-633-TEST
testowany w Polsce
OR-DC-633-TEST product
tested in Poland



Symbol Product no.	EAN	Zasilanie Power supply	Typ czujnika Sensor type	Poziom głośności [dB] Alarm volume [dB]	Żywność Lifetime	Spełniane normy Compliance with standards	Wymiary (szer./wys./gt. [mm]) Dimensions (W/H/D [mm])
OR-DC-633	5908254827297	1 x 9V DC	Elektrochemiczny Electrochemical	85/3m	7 lat 7 years	EN 50291-1:2018	124 / 82 / 36
OR-DC-633-TEST	5908254827860	1 x 9V DC	Elektrochemiczny Electrochemical	85/3m	7 lat 7 years	EN 50291-1:2018	124 / 82 / 36

Bezdotykowy włącznik podtynkowy

Flush-mounted touchless switch

ORNO
FOR PROFESSIONALS



Włącznik bezdotykowy
Touchless switch



Montaż podtynkowy
Flush mounting



Symbol Product no.	EAN	Napięcie nominalne Nominal voltage	Maksymalne obciążenie Max. load	Zasięg detekcji Detection range	Stopień ochrony Protection level	Wymiary (szer./wys./gł. [mm]) Dimensions (W/H/D [mm])
OR-CR-268	5908254824067	230V~, 50Hz	1200W	5-6cm	IP20	80 / 80 / 36,6

Bezprzewodowy bezbateryjny włącznik z odbiornikiem

Wireless, battery-free switch with receiver

ViRONE
simple made easy.



Częstotliwość: 433MHz
Frequency: 433MHz



Możliwość rozbudowy
Expandable set



Odbiornik/Receiver

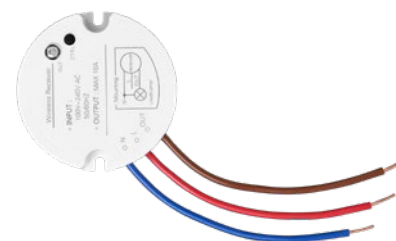

Nadajnik/Transmitter

Symbol Product no.	EAN	Napięcie nominalne Nominal voltage	Maksymalne obciążenie Max. load	Zasięg detekcji Detection range	Materiał Material	Wymiary (szer./wys./gł. [mm]) Dimensions (W/H/D [mm])
WB-1	5908254822636	230V~, 50Hz	2300W	80m	Poliwęglan Polycarbon	Odbiornik/Receiver: 50 / 50 / 22,6 Nadajnik/Transmitter: 86 / 86 / 17,4





Oświetlenie

Lighting

Nowości produktowe
New products

2023/2024

Plafony bez czujnika ruchu z wymiennym źródłem światła

Ceiling lights without motion sensor with replaceable light source

ViRONE
simple made easy.



Źródło światła: E27

Light source: E27



Moc: 2x60W

Power: 2x60W



Stopień ochrony: IK07

Impact protection: IK07

Symbol Product no.	EAN	Napięcie nominalne Nominal voltage	Źródło światła Light source	Moc Power	Materiał klosza Lampshade material	Stopień ochrony IP Ingress protection IP	Kolor obudowy Housing color	Średnica / wysokość [mm] Diameter / height [mm]
CL/2XE27-8	5908254841408	230V~, 50Hz	2 x E27	2 x 60W	Tworzywo sztuczne matowe/satynowe Matt/satin plastic	IP20	Biały White	Ø 325 / 85
CL/2XE27-10/W	5908254841422	230V~, 50Hz	2 x E27	2 x 60W	Tworzywo sztuczne matowe/satynowe Matt/satin plastic	IP54	Biały White	Ø 305 / 90
CL/2XE27-10/B	5908254841439	230V~, 50Hz	2 x E27	2 x 60W	Tworzywo sztuczne matowe/satynowe Matt/satin plastic	IP54	Czarny Black	Ø 305 / 90
CL/2XE27-10/G	5908254841446	230V~, 50Hz	2 x E27	2 x 60W	Tworzywo sztuczne matowe/satynowe Matt/satin plastic	IP54	Szary Grey	Ø 305 / 90
CL/2XE27-11	5908254841484	230V~, 50Hz	2 x E27	2 x 60W	Tworzywo sztuczne matowe/satynowe Matt/satin plastic	IP20	Biały White	275 / 275 / 75



Nabu



CL/2XE27-8

Mangala



CL/2XE27-11

Selene



CL/2XE27-10/W



CL/2XE27-10/B



CL/2XE27-10/G

Plafony bez czujnika ruchu ze zintegrowanym źródłem światła LED

Ceiling lights without motion sensor with integrated LED light source

Adviti
LIGHTING SOLUTIONS



Źródło światła: LED
Light source: LED



Temperatura barwowa: 4000K
Color temperature: 4000K



Barwa światła: Neutralny biały
Light color: Neutral white

Symbol	EAN	Napięcie nominalne	Moc	Strumień świetlny	Temperatura barwowa	Barwa światła	Wskaźnik oddawania barw Ra/CRI
Product no.		Nominal voltage	Power	Luminous flux	Color temperature	Light color	Color rendering index Ra/CRI
AD-PL-6459WLZM4	5908254840388	230V~, 50Hz	12W	1190lm	4000K	Neutralny biały Neutral white	80
AD-PL-6460WLZM4	5908254840401	230V~, 50Hz	18W	1880lm	4000K	Neutralny biały Neutral white	80
AD-PL-6461WLZM4	5908254840425	230V~, 50Hz	24W	2565lm	4000K	Neutralny biały Neutral white	80
AD-PL-6468WLPM4	5908254840814	230V~, 50Hz	18W	1880lm	4000K	Neutralny biały Neutral white	80
AD-PL-6469WLPM4	5908254840838	230V~, 50Hz	24W	2565lm	4000K	Neutralny biały Neutral white	80
AD-PL-6470WLPM4	5908254840852	230V~, 50Hz	30W	3225lm	4000K	Neutralny biały Neutral white	80
AD-PL-6471WLPM4	5908254840876	230V~, 50Hz	18W	1880lm	4000K	Neutralny biały Neutral white	80
AD-PL-6472WLPM4	5908254840883	230V~, 50Hz	30W	3225lm	4000K	Neutralny biały Neutral white	80



Sopot



AD-PL-6459WLZM4
AD-PL-6460WLZM4
AD-PL-6461WLZM4

Jantar



AD-PL-6468WLPM4
AD-PL-6469WLPM4
AD-PL-6470WLPM4

Rewa



AD-PL-6471WLPM4
AD-PL-6472WLPM4

Materiał klosza Lampshade material	Stopień ochrony IP Ingress protection IP	Klasa IK (odporność na uderzenia) Impact protection IK	Kolor obudowy Housing color	Średnica / wysokość [mm] Diameter / height [mm]
PVC	IP20	IK05	Biały White	Ø 260 / 58
PVC	IP20	IK05	Biały White	Ø 350 / 62
PVC	IP20	IK05	Biały White	Ø 380 / 52
PC	IP54	IK08	Biały White	Ø 220 / 51
PC	IP54	IK08	Biały White	Ø 280 / 51
PC	IP54	IK08	Biały White	Ø 330 / 51
PC	IP65	IK08	Biały White	Ø 250 / 47,5
PC	IP65	IK08	Biały White	Ø 350 / 47,5

Plafony z czujnikiem ruchu

i wymiennym źródłem światła

Ceiling lights with motion sensor and replaceable light source

ViRONE
simple made easy.



Źródło światła: E27

Light source: E27



Czujnik ruchu

Motion sensor



Kąt detekcji: 360°

Detection angle: 360°

Symbol	EAN	Napięcie nominalne	Źródło światła	Moc	Stopień ochrony IP	Materiał klosza	Klasa IK (odporność na uderzenia)	Kolor obudowy	Czujnik ruchu	Zasięg detekcji
Product no.		Nominal voltage	Light source	Power	Ingress protection IP	Lampshade material	Impact protection IK	Housing color	Motion sensor	Detection range
CL/2XE27R-2	5908254813184	230V~, 50Hz	2 x E27	2 x 25W	IP20	PC	IK06	Biały White	PIR	Ø 1-6m
CL/2XE27R-9	5908254841415	230V~, 50Hz	2 x E27	2 x 60W	IP44	Tworzywo sztuczne matowe/satynowe Matt/satin plastic	IK07	Biały White	PIR	Ø 1-6m
CL/2XE27-10MV/W	5908254841453	230V~, 50Hz	2 x E27	2 x 60W	IP54	Tworzywo sztuczne matowe/satynowe Matt/satin plastic	IK07	Biały White	Mikrofalowy Microwave	Ø 1-4m
CL/2XE27-10MV/B	5908254841460	230V~, 50Hz	2 x E27	2 x 60W	IP54	Tworzywo sztuczne matowe/satynowe Matt/satin plastic	IK07	Czarny Black	Mikrofalowy Microwave	Ø 1-4m
CL/2XE27-10MV/G	5908254841477	230V~, 50Hz	2 x E27	2 x 60W	IP54	Tworzywo sztuczne matowe/satynowe Matt/satin plastic	IK07	Szary Grey	Mikrofalowy Microwave	Ø 1-4m



Rovo PC



CL/2XE27R-2

Selene



CL/2XE27-10MV/W

Asteria



CL/2XE27R-9



CL/2XE27-10MV/G



CL/2XE27-10MV/B

Regulacja natężenia światła LUX	Regulacja czasu świecenia TIME	Średnica / wysokość [mm]
Adjustable daylight sensor LUX	Adjustable time setting TIME	Diameter / height [mm]
<3 - 2000lux	min: 10 s ± 3 s; max: 3 min. ± 30 s	Ø 300 / 96,8
<15 - 2000lux	2s - 20min	Ø 330 / 85
2lux, 10lux, 25lux, 50lux, off	5s, 30s, 1min, 3min, 5min, 10min, 20min, 30min	Ø 305 / 90
2lux, 10lux, 25lux, 50lux, off	5s, 30s, 1min, 3min, 5min, 10min, 20min, 30min	Ø 305 / 90
2lux, 10lux, 25lux, 50lux, off	5s, 30s, 1min, 3min, 5min, 10min, 20min, 30min	Ø 305 / 90

Plafony z czujnikiem ruchu i zintegrowanym źródłem światła LED

Ceiling lights with motion sensor and integrated LED light source

Adviti
LIGHTING SOLUTIONS



Źródło światła: LED
Light source: LED



Czujnik ruchu: mikrofalowy
Motion sensor: microwave



Temperatura barwowa: 4000K
Color temperature: 4000K



Barwa światła: Neutralny biały
Light color: Neutral white



Symbol	EAN	Napięcie nominalne	Źródło światła	Moc	Strumień świetlny	Temperatura barwowa	Barwa światła	Wskaźnik oddawania barw Ra/CRI	Stopień ochrony IP
Product no.		Nominal voltage	Light source	Power	Luminous flux	Color temperature	Light color	Color rendering index Ra/CRI	Ingress protection IP
AD-PL-6459WLZMM4	5908254840395	230V~, 50Hz	LED	12W	1190lm	4000K	Neutralny biały Neutral white	80	IP20
AD-PL-6460WLZMM4	5908254840418	230V~, 50Hz	LED	18W	1880lm	4000K	Neutralny biały Neutral white	80	IP20
AD-PL-6461WLZMM4	5908254840432	230V~, 50Hz	LED	24W	2565lm	4000K	Neutralny biały Neutral white	80	IP20
AD-PL-6468WLPMM4	5908254840821	230V~, 50Hz	LED	18W	1880lm	4000K	Neutralny biały Neutral white	80	IP54
AD-PL-6469WLPMM4	5908254840845	230V~, 50Hz	LED	24W	2565lm	4000K	Neutralny biały Neutral white	80	IP54

Sopot



AD-PL-6459WLZMM4
AD-PL-6460WLZMM4
AD-PL-6461WLZMM4

Jantar



AD-PL-6468WLPMM4
AD-PL-6469WLPMM4



Materiał klosza	Klasa IK (odporność na uderzenia)	Kolor obudowy	Czujnik ruchu	Kąt detekcji	Zasięg detekcji	Regulacja natężenia światła LUX	Regulacja czasu świecenia TIME	Średnica / wysokość [mm]
Lampshade material	Impact protection IK	Housing color	Motion sensor	Detection angle	Detection range	Adjustable daylight sensor LUX	Adjustable time setting TIME	Diameter / height [mm]
PVC	IK05	Biały White	Mikrofalowy Microwave	360°	Ø 3-7m	15lux	40s	Ø 260 / 58
PVC	IK05	Biały White	Mikrofalowy Microwave	360°	Ø 3-7m	15lux	40s	Ø 350 / 62
PVC	IK05	Biały White	Mikrofalowy Microwave	360°	Ø 3-7m	15lux	40s	Ø 380 / 52
PC	IK08	Biały White	Mikrofalowy Microwave	360°	Ø 3-7m	15lux	40s	Ø 220 / 51
PC	IK08	Biały White	Mikrofalowy Microwave	360°	Ø 3-7m	15lux	40s	Ø 280 / 51

Źródła światła

Light sources



ViRONE
simple made easy.

Żarówki z czujnikiem ruchu

LED bulbs with motion sensor



Typ bańki: A60
Bulb type: A60



Trzonek: E27
Thread: E27



Czujnik ruchu
Motion sensor



Temperatura barwowa: 4000K
Color temperature: 4000K



Barwa światła: Neutralny biały
Light color: Neutral white



Wskaźnik oddawania barw Ra/CRI: > 80
Color rendering index Ra/CRI: > 80



SW/R-3



SW/R-4



SW/MV-5

Symbol Product no.	EAN	Napięcie nominalne Nominal voltage	Źródło światła Light source	Moc Power	Strumień świetlny Luminous flux	Czujnik ruchu Motion sensor	Kąt detekcji Detection angle	Zasięg detekcji Detection range
SW/R-3	5908254819292	230V~, 50Hz	LED SMD	7W	600lm	PIR	360°	Ø 1-6m
SW/R-4	5908254822704	230V~, 50Hz	LED SMD	12W	1480lm	PIR	360°	Ø 1-6m
SW/MV-5	5908254824135	230V~, 50Hz	LED	7W	825lm	Mikrofalowy Microwave	360°	Ø 1-10m

Astar LED

Oprawa liniowa podszafkowa
Linear light



AD-OL-6425LZM4



AD-OL-6426LZM4



AD-OL-6427LZM4



AD-OL-6428LZM4

Oprawa liniowa podszafkowa z przewodem zasilającym
Linear light with power cable



AD-OL-6425LZM4/PZ



AD-OL-6426LZM4/PZ



AD-OL-6427LZM4/PZ



AD-OL-6428LZM4/PZ



Temperatura barwowa: 4000K
Color temperature: 4000K



Barwa światła: Neutralny biały
Light color: Neutral white



Możliwość łączenia
Combination possibility

Przewód zasilający
Power cable



AD-OL-6458PZ

Przewód łączeniowy
Connection cable



AD-OL-6099CN

Symbol Product no.	EAN	Napięcie nominalne Nominal voltage	Źródło światła Light source	Strumień świetlny Luminous flux	Kabel zasilający Power cable	Materiał Material	Wymiary (szer./wys./gł) [mm] Dimensions (W/H/D) [mm]
AD-OL-6425LZM4	5908254829215	230V~, 50Hz	4W	360lm	-	Tworzywo sztuczne matowe/satynowe Matt/satin plastic	305 / 22 / 32
AD-OL-6425LZM4/PZ	5908254840371	230V~, 50Hz	4W	360lm	100cm	Tworzywo sztuczne matowe/satynowe Matt/satin plastic	305 / 22 / 32
AD-OL-6426LZM4	5908254842740	230V~, 50Hz	7W	630lm	-	Tworzywo sztuczne matowe/satynowe Matt/satin plastic	570 / 22 / 32
AD-OL-6426LZM4/PZ	5908254829222	230V~, 50Hz	7W	630lm	100cm	Tworzywo sztuczne matowe/satynowe Matt/satin plastic	570 / 22 / 32
AD-OL-6427LZM4	5908254842757	230V~, 50Hz	12W	1080lm	-	Tworzywo sztuczne matowe/satynowe Matt/satin plastic	870 / 22 / 32
AD-OL-6427LZM4/PZ	5908254829239	230V~, 50Hz	12W	1080lm	100cm	Tworzywo sztuczne matowe/satynowe Matt/satin plastic	870 / 22 / 32
AD-OL-6428LZM4	5908254842764	230V~, 50Hz	14W	1260lm	-	Tworzywo sztuczne matowe/satynowe Matt/satin plastic	1170 / 22 / 32
AD-OL-6428LZM4/PZ	5908254829246	230V~, 50Hz	14W	1260lm	100cm	Tworzywo sztuczne matowe/satynowe Matt/satin plastic	1170 / 22 / 32
AD-OL-6458PZ	5908254840609	230V~, 50Hz	-	-	100cm	Tworzywo sztuczne Plastic	-
AD-OL-6099CN	5908254817908	230V~, 50Hz	-	-	16cm	Tworzywo sztuczne Plastic	-

Lampy ścienna-sufitowe

Wall and ceiling lights



AD-OP-6193WGU10



AD-OP-6348WGU10



AD-OP-6194WGU10



AD-OP-6195WGU10



AD-OP-6248WGU10



AD-OP-6277WGU10



AD-OP-6278WGU10



AD-OP-6279WGU10



Doa

Oprawy ścienna-sufitowe
Wall and ceiling lights



Źródło światła: GU10
Light source: GU10



Materiał lampy: Stal
Lamp material: Steel



Regulacja kąta
Angle adjustment

Symbol Product no.	EAN	Napięcie nominalne Nominal voltage	Źródło światła Light source	Moc Power	Materiał lampy Lamp material	Kolor obudowy Housing color	Wymiary (szer./wys./gł) [mm] Dimensions (W/H/D) [mm]
AD-OP-6193WGU10	5908254818097	230V~, 50Hz	1x GU10	50W	Stal Steel	Biały White	Ø 80 / 140
AD-OP-6194WGU10	5908254818110	230V~, 50Hz	2x GU10	2x 50W	Stal Steel	Biały White	200 / 140 / 160
AD-OP-6195WGU10	5908254818134	230V~, 50Hz	3x GU10	3x 50W	Stal Steel	Biały White	400 / 140 / 60
AD-OP-6348WGU10	5908254828041	230V~, 50Hz	4x GU10	4x 50W	Stal Steel	Biały White	190 / 140 / 190
AD-OP-6248WGU10	5908254825279	230V~, 50Hz	4x GU10	4x 50W	Stal Steel	Biały White	560 / 140 / 60
AD-OP-6277WGU10	5908254826849	230V~, 50Hz	6x GU10	6x 50W	Stal Steel	Biały White	550 / 140 / 60
AD-OP-6278WGU10	5908254826863	230V~, 50Hz	8x GU10	8x 50W	Stal Steel	Biały White	750 / 140 / 60
AD-OP-6279WGU10	5908254826870	230V~, 50Hz	10x GU10	10x 50W	Stal Steel	Biały White	950 / 140 / 60



AD-OP-6348BGU10



AD-OP-6193BGU10



AD-OP-6248BGU10



AD-OP-6195BGU10



AD-OP-6194BGU10



AD-OP-6278BGU10



AD-OP-6277BGU10



AD-OP-6279BGU10



Źródło światła: GU10
Light source: GU10



Materiał lampy: Stal
Lamp material: Steel



Regulacja kąta
Angle adjustment

Symbol Product no.	EAN	Napięcie nominalne Nominal voltage	Źródło światła Light source	Moc Power	Materiał lampy Lamp material	Kolor obudowy Housing color	Wymiary (szer./wys./gł) [mm] Dimensions (W/H/D) [mm]
AD-OP-6193BGU10	5908254818080	230V~, 50Hz	1x GU10	50W	Stal Steel	Czarny Black	Ø 80 / 140
AD-OP-6194BGU10	5908254818103	230V~, 50Hz	2x GU10	2x 50W	Stal Steel	Czarny Black	200 / 140 / 160
AD-OP-6195BGU10	5908254818127	230V~, 50Hz	3x GU10	3x 50W	Stal Steel	Czarny Black	400 / 140 / 60
AD-OP-6348BGU10	5908254828034	230V~, 50Hz	4x GU10	4x 50W	Stal Steel	Czarny Black	190 / 140 / 190
AD-OP-6248BGU10	5908254825262	230V~, 50Hz	4x GU10	4x 50W	Stal Steel	Czarny Black	560 / 140 / 60
AD-OP-6277BGU10	5908254826832	230V~, 50Hz	6x GU10	6x 50W	Stal Steel	Czarny Black	550 / 140 / 60
AD-OP-6278BGU10	5908254826856	230V~, 50Hz	8x GU10	8x 50W	Stal Steel	Czarny Black	750 / 140 / 60
AD-OP-6279BGU10	5908254826887	230V~, 50Hz	10x GU10	10x 50W	Stal Steel	Czarny Black	950 / 140 / 60

Malta

Oprawy ścienna-sufitowe
Wall and ceiling lights



AD-OP-6478WGU10



AD-OP-6479WGU10



AD-OP-6480WGU10



ON/OFF



AD-OP-6481WGU10



AD-OP-6482WGU10



AD-OP-6485WGU10



AD-OP-6483WGU10



AD-OP-6484WGU10



AD-OP-6486WGU10



AD-OP-6478BGU10



AD-OP-6479BGU10



AD-OP-6480BGU10



ON/OFF



AD-OP-6481BGU10



AD-OP-6482BGU10



AD-OP-6485BGU10



AD-OP-6483BGU10



AD-OP-6484BGU10



AD-OP-6486BGU10



Źródło światła: GU10

Light source: GU10



Regulacja kąta

Angle adjustment



Materiał klosza: Aluminium

Material cover: Aluminium

Symbol Product no.	EAN	Napięcie nominalne Nominal voltage	Źródło światła Light source	Moc Power	Materiał lampy Lamp material	Kolor obudowy Housing color	Wymiary (szer./wys./gł) [mm] Dimensions (W/H/D) [mm]	Włącznik ON/OFF ON/OFF switch
AD-OP-6478WGU10	5908254841491	230V~, 50Hz	1 x GU10	1 x 12W	Aluminium	Biały White	Ø 80 / 112	
AD-OP-6478BGU10	5908254841507	230V~, 50Hz	1 x GU10	1 x 12W	Aluminium	Czarny Black	Ø 80 / 112	
AD-OP-6479WGU10	5908254841514	230V~, 50Hz	1 x GU10	1 x 12W	Aluminium	Biały White	Ø 62 / 115	
AD-OP-6479BGU10	5908254841521	230V~, 50Hz	1 x GU10	1 x 12W	Aluminium	Czarny Black	Ø 62 / 115	
AD-OP-6480WGU10	5908254841538	230V~, 50Hz	1 x GU10	1 x 12W	Aluminium	Biały White	80 / 110 / 160	✓
AD-OP-6480BGU10	5908254841545	230V~, 50Hz	1 x GU10	1 x 12W	Aluminium	Czarny Black	80 / 110 / 160	✓
AD-OP-6481WGU10	5908254841552	230V~, 50Hz	2 x GU10	2 x 12W	Aluminium	Biały White	65 / 125 / 220	
AD-OP-6481BGU10	5908254841569	230V~, 50Hz	2 x GU10	2 x 12W	Aluminium	Czarny Black	65 / 125 / 220	
AD-OP-6482WGU10	5908254841576	230V~, 50Hz	3 x GU10	3 x 12W	Aluminium	Biały White	65 / 125 / 390	
AD-OP-6482BGU10	5908254841583	230V~, 50Hz	3 x GU10	3 x 12W	Aluminium	Czarny Black	65 / 125 / 390	
AD-OP-6483WGU10	5908254841590	230V~, 50Hz	3 x GU10	3 x 12W	Aluminium	Biały White	200 / 125 / 200	
AD-OP-6483BGU10	5908254841606	230V~, 50Hz	3 x GU10	3 x 12W	Aluminium	Czarny Black	200 / 125 / 200	
AD-OP-6484WGU10	5908254841613	230V~, 50Hz	3 x GU10	3 x 12W	Aluminium	Biały White	Ø 220 / 125	
AD-OP-6484BGU10	5908254841620	230V~, 50Hz	3 x GU10	3 x 12W	Aluminium	Czarny Black	Ø 220 / 125	
AD-OP-6485WGU10	5908254841637	230V~, 50Hz	4 x GU10	4 x 12W	Aluminium	Biały White	65 / 125 / 600	
AD-OP-6485BGU10	5908254841644	230V~, 50Hz	4 x GU10	4 x 12W	Aluminium	Czarny Black	65 / 125 / 600	
AD-OP-6486WGU10	5908254841651	230V~, 50Hz	4 x GU10	4 x 12W	Aluminium	Biały White	200 / 125 / 200	
AD-OP-6486BGU10	5908254841668	230V~, 50Hz	4 x GU10	4 x 12W	Aluminium	Czarny Black	200 / 125 / 200	

Rio

Oprawy ścienna-sufitowe
Wall and ceiling lights



Źródło światła: E27
Light source: E27



Regulacja kąta
Angle adjustment



AD-OP-6429WE27



AD-OP-6430WE27



AD-OP-6431WE27



AD-OP-6436WE27



AD-OP-6432WE27



AD-OP-6433WE27



AD-OP-6434WE27



AD-OP-6435WE27

Symbol Product no.	EAN	Napięcie nominalne Nominal voltage	Źródło światła Light source	Moc Power	Materiał lampy Lamp material	Kolor obudowy Housing color	Wymiary (szer./wys./gł) [mm] Dimensions (W/H/D) [mm]
AD-OP-6429WE27	5908254829475	230V~, 50Hz	1 x E27	1 x 60W	Stal Steel	Biały White	165 / 50 / 25
AD-OP-6430WE27	5908254829499	230V~, 50Hz	2 x E27	2 x 60W	Stal Steel	Biały White	300 / 50 / 25
AD-OP-6436WE27	5908254829611	230V~, 50Hz	3 x E27	3 x 60W	Stal Steel	Biały White	Ø 190 / 25
AD-OP-6431WE27	5908254829512	230V~, 50Hz	3 x E27	3 x 60W	Stal Steel	Biały White	480 / 50 / 25
AD-OP-6432WE27	5908254829536	230V~, 50Hz	4 x E27	4 x 60W	Stal Steel	Biały White	630 / 50 / 25
AD-OP-6433WE27	5908254829550	230V~, 50Hz	6 x E27	6 x 60W	Stal Steel	Biały White	630 / 50 / 25
AD-OP-6434WE27	5908254829574	230V~, 50Hz	8 x E27	8 x 60W	Stal Steel	Biały White	750 / 50 / 25
AD-OP-6435WE27	5908254829598	230V~, 50Hz	10 x E27	10 x 60W	Stal Steel	Biały White	950 / 50 / 25



AD-OP-6429BE27



AD-OP-6430BE27



AD-OP-6431BE27



AD-OP-6436BE27



AD-OP-6432BE27



AD-OP-6433BE27



AD-OP-6434BE27



AD-OP-6435BE27

Symbol Product no.	EAN	Napięcie nominalne Nominal voltage	Źródło światła Light source	Moc Power	Materiał lampy Lamp material	Kolor obudowy Housing color	Wymiary (szer./wys./gł) [mm] Dimensions (W/H/D) [mm]
AD-OP-6429BE27	5908254829468	230V~, 50Hz	1 x E27	1 x 60W	Stal Steel	Czarny Black	165 / 50 / 25
AD-OP-6430BE27	5908254829482	230V~, 50Hz	2 x E27	2 x 60W	Stal Steel	Czarny Black	300 / 50 / 25
AD-OP-6436BE27	5908254829604	230V~, 50Hz	3 x E27	3 x 60W	Stal Steel	Czarny Black	Ø 190 / 25
AD-OP-6431BE27	5908254829505	230V~, 50Hz	3 x E27	3 x 60W	Stal Steel	Czarny Black	480 / 50 / 25
AD-OP-6432BE27	5908254829529	230V~, 50Hz	4 x E27	4 x 60W	Stal Steel	Czarny Black	630 / 50 / 25
AD-OP-6433BE27	5908254829543	230V~, 50Hz	6 x E27	6 x 60W	Stal Steel	Czarny Black	630 / 50 / 25
AD-OP-6434BE27	5908254829567	230V~, 50Hz	8 x E27	8 x 60W	Stal Steel	Czarny Black	750 / 50 / 25
AD-OP-6435BE27	5908254829581	230V~, 50Hz	10 x E27	10 x 60W	Stal Steel	Czarny Black	950 / 50 / 25

Pino

Oprawy ściennie-sufitowe
Wall and ceiling lights



AD-LD-6366BE27M



AD-LD-6367BE27M



AD-LD-6368BE27M



AD-LD-6369BE27M



AD-LD-6370BE27M



AD-LD-6371BE27M



AD-LD-6372BE27M

Solin

Oprawy ściennie-sufitowe
Wall and ceiling lights



AD-LD-6382BE27D



AD-LD-6383BE27D



AD-LD-6384BE27D



Źródło światła: E27
 Light source: E27



Materiał lampy: Metal
 Lamp material: Metal



Symbol Product no.	EAN	Napięcie nominalne Nominal voltage	Źródło światła Light source	Moc Power	Materiał klosza Lampshade material	Wymiary (szer./wys./gł) [mm] Dimensions (W/H/D) [mm]
AD-LD-6366BE27M	5904988905645	230V~, 50Hz	1 x E27	1 x 60W	Metal	Ø 100 / 250
AD-LD-6367BE27M	5904988905652	230V~, 50Hz	2 x E27	2 x 60W	Metal	210 / 180 / 400
AD-LD-6368BE27M	5904988905669	230V~, 50Hz	2 x E27	2 x 60W	Metal	200 / 200 / 210
AD-LD-6369BE27M	5904988905676	230V~, 50Hz	3 x E27	3 x 60W	Metal	180 / 210 / 600
AD-LD-6370BE27M	5904988905683	230V~, 50Hz	3 x E27	3 x 60W	Metal	300 / 190 / 450
AD-LD-6371BE27M	5904988905690	230V~, 50Hz	3 x E27	3 x 60W	Metal	Ø 290 / 380
AD-LD-6372BE27M	5904988905706	230V~, 50Hz	3 x E27	3 x 60W	Metal	460 / 200 / 300
AD-LD-6382BE27D	5904988905805	230V~, 50Hz	1 x E27	1 x 60W	Drewno Wood	295 / 160 / 200
AD-LD-6383BE27D	5904988905812	230V~, 50Hz	2 x E27	2 x 60W	Drewno Wood	180 / 210 / 400
AD-LD-6384BE27D	5904988905829	230V~, 50Hz	3 x E27	3 x 60W	Drewno Wood	180 / 210 / 600

Isla

Oprawy ścienna-sufitowe
Wall and ceiling lights



AD-LD-6385BE27M



AD-LD-6386BE27M



AD-LD-6387BE27M



AD-LD-6388BE27M



AD-LD-6389BE27M



AD-LD-6390BE27M



AD-LD-6391BE27M

Lisa

Oprawy ścienna-sufitowe
Wall and ceiling lights



AD-LD-6392BE27M



AD-LD-6393BE27M



AD-LD-6394BE27M



AD-LD-6395BE27M



AD-LD-6396BE27M



AD-LD-6397BE27M



AD-LD-6398BE27M



Symbol Product no.	EAN	Napięcie nominalne Nominal voltage	Źródło światła Light source	Moc Power	Materiał lampy Lamp material	Kolor obudowy Housing color	Wymiary (szer./wys./gł) [mm] Dimensions (W/H/D) [mm]
AD-LD-6385BE27M	5904988905836	230V~, 50Hz	1 x E27	1 x 60W	Metal	Czarny Black	Ø 125 / 160
AD-LD-6386BE27M	5904988905843	230V~, 50Hz	2 x E27	2 x 60W	Metal	Czarny Black	400 / 125 / 160
AD-LD-6387BE27M	5904988905850	230V~, 50Hz	2 x E27	2 x 60W	Metal	Czarny Black	200 / 200 / 160
AD-LD-6388BE27M	5904988905867	230V~, 50Hz	3 x E27	3 x 60W	Metal	Czarny Black	600 / 125 / 160
AD-LD-6389BE27M	5904988905874	230V~, 50Hz	3 x E27	3 x 60W	Metal	Czarny Black	Ø 300 / 160
AD-LD-6390BE27M	5904988905881	230V~, 50Hz	3 x E27	3 x 60W	Metal	Czarny Black	Ø 300 / 280
AD-LD-6391BE27M	5904988905898	230V~, 50Hz	3 x E27	3 x 60W	Metal	Czarny Black	Ø 300 / 280
AD-LD-6392BE27M	5904988905904	230V~, 50Hz	1 x E27	1 x 60W	Metal	Czarny Black	Ø 115 / 150
AD-LD-6393BE27M	5904988905911	230V~, 50Hz	2 x E27	2 x 60W	Metal	Czarny Black	400 / 115 / 150
AD-LD-6394BE27M	5904988905928	230V~, 50Hz	2 x E27	2 x 60W	Metal	Czarny Black	200 / 200 / 150
AD-LD-6395BE27M	5904988905935	230V~, 50Hz	3 x E27	3 x 60W	Metal	Czarny Black	600 / 115 / 150
AD-LD-6396BE27M	5904988905942	230V~, 50Hz	3 x E27	3 x 60W	Metal	Czarny Black	Ø 300 / 150
AD-LD-6397BE27M	5904988905959	230V~, 50Hz	3 x E27	3 x 60W	Metal	Czarny Black	Ø 300 / 270
AD-LD-6398BE27M	5904988905966	230V~, 50Hz	3 x E27	3 x 60W	Metal	Czarny Black	Ø 300 / 270

Delos

Oprawy ścienna-sufitowe
Wall and ceiling lights

Adviti
LIGHTING SOLUTIONS

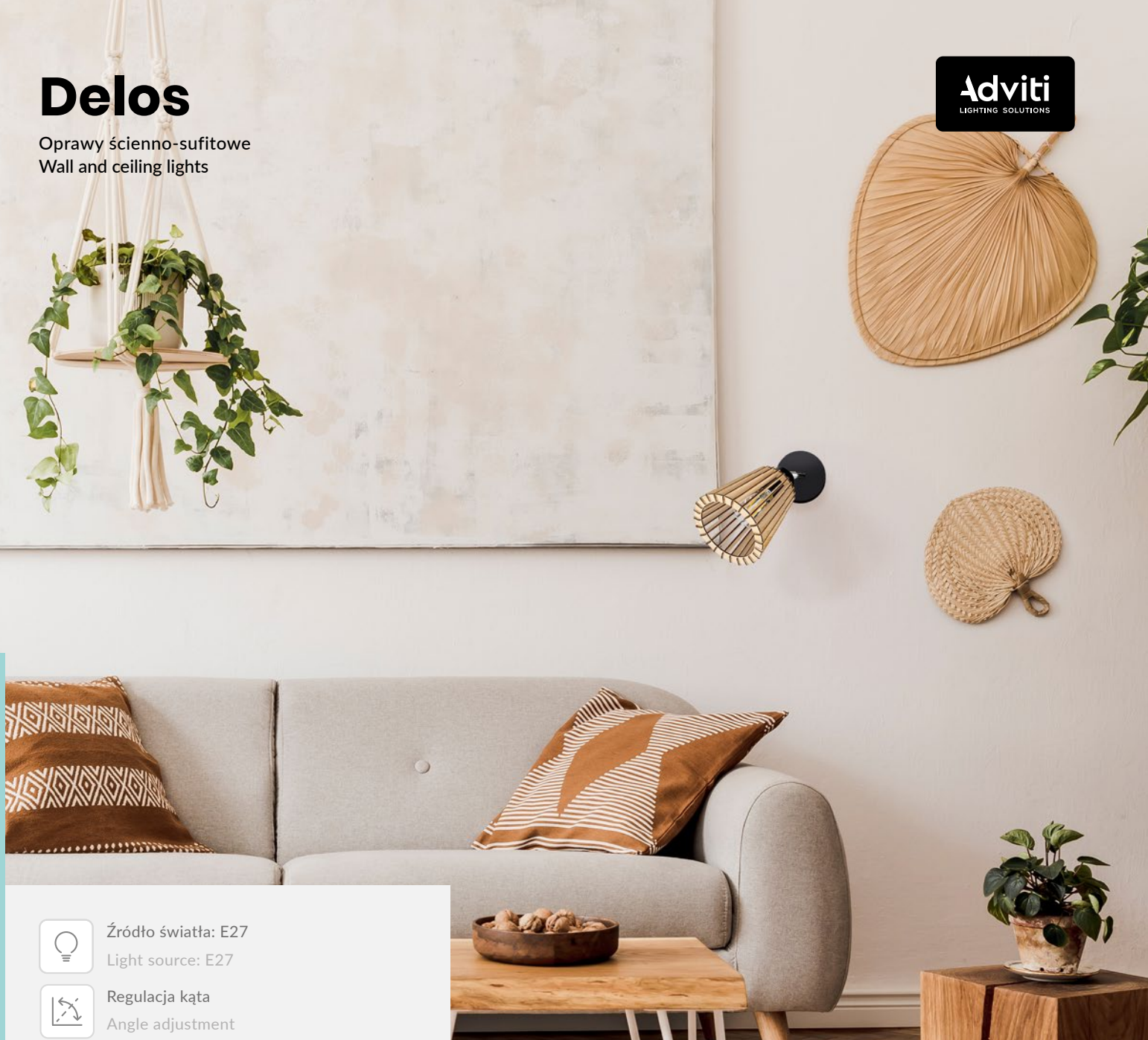

Źródło światła: E27
Light source: E27



Regulacja kąta
Angle adjustment



AD-LD-6404BE27D



AD-LD-6405BE27D



AD-LD-6406BE27D

Symbol Product no.	EAN	Napięcie nominalne Nominal voltage	Źródło światła Light source	Moc Power	Materiał klosza Lampshade material	Kolor obudowy Housing color	Wymiary (szer./wys./gł) [mm] Dimensions (W/H/D) [mm]
AD-LD-6404BE27D	5904988906680	230V~, 50Hz	1 x E27	1 x 60W	Drewno Wood	Czarny Black	Ø 150 / 225
AD-LD-6405BE27D	5904988906697	230V~, 50Hz	2 x E27	2 x 60W	Drewno Wood	Czarny Black	400 / 150 / 225
AD-LD-6406BE27D	5904988906703	230V~, 50Hz	3 x E27	3 x 60W	Drewno Wood	Czarny Black	600 / 150 / 225

Siena

Oprawy ścienna-sufitowe
Wall and ceiling lights

Adviti
LIGHTING SOLUTIONS



Źródło światła: E27
Light source: E27



Regulacja kąta
Angle adjustment



AD-LD-6418BE27SW



AD-LD-6420BE27SW



AD-LD-6419BE27SW



AD-LD-6421BE27SW



AD-LD-6422BE27SW



AD-LD-6423BE27SW



AD-LD-6424BE27SW

Symbol Product no.	EAN	Napięcie nominalne Nominal voltage	Źródło światła Light source	Moc Power	Materiał klosza Lampshade material	Kolor obudowy Housing color	Wymiary (szer./wys./gł) [mm] Dimensions (W/H/D) [mm]
AD-LD-6418BE27SW	5904988906826	230V~, 50Hz	1 x E27	1 x 60W	Szkoło Glass	Czarny Black	100 / 190 / 100
AD-LD-6419BE27SW	5904988906833	230V~, 50Hz	2 x E27	2 x 60W	Szkoło Glass	Czarny Black	400 / 100 / 190
AD-LD-6420BE27SW	5904988906840	230V~, 50Hz	2 x E27	2 x 60W	Szkoło Glass	Czarny Black	200 / 200 / 190
AD-LD-6421BE27SW	5904988906857	230V~, 50Hz	3 x E27	3 x 60W	Szkoło Glass	Czarny Black	600 / 100 / 190
AD-LD-6422BE27SW	5904988906864	230V~, 50Hz	3 x E27	3 x 60W	Szkoło Glass	Czarny Black	∅ 300 / 190
AD-LD-6423BE27SW	5904988906871	230V~, 50Hz	3 x E27	3 x 60W	Szkoło Glass	Czarny Black	∅ 300 / 310
AD-LD-6424BE27SW	5904988906888	230V~, 50Hz	3 x E27	3 x 60W	Szkoło Glass	Czarny Black	∅ 300 / 310

Rollo

Kinkiety
Wall lamps

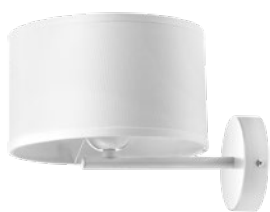

AD-LD-6341WE27T



AD-LD-6341GE27T



AD-LD-6341BE27T



AD-LD-6341YE27T



AD-LD-6341GNE27T

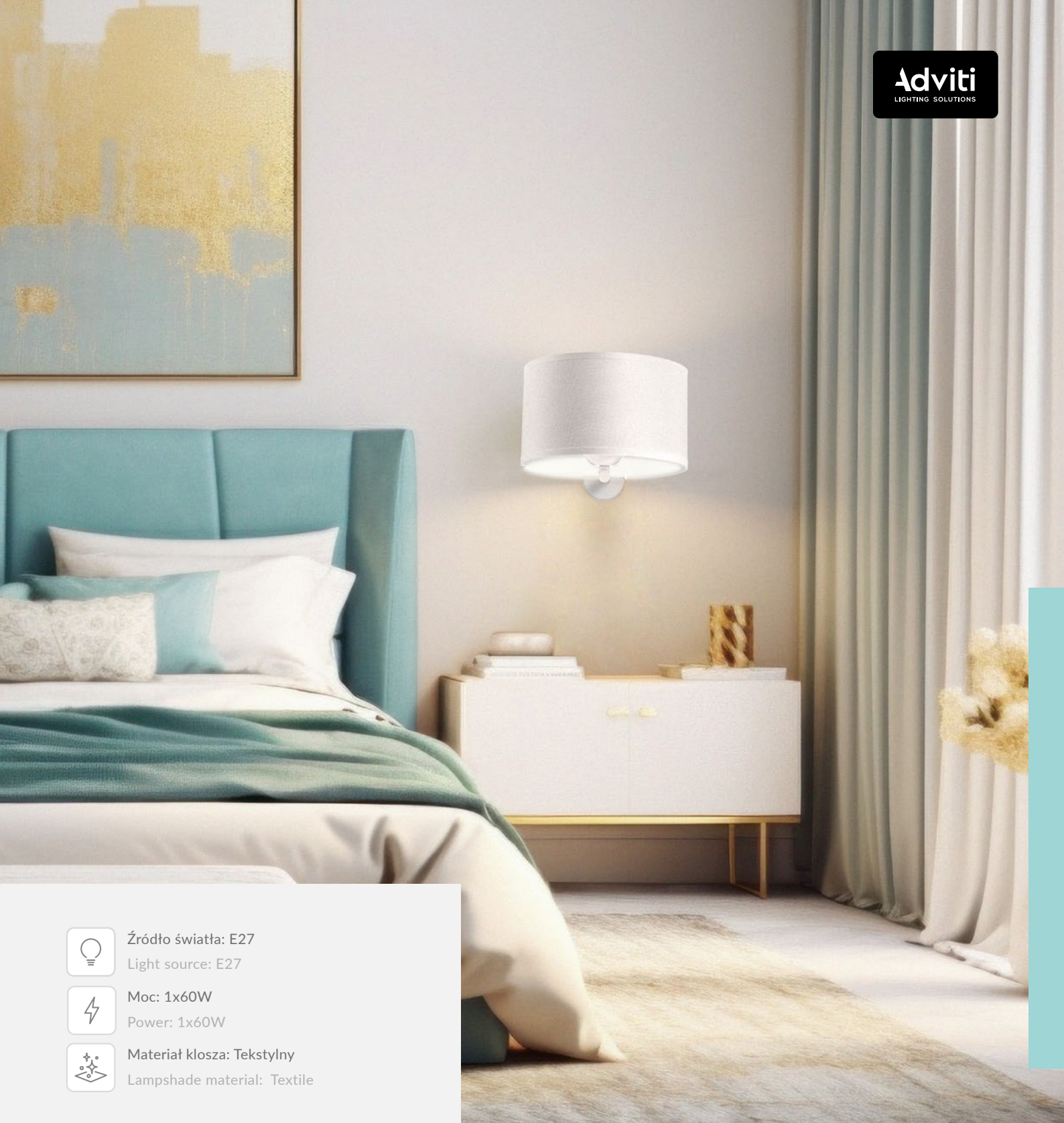

Źródło światła: E27
 Light source: E27



Moc: 1x60W
 Power: 1x60W



Materiał klosza: Tekstylny
 Lampshade material: Textile

Symbol Product no.	EAN	Napięcie nominalne Nominal voltage	Źródło światła Light source	Moc Power	Materiał klosza Lampshade material	Kolor klosza Lampshade color	Wymiary (szer./wys./gł) [mm] Dimensions (W/H/D) [mm]
AD-LD-6341WE27T	5904988904822	230V~, 50Hz	1 x E27	1 x 60W	Tekstylny Textile	Biały White	Ø 170 / 200
AD-LD-6341GE27T	5904988904839	230V~, 50Hz	1 x E27	1 x 60W	Tekstylny Textile	Szary Grey	Ø 170 / 200
AD-LD-6341GNE27T	5904988904846	230V~, 50Hz	1 x E27	1 x 60W	Tekstylny Textile	Butelkowa zieleń Bottle green	Ø 170 / 200
AD-LD-6341BE27T	5904988904853	230V~, 50Hz	1 x E27	1 x 60W	Tekstylny Textile	Czarny Black	Ø 170 / 200
AD-LD-6341YE27T	5904988904877	230V~, 50Hz	1 x E27	1 x 60W	Tekstylny Textile	Musztardowy Yellow	Ø 170 / 200

Lampy wiszące

Pendant lights

Adviti
LIGHTING SOLUTIONS



Waya

Oprawy wiszące
Pendant lamps



AD-LD-6263BE27M



AD-LD-6345WE27M

Kinkiety
Wall lamps



AD-LD-6259BE27M



AD-LD-6260WE27M



AD-LD-6261BE27M



AD-LD-6264BE27M

Symbol Product no.	EAN	Napięcie nominalne Nominal voltage	Źródło światła Light source	Moc Power	Materiał lampy Lamp material	Kolor obudowy Housing color	Wymiary (szer./wys./gt) [mm] Dimensions (W/H/D) [mm]
AD-LD-6259BE27M	5904988901487	230V~, 50Hz	1 x E27	1 x 60W	Metal	Czarny Black	350 / 220 / 240
AD-LD-6260WE27M	5904988901494	230V~, 50Hz	1 x E27	1 x 60W	Metal	Biały White	180 / 240 / 200
AD-LD-6261BE27M	5904988901500	230V~, 50Hz	1 x E27	1 x 60W	Metal	Czarny Black	180 / 220 / 180
AD-LD-6263BE27M	5904988901524	230V~, 50Hz	1 x E27	1 x 60W	Metal	Czarny Black	180 / 750 / 180
AD-LD-6345WE27M	5904988905225	230V~, 50Hz	1 x E27	1 x 60W	Metal	Biały White	180 / 800 / 180
AD-LD-6264BE27M	5904988901531	230V~, 50Hz	3 x E27	3 x 60W	Metal	Czarny Black	400 / 700 / 400

Marbella

Oprawy wiszące
Pendant lamps



AD-LD-6351BE27M



AD-LD-6352BE27M



AD-LD-6353BE27M



Kinkiet
Wall lamp



AD-LD-6350BE27M

Symbol Product no.	EAN	Napięcie nominalne Nominal voltage	Źródło światła Light source	Moc Power	Materiał lampy Lamp material	Kolor obudowy Housing color	Wymiary (szer./wys./gł) [mm] Dimensions (W/H/D) [mm]
AD-LD-6350BE27M	5904988905492	230V~, 50Hz	1 x E27	1 x 60W	Metal	Czarny Black	160 / 250 / 340
AD-LD-6351BE27M	5904988905508	230V~, 50Hz	3 x E27	3 x 60W	Metal	Czarny Black	680 / 540 / 680
AD-LD-6352BE27M	5904988905515	230V~, 50Hz	4 x E27	4 x 60W	Metal	Czarny Black	650 / 450 / 650
AD-LD-6353BE27M	5904988905522	230V~, 50Hz	5 x E27	5 x 60W	Metal	Czarny Black	710 / 380 / 710

Vigo

Oprawy wiszące
Pendant lamps



AD-LD-6355BE27T



AD-LD-6356BE27T



AD-LD-6357BE27T



AD-LD-6354BE27T

Kinkiet
Wall lamp

Milano

Oprawy wiszące
Pendant lamps



AD-LD-6415BE27SW



AD-LD-6416BE27SW



AD-LD-6417BE27SW



AD-LD-6414BE27SW

Kinkiet
Wall lamp

Symbol Product no.	EAN	Napięcie nominalne Nominal voltage	Źródło światła Light source	Moc Power	Materiał klosza Lampshade material	Kolor obudowy Housing color	Wymiary (szer./wys./gł) [mm] Dimensions (W/H/D) [mm]
AD-LD-6354BE27T	5904988905539	230V~, 50Hz	1 x E27	1 x 60W	Tekstylny Textile	Czarny Black	160 / 340 / 250
AD-LD-6355BE27T	5904988905546	230V~, 50Hz	3 x E27	3 x 60W	Tekstylny Textile	Czarny Black	690 / 690 / 410
AD-LD-6356BE27T	5904988905553	230V~, 50Hz	4 x E27	4 x 60W	Tekstylny Textile	Czarny Black	680 / 680 / 400
AD-LD-6357BE27T	5904988905560	230V~, 50Hz	5 x E27	5 x 60W	Tekstylny Textile	Czarny Black	700 / 700 / 400

Symbol Product no.	EAN	Napięcie nominalne Nominal voltage	Źródło światła Light source	Moc Power	Materiał klosza Lampshade material	Kolor obudowy Housing color	Wymiary (szer./wys./gł) [mm] Dimensions (W/H/D) [mm]
AD-LD-6414BE27SW	5904988906789	230V~, 50Hz	1 x E27	1 x 60W	Szkoło Glass	Czarny Black	160 / 640 / 250
AD-LD-6415BE27SW	5904988906796	230V~, 50Hz	3 x E27	3 x 60W	Szkoło Glass	Czarny Black	680 / 680 / 410
AD-LD-6416BE27SW	5904988906802	230V~, 50Hz	4 x E27	4 x 60W	Szkoło Glass	Czarny Black	650 / 650 / 450
AD-LD-6417BE27SW	5904988906819	230V~, 50Hz	5 x E27	5 x 60W	Szkoło Glass	Czarny Black	710 / 710 / 380

Anafi

Oprawy wiszące
Pendant lamps



AD-LD-6411BE27D



AD-LD-6412BE27D



AD-LD-6413BE27D

Symbol Product no.	EAN	Napięcie nominalne Nominal voltage	Źródło światła Light source	Moc Power	Materiał klosza Lampshade material	Kolor obudowy Housing color	Wymiary (szer./wys./gł) [mm] Dimensions (W/H/D) [mm]
AD-LD-6411BE27D	5904988906758	230V~, 50Hz	1 x E27	1 x 60W	Drewno Wood	Czarny Black	Ø 220 / 770
AD-LD-6412BE27D	5904988906765	230V~, 50Hz	2 x E27	2 x 60W	Drewno Wood	Czarny Black	400 / 570 / 220
AD-LD-6413BE27D	5904988906772	230V~, 50Hz	3 x E27	3 x 60W	Drewno Wood	Czarny Black	770 / 600 / 220

Lino

Oprawy wiszące
Pendant lamps



AD-LD-6358BE27



AD-LD-6359BE27



AD-LD-6360BE27

Symbol Product no.	EAN	Napięcie nominalne Nominal voltage	Źródło światła Light source	Moc Power	Materiał lampy Lamp material	Kolor obudowy Housing color	Wymiary (szer./wys./gł) [mm] Dimensions (W/H/D) [mm]
AD-LD-6358BE27	5904988905577	230V~, 50Hz	1 x E27	1 x 60W	Metal	Czarny Black	95 / 1500 / 95
AD-LD-6359BE27	5904988905584	230V~, 50Hz	3 x E27	3 x 60W	Metal	Czarny Black	95 / 1500 / 95
AD-LD-6360BE27	5904988905591	230V~, 50Hz	5 x E27	5 x 60W	Metal	Czarny Black	95 / 1500 / 95

Neva

Oprawy wiszące
Pendant lamps



AD-LD-6361BE27T



AD-LD-6362BE27T



AD-LD-6364BE27T



AD-LD-6365BE27T



Symbol Product no.	EAN	Napięcie nominalne Nominal voltage	Źródło światła Light source	Moc Power	Materiał klosza Lampshade material	Kolor obudowy Housing color	Wymiary (szer./wys./gł) [mm] Dimensions (W/H/D) [mm]
AD-LD-6361BE27T	5904988905607	230V~, 50Hz	1 x E27	1 x 60W	Tekstylny Textile	Czarny Black	Ø 150 / 740
AD-LD-6362BE27T	5904988905614	230V~, 50Hz	2 x E27	2 x 60W	Tekstylny Textile	Czarny Black	400 / 740 / 150
AD-LD-6364BE27T	5904988905621	230V~, 50Hz	3 x E27	3 x 60W	Tekstylny Textile	Czarny Black	600 / 740 / 150
AD-LD-6365BE27T	5904988905638	230V~, 50Hz	3 x E27	3 x 60W	Tekstylny Textile	Czarny Black	Ø 300 / 890

Pino

Oprawy wiszące
Pendant lamps



AD-LD-6373BE27M



AD-LD-6374BE27M



AD-LD-6375BE27M



AD-LD-6376BE27M

Symbol Product no.	EAN	Napięcie nominalne Nominal voltage	Źródło światła Light source	Moc Power	Materiał lampy Lamp material	Kolor obudowy Housing color	Wymiary (szer./wys./gł) [mm] Dimensions (W/H/D) [mm]
AD-LD-6373BE27M	5904988905713	230V~, 50Hz	1 x E27	1 x 60W	Metal	Czarny Black	Ø 180 / 730
AD-LD-6374BE27M	5904988905720	230V~, 50Hz	2 x E27	2 x 60W	Metal	Czarny Black	400 / 730 / 180
AD-LD-6375BE27M	5904988905737	230V~, 50Hz	3 x E27	3 x 60W	Metal	Czarny Black	600 / 730 / 180
AD-LD-6376BE27M	5904988905744	230V~, 50Hz	3 x E27	3 x 60W	Metal	Czarny Black	Ø 300 / 880



Delos

Oprawy wiszące
Pendant lamps



AD-LD-6407BE27D



AD-LD-6408BE27D



AD-LD-6409BE27D



AD-LD-6410BE27D

Symbol Product no.	EAN	Napięcie nominalne Nominal voltage	Źródło światła Light source	Moc Power	Materiał klosza Lampshade material	Kolor obudowy Housing color	Wymiary (szer./wys./gł) [mm] Dimensions (W/H/D) [mm]
AD-LD-6407BE27D	5904988906710	230V~, 50Hz	1 x E27	1 x 60W	Drewno Wood	Czarny Black	Ø 150 / 760
AD-LD-6408BE27D	5904988906727	230V~, 50Hz	2 x E27	2 x 60W	Drewno Wood	Czarny Black	400 / 560 / 150
AD-LD-6409BE27D	5904988906734	230V~, 50Hz	3 x E27	3 x 60W	Drewno Wood	Czarny Black	600 / 760 / 150
AD-LD-6410BE27D	5904988906741	230V~, 50Hz	3 x E27	3 x 60W	Drewno Wood	Czarny Black	Ø 300 / 910

Malaga

Oprawy wiszące
Pendant lamps

Kinkiet
Wall lamp



AD-LD-6400BE27M



AD-LD-6401BE27M



AD-LD-6402BE27M



AD-LD-6403BE27M



AD-LD-6399BE27M

Symbol Product no.	EAN	Napięcie nominalne Nominal voltage	Źródło światła Light source	Moc Power	Materiał lampy Lamp material	Kolor obudowy Housing color	Wymiary (szer./wys./gł) [mm] Dimensions (W/H/D) [mm]
AD-LD-6399BE27M	5904988905973	230V~, 50Hz	1 x E27	1 x 60W	Metal	Czarny Black	100 / 310 / 270
AD-LD-6400BE27M	5904988905980	230V~, 50Hz	2 x E27	2 x 60W	Metal	Czarny Black	100 / 400 / 200
AD-LD-6401BE27M	5904988905997	230V~, 50Hz	3 x E27	3 x 60W	Metal	Czarny Black	270 / 270 / 260
AD-LD-6402BE27M	5904988906000	230V~, 50Hz	4 x E27	4 x 60W	Metal	Czarny Black	450 / 450 / 300
AD-LD-6403BE27M	5904988906017	230V~, 50Hz	5 x E27	5 x 60W	Metal	Czarny Black	450 / 450 / 420



Oprawy wiszące

Pendant lamps

Juala



AD-LD-6377BE27D



AD-LD-6378BE27D

Yasin



AD-LD-6380BE27D

Palla



AD-LD-6381BE27D

Cubo



AD-LD-6379BE27M



Symbol Product no.	EAN	Napięcie nominalne Nominal voltage	Źródło światła Light source	Moc Power	Materiał klosza Lampshade material	Kolor obudowy Housing color	Wymiary (szer./wys./gł) [mm] Dimensions (W/H/D) [mm]
AD-LD-6377BE27D	5904988905751	230V~, 50Hz	2 x E27	2 x 60W	Drewno Wood	Czarny Black	400 / 610 / 240
AD-LD-6378BE27D	5904988905768	230V~, 50Hz	3 x E27	3 x 60W	Drewno Wood	Czarny Black	600 / 810 / 240
AD-LD-6379BE27M	5904988905775	230V~, 50Hz	1 x E27	1 x 60W	Metal	Czarny Black	Ø 180 / 790
AD-LD-6380BE27D	5904988905782	230V~, 50Hz	1 x E27	1 x 60W	Drewno Wood	Czarny Black	Ø 400 / 1160
AD-LD-6381BE27D	5904988905799	230V~, 50Hz	1 x E27	1 x 60W	Drewno Wood	Czarny Black	Ø 260 / 830

Leia

Oprawy wiszące
Pendant lamps

Adviti
LIGHTING SOLUTIONS



AD-LD-6438B-CE27SM



AD-LD-6438BE27SM



AD-LD-6438CE27SM



AD-LD-6438W-CE27SM



AD-LD-6438GGE27SM

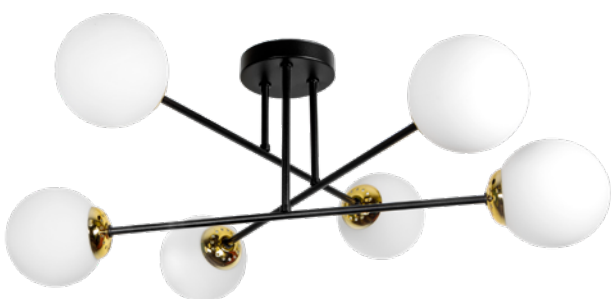

AD-LD-6439B-CE27SM

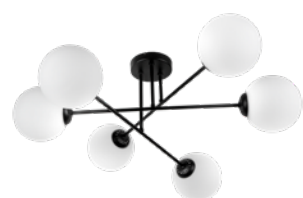

AD-LD-6439BE27SM

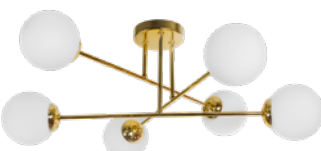

AD-LD-6439CE27SM

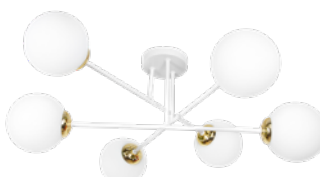

AD-LD-6439W-CE27SM

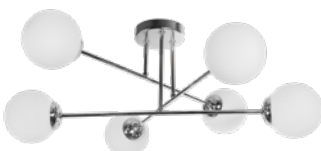

AD-LD-6439GGE27SM

Symbol Product no.	EAN	Napięcie nominalne Nominal voltage	Źródło światła Light source	Moc Power	Materiał klosza Lampshade material	Kolor obudowy Housing color	Wymiary (szer./wys./gł) [mm] Dimensions (W/H/D) [mm]
AD-LD-6438B-CE27SM	5904988907014	230V~, 50Hz	4 x E27	4 x 60W	Szkło mleczne Milky glass	Czarny / złoty Black / gold	770 / 220 / 770
AD-LD-6438BE27SM	5904988907021	230V~, 50Hz	4 x E27	4 x 60W	Szkło mleczne Milky glass	Czarny Black	770 / 220 / 770
AD-LD-6438CE27SM	5904988907038	230V~, 50Hz	4 x E27	4 x 60W	Szkło mleczne Milky glass	Złoty Gold	770 / 220 / 770
AD-LD-6438W-CE27SM	5904988907045	230V~, 50Hz	4 x E27	4 x 60W	Szkło mleczne Milky glass	Biały / złoty White / gold	770 / 220 / 770
AD-LD-6438GGE27SM	5904988907052	230V~, 50Hz	4 x E27	4 x 60W	Szkło mleczne Milky glass	Chrom Chrome	770 / 220 / 770
AD-LD-6439B-CE27SM	5904988907069	230V~, 50Hz	6 x E27	6 x 60W	Szkło mleczne Milky glass	Czarny / złoty Black / gold	770 / 320 / 770
AD-LD-6439BE27SM	5904988907076	230V~, 50Hz	6 x E27	6 x 60W	Szkło mleczne Milky glass	Czarny Black	770 / 320 / 770
AD-LD-6439CE27SM	5904988907083	230V~, 50Hz	6 x E27	6 x 60W	Szkło mleczne Milky glass	Złoty Gold	770 / 320 / 770
AD-LD-6439W-CE27SM	5904988907090	230V~, 50Hz	6 x E27	6 x 60W	Szkło mleczne Milky glass	Biały / złoty White / gold	770 / 320 / 770
AD-LD-6439GGE27SM	5904988907106	230V~, 50Hz	6 x E27	6 x 60W	Szkło mleczne Milky glass	Chrom Chrome	770 / 320 / 770

Solo

Oprawy wiszące
Pendant lamps



AD-LD-6440BE27



AD-LD-6441BE27



AD-LD-6441CE27



AD-LD-6441GGE27

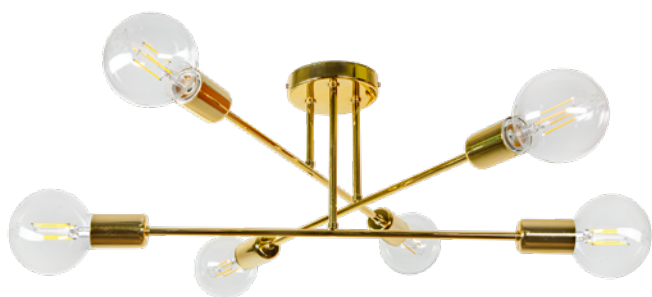

AD-LD-6442CE27



AD-LD-6442BE27



AD-LD-6442GGE27

Symbol Product no.	EAN	Napięcie nominalne Nominal voltage	Źródło światła Light source	Moc Power	Materiał lampy Lamp material	Kolor obudowy Housing color	Wymiary (szer./wys./gł) [mm] Dimensions (W/H/D) [mm]
AD-LD-6440BE27	5904988907113	230V~, 50Hz	2 x E27	2 x 60W	Metal	Czarny Black	600 / 140 / 600
AD-LD-6441BE27	5904988907120	230V~, 50Hz	4 x E27	4 x 60W	Metal	Czarny Black	600 / 210 / 600
AD-LD-6441CE27	5904988907137	230V~, 50Hz	4 x E27	4 x 60W	Metal	Złoty Gold	600 / 210 / 600
AD-LD-6441GGE27	5904988907144	230V~, 50Hz	4 x E27	4 x 60W	Metal	Chrom Chrome	600 / 210 / 600
AD-LD-6442BE27	5904988907151	230V~, 50Hz	6 x E27	6 x 60W	Metal	Czarny Black	600 / 270 / 600
AD-LD-6442CE27	5904988907168	230V~, 50Hz	6 x E27	6 x 60W	Metal	Złoty Gold	600 / 270 / 600
AD-LD-6442GGE27	5904988907175	230V~, 50Hz	6 x E27	6 x 60W	Metal	Chrom Chrome	600 / 270 / 600

Kylo

Oprawy wiszące
Pendant lamps



AD-LD-6443BE27T



AD-LD-6444BE27T



AD-LD-6445BE27T



AD-LD-6448BE27T



AD-LD-6446BE27T



AD-LD-6447BE27T



AD-LD-6449BE27T



AD-LD-6450BE27T



AD-LD-6452BE27T



AD-LD-6451BE27T

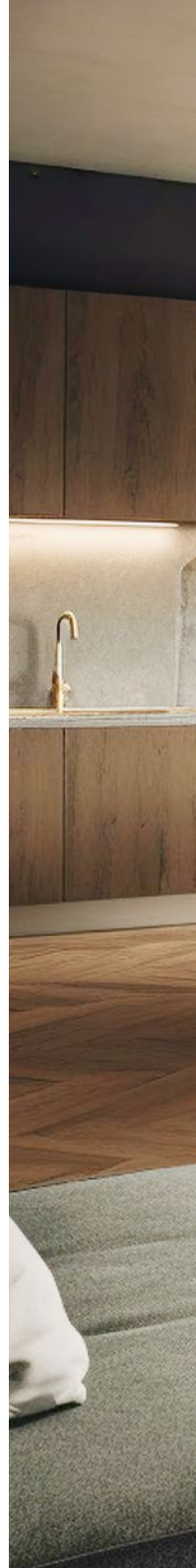



Symbol Product no.	EAN	Napięcie nominalne Nominal voltage	Źródło światła Light source	Moc Power	Materiał klosza Lampshade material	Kolor obudowy Housing color	Wymiary (szer./wys./gł) [mm] Dimensions (W/H/D) [mm]
AD-LD-6443BE27T	5904988907182	230V~, 50Hz	1 x E27	1 x 60W	Tekstylny / tworzywo sztuczne Textile / plastic	Czarny Black	Ø 200 / 1000
AD-LD-6444BE27T	5904988907199	230V~, 50Hz	1 x E27	1 x 60W	Tekstylny / tworzywo sztuczne Textile / plastic	Czarny Black	Ø 400 / 1000
AD-LD-6445BE27T	5904988907205	230V~, 50Hz	1 x E27	1 x 60W	Tekstylny / tworzywo sztuczne Textile / plastic	Czarny Black	Ø 450 / 1000
AD-LD-6446BE27T	5904988907212	230V~, 50Hz	2 x E27	2 x 60W	Tekstylny / tworzywo sztuczne Textile / plastic	Czarny Black	400 / 1000 / 200
AD-LD-6447BE27T	5904988907229	230V~, 50Hz	3 x E27	3 x 60W	Tekstylny / tworzywo sztuczne Textile / plastic	Czarny Black	600 / 1000 / 200
AD-LD-6448BE27T	5904988907236	230V~, 50Hz	3 x E27	3 x 60W	Tekstylny / tworzywo sztuczne Textile / plastic	Czarny Black	Ø 300 / 1000
AD-LD-6449BE27T	5904988907243	230V~, 50Hz	2 x E27	2 x 60W	Tekstylny / tworzywo sztuczne Textile / plastic	Czarny Black	Ø 200 / 2200
AD-LD-6450BE27T	5904988907250	230V~, 50Hz	3 x E27	3 x 60W	Tekstylny / tworzywo sztuczne Textile / plastic	Czarny Black	Ø 200 / 2200
AD-LD-6451BE27T	5904988907267	230V~, 50Hz	4 x E27	4 x 60W	Tekstylny / tworzywo sztuczne Textile / plastic	Czarny Black	Ø 200 / 2200
AD-LD-6452BE27T	5904988907274	230V~, 50Hz	5 x E27	5 x 60W	Tekstylny / tworzywo sztuczne Textile / plastic	Czarny Black	Ø 200 / 2200

Rollo

Oprawy wiszące
Pendant lamps



AD-LD-6340WE27T

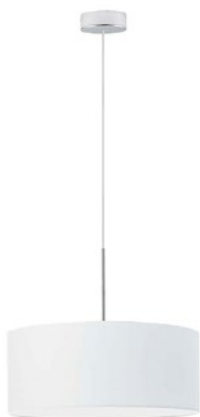

AD-LD-6339WE27T



AD-LD-6340GE27T



AD-LD-6339GE27T



AD-LD-6340GNE27T



AD-LD-6339GNE27T



AD-LD-6340BE27T



AD-LD-6339BE27T



AD-LD-6340YE27T



AD-LD-6339YE27T





Symbol Product no.	EAN	Napięcie nominalne Nominal voltage	Źródło światła Light source	Moc Power	Materiał klosza Lampshade material	Kolor klosza Lampshade color	Średnica/wys. [mm] Diameter/H [mm]
AD-LD-6339WE27T	5904988904709	230V~, 50Hz	1 x E27	1 x 60W	Tekstylny Textile	Biały White	Ø 400 / 1200
AD-LD-6339GE27T	5904988904716	230V~, 50Hz	1 x E27	1 x 60W	Tekstylny Textile	Szary Grey	Ø 400 / 1200
AD-LD-6339GNE27T	5904988904723	230V~, 50Hz	1 x E27	1 x 60W	Tekstylny Textile	Butelkowa zieleń Bottle green	Ø 400 / 1200
AD-LD-6339BE27T	5904988904730	230V~, 50Hz	1 x E27	1 x 60W	Tekstylny Textile	Czarny Black	Ø 400 / 1200
AD-LD-6339YE27T	5904988904754	230V~, 50Hz	1 x E27	1 x 60W	Tekstylny Textile	Musztardowy Yellow	Ø 400 / 1200
AD-LD-6340WE27T	5904988904761	230V~, 50Hz	1 x E27	1 x 60W	Tekstylny Textile	Biały White	Ø 400 / 300
AD-LD-6340GE27T	5904988904778	230V~, 50Hz	1 x E27	1 x 60W	Tekstylny Textile	Szary Grey	Ø 400 / 300
AD-LD-6340GNE27T	5904988904785	230V~, 50Hz	1 x E27	1 x 60W	Tekstylny Textile	Butelkowa zieleń Bottle green	Ø 400 / 300
AD-LD-6340BE27T	5904988904792	230V~, 50Hz	1 x E27	1 x 60W	Tekstylny Textile	Czarny Black	Ø 400 / 300
AD-LD-6340YE27T	5904988904815	230V~, 50Hz	1 x E27	1 x 60W	Tekstylny Textile	Musztardowy Yellow	Ø 400 / 300

Lampy stojące

Floor lamps



Kylo

Lampy stojące
Floor lamps



AD-LD-6453BE27T



AD-LD-6454BE27T



AD-LD-6455BE27T

Rollo

Lampa stojąca
Floor lamp



AD-LD-6343WE27T

Symbol Product no.	EAN	Napięcie nominalne Nominal voltage	Źródło światła Light source	Moc Power	Materiał klosza Lampshade material	Kolor obudowy Housing color	Średnica/wys. [mm] Diameter/H [mm]
AD-LD-6453BE27T	5904988907281	230V~, 50Hz	1 x E27	1 x 60W	Tekstylny / tworzywo sztuczne Textile / plastic	Czarny Black	Ø 450 / 1500
AD-LD-6454BE27T	5904988907298	230V~, 50Hz	1 x E27	1 x 60W	Tekstylny / tworzywo sztuczne Textile / plastic	Czarny Black	Ø 450 / 1400
AD-LD-6455BE27T	5904988907304	230V~, 50Hz	1 x E27	1 x 60W	Tekstylny / tworzywo sztuczne Textile / plastic	Czarny Black	Ø 450 / 1650
AD-LD-6343WE27T	5904988904921	230V~, 50Hz	1 x E27	1 x 60W	Tekstylny Textile	Biały White	Ø 400 / 1550



Lar

Lampy stojące
Floor lamps



LS-1/B

LS-1/W

Urlar

Lampy stojące
Floor lamps

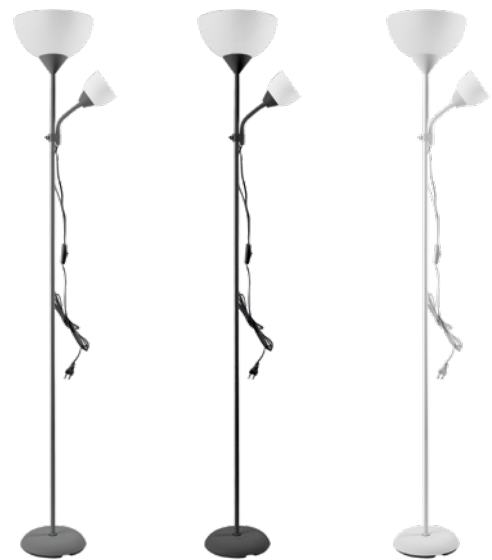

LS-2/G

LS-2/B

LS-2/W

Symbol Product no.	EAN	Napięcie nominalne Nominal voltage	Źródło światła Light source	Moc Power	Materiał klosza Lampshade material	Kolor obudowy Housing color	Średnica/wys. [mm] Diameter/H [mm]
LS-1/B	5908254816079	230V~, 50Hz	1 x E27	1 x 20W	Plastik / metal Plastic / metal	Czarny Black	Ø 250 / 1600
LS-1/W	5908254816086	230V~, 50Hz	1 x E27	1 x 20W	Plastik / metal Plastic / metal	Biały White	Ø 250 / 1600
LS-2/G	5908254816116	230V~, 50Hz	1 x E14 / 1 x E27	1 x 25W / 1 x 40W	Plastik / metal Plastic / metal	Szary Grey	Ø 250 / 1750
LS-2/B	5908254816123	230V~, 50Hz	1 x E14 / 1 x E27	1 x 25W / 1 x 40W	Plastik / metal Plastic / metal	Czarny Black	Ø 250 / 1750
LS-2/W	5908254816130	230V~, 50Hz	1 x E14 / 1 x E27	1 x 25W / 1 x 40W	Plastik / metal Plastic / metal	Biały White	Ø 250 / 1750

Lampki nocne

Night lamps

Adviti
LIGHTING SOLUTIONS

Rollo

Lampki nocne
Night lamps



AD-LD-6342WE27T



AD-LD-6342GNE27T



AD-LD-6342BE27T



AD-LD-6342YE27T



Źródło światła: E27
Light source: E27



Moc: 1x60W
Power: 1x60W



Kylo

Lampka nocna
Night lamp

AD-LD-6456BE27T



Vade

Lampka nocna
Night lamp

AD-LD-6457B-CE27T

Symbol Product no.	EAN	Napięcie nominalne Nominal voltage	Źródło światła Light source	Moc Power	Materiał klosza Lampshade material	Kolor klosza Lampshade color	Średnica/wys. [mm] Diameter/H [mm]
AD-LD-6342WE27T	5904988904884	230V~, 50Hz	1 x E27	1 x 60W	Tekstylny Textile	Biały White	Ø 170 / 400
AD-LD-6342GNE27T	5904988904891	230V~, 50Hz	1 x E27	1 x 60W	Tekstylny Textile	Butelkowa zieleń Bottle green	Ø 170 / 400
AD-LD-6342BE27T	5904988904907	230V~, 50Hz	1 x E27	1 x 60W	Tekstylny Textile	Czarny Black	Ø 170 / 400
AD-LD-6342YE27T	5904988904914	230V~, 50Hz	1 x E27	1 x 60W	Tekstylny Textile	Musztardowy Yellow	Ø 170 / 400
AD-LD-6456BE27T	5904988907311	230V~, 50Hz	1 x E27	1 x 60W	Tekstylny / tworzywo sztuczne Textile / plastic	Czarny Black	Ø 200 / 480
AD-LD-6457B-CE27T	5904988907328	230V~, 50Hz	1 x E27	1 x 60W	Tekstylny / tworzywo sztuczne Textile / plastic	Czarny Black	Ø 200 / 330

Dian

Lampki biurkowe przykręcane
Desk lamps



Źródło światła: E27
Light source: E27



Materiał klosza: Stal
Material cover: Steel



DL-13/B



DL-13/W

Symbol Product no.	EAN	Napięcie nominalne Nominal voltage	Źródło światła Light source	Moc Power	Materiał lampy Lamp material	Kolor obudowy Housing color	Wymiary (szer./wys./gł) [mm] Dimensions (W/H/D) [mm]
DL-13/B	5908254842788	230V~, 50Hz	1 x E27	1 x 60W	Stal Steel	Czarny Black	125 / 715 / 180
DL-13/W	5908254842771	230V~, 50Hz	1 x E27	1 x 60W	Stal Steel	Biały White	125 / 715 / 180

Deon

Lampki biurkowe przykręcane
Desk lamps



Źródło światła: E27
Light source: E27



Materiał klosza: Stal
Material cover: Steel



DL-14/B



DL-14/W

Symbol Product no.	EAN	Napięcie nominalne Nominal voltage	Źródło światła Light source	Moc Power	Materiał lampy Lamp material	Kolor obudowy Housing color	Wymiary (szer./wys./gł) [mm] Dimensions (W/H/D) [mm]
DL-14/W	5908254842795	230V~, 50Hz	1 x E27	1 x 60W	Stal Steel	Biały White	160 / 940 / 160
DL-14/B	5908254842801	230V~, 50Hz	1 x E27	1 x 60W	Stal Steel	Czarny Black	160 / 940 / 160

Dolomit LED

Lampki biurkowe z budzikiem
Desk lamps with alarmclock



Źródło światła: LED
Light source: LED



Temperatura barwowa: 4000K
Color temperature: 4000K



Moc: 5W
Power: 5W



Materiał lampy: Tworzywo sztuczne/skóra
Lamp material: Plastic/leather



DL-14/B



DL-12/BR

Symbol Product no.	EAN	Napięcie nominalne Nominal voltage	Moc Power	Strumień świetlny Luminous flux	Barwa światła Light color	Wskaźnik oddawania barw Ra/CRI Color rendering index Ra/CRI	Kolor obudowy Housing color	Wymiary (szer./wys./gł) [mm] Dimensions (W/H/D) [mm]
DL-12/B	5908254825927	230V~, 50Hz	5W	400lm	Neutralny biały Neutral white	80	Czarny Black	65 / 504 / 90
DL-12/BR	5908254825934	230V~, 50Hz	5W	400lm	Neutralny biały Neutral white	80	Brazowy Brown	65 / 504 / 90

Oprawy meblowe

Furniture luminaires

Adviti
LIGHTING SOLUTIONS

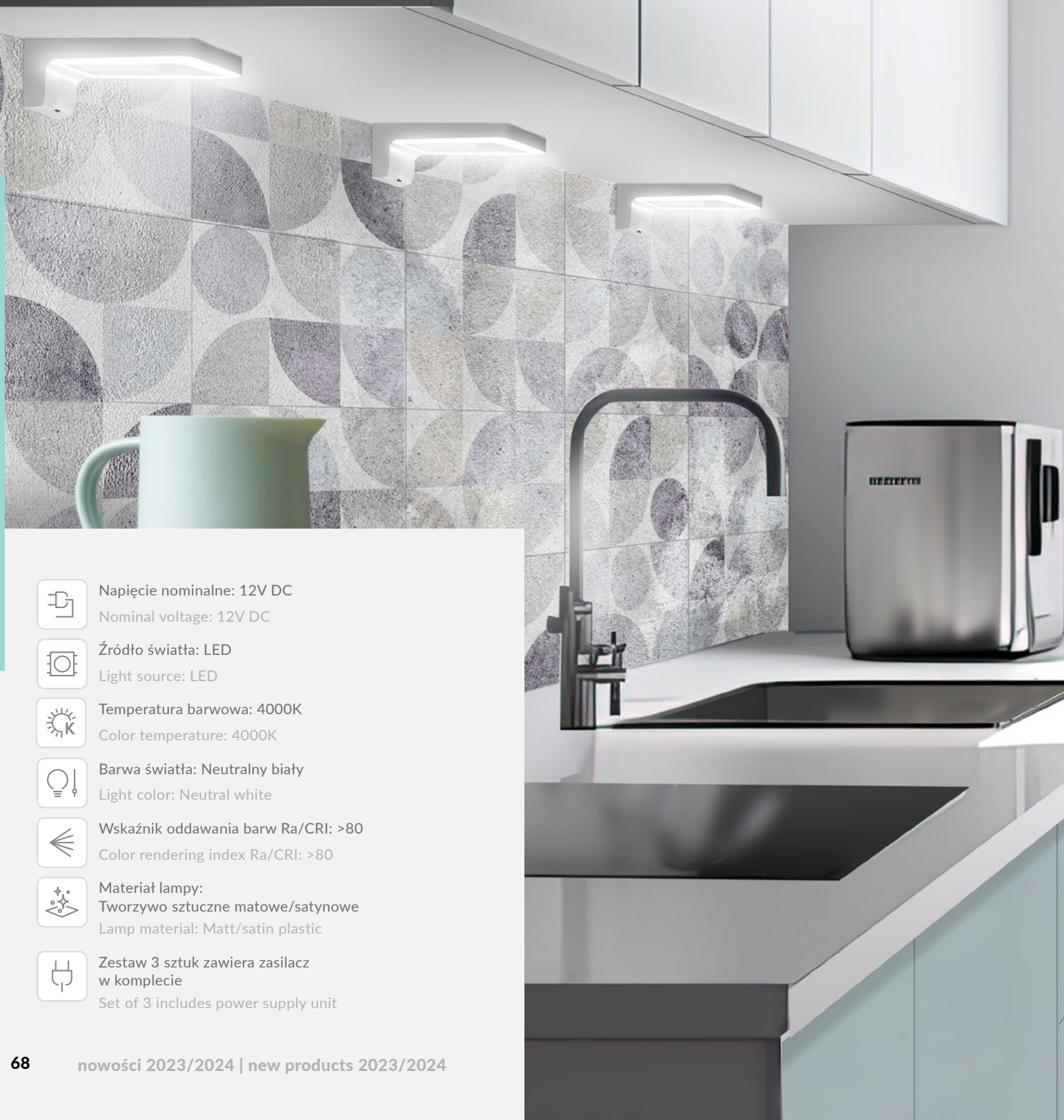

Napięcie nominalne: 12V DC
Nominal voltage: 12V DC



Źródło światła: LED
Light source: LED



Temperatura barwowa: 4000K
Color temperature: 4000K



Barwa światła: Neutralny biały
Light color: Neutral white



Wskaźnik oddawania barw Ra/CRI: >80
Color rendering index Ra/CRI: >80



Materiał lampy:
Tworzywo sztuczne matowe/satynowe
Lamp material: Matt/satin plastic



Zestaw 3 sztuk zawiera zasilacz
w komplecie
Set of 3 includes power supply unit

Oculus

Oprawa meblowa
Furniture luminaire



AD-OM-6473L4/G

Symbol Product no.	EAN	Moc Power	Strumień świetlny Luminous flux	Kolor obudowy Housing color	Średnica / wysokość [mm] Diameter / height [mm]
AD-OM-6473L4/G	5908254841279	2W	90lm	Szary Grey	Ø 68 / 19

Plana

Oprawy meblowe
Furniture luminaires

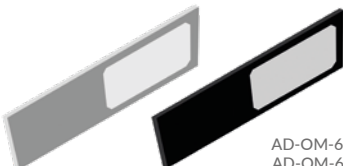

AD-OM-6476L4/G
AD-OM-6476L4/B

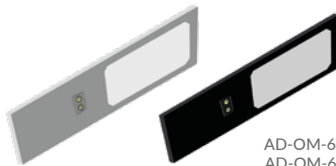

AD-OM-6476L4/G/SW
AD-OM-6476L4/B/SW

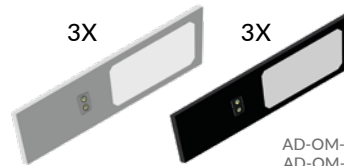

AD-OM-6477L4/G
AD-OM-6477L4/B

Symbol Product no.	EAN	Moc Power	Strumień świetlny Luminous flux	Kolor obudowy Housing color	Wymiary (szer./wys./gł) [mm] Dimensions (W/H/D) [mm]	Włącznik bezdotykowy Touchless switch	Funkcja ściemniania Dimming function
AD-OM-6476L4/G	5908254841347	4W	240lm	Szary Grey	50 / 6,8 / 168	-	-
AD-OM-6476L4/B	5908254841354	4W	240lm	Czarny Black	50 / 6,8 / 168	-	-
AD-OM-6476L4/G/SW	5908254841361	4W	240lm	Szary Grey	50 / 6,8 / 168	✓	✓
AD-OM-6476L4/B/SW	5908254841378	4W	240lm	Czarny Black	50 / 6,8 / 168	✓	✓
AD-OM-6477L4/G	5908254841385	3 x 4W	3 x 240lm	Szary Grey	50 / 6,8 / 168	✓	✓
AD-OM-6477L4/B	5908254841392	3 x 4W	3 x 240lm	Czarny Black	50 / 6,8 / 168	✓	✓

Artus

Oprawy meblowe
Furniture luminaires



AD-OM-6474L4/G
AD-OM-6474L4/B



AD-OM-6474L4/G/USB
AD-OM-6474L4/B/USB

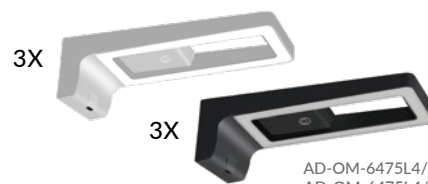

AD-OM-6475L4/G
AD-OM-6475L4/B

Symbol Product no.	EAN	Moc Power	Strumień świetlny Luminous flux	Kolor obudowy Housing color	Wymiary (szer./wys./gł) [mm] Dimensions (W/H/D) [mm]	Włącznik dotykowy Touch switch	Funkcja ściemniania Dimming function	Ładowanie USB USB charging
AD-OM-6474L4/G	5908254841286	3W	225lm	Szary Grey	50 / 65 / 160	-	-	-
AD-OM-6474L4/B	5908254841293	3W	225lm	Czarny Black	50 / 65 / 160	-	-	-
AD-OM-6474L4/G/USB	5908254841309	3W	225lm	Szary Grey	50 / 65 / 160	✓	✓	USB-C 5V 2,4A
AD-OM-6474L4/B/USB	5908254841316	3W	225lm	Czarny Black	50 / 65 / 160	✓	✓	USB-C 5V 2,4A
AD-OM-6475L4/G	5908254841323	3 x 3W	3 x 225lm	Szary Grey	50 / 65 / 160	✓	✓	USB-C 5V 2,4A
AD-OM-6475L4/B	5908254841330	3 x 3W	3 x 225lm	Czarny Black	50 / 65 / 160	✓	✓	USB-C 5V 2,4A



Oświetlenie szynowe

Track lighting

Reflektor na szynę

Track light fixture

ViRONE
simple made easy.

-  Źródło światła: GU10
Light source: GU10
-  Moc: 35W
Power: 35W
-  Materiał lampy: Aluminium
Lamp material: Aluminium

Jari

Reflektor na szynę
Track light fixture



TL-2/W

TL-2/B

Mala

Reflektor na szynę
Track light fixture



TL-3/W

TL-3/B

Symbol Product no.	EAN	Napięcie nominalne Nominal voltage	Moc Power	Materiał lampy Lamp material	Kolor obudowy Housing color	Średnica/wys. [mm] Diameter/H [mm]
TL-2/W	5908254827747	230V~, 50Hz	35W	Aluminium	Biały White	Ø 60 / 140
TL-2/B	5908254827730	230V~, 50Hz	35W	Aluminium	Czarny Black	Ø 60 / 140
TL-3/W	5908254827761	230V~, 50Hz	35W	Aluminium	Biały White	Ø 55 / 100
TL-3/B	5908254827754	230V~, 50Hz	35W	Aluminium	Czarny Black	Ø 55 / 100

Szynoprzewody

Light tracks



TR-3/W/2M
TR-3/B/2M



TR-2/W/1M
TR-2/B/1M



Napięcie nominalne: 85-265 V
Nominal voltage: 85-265 V



Max. moc: 600W
Max. power: 600W



Materiał lampy: Aluminium
Lamp material: Aluminium

Symbol Product no.	EAN	Napięcie nominalne Nominal voltage	Max. moc Max. power	Materiał Material	Kolor obudowy Housing color	Liczba przewodów Number of wires	Wymiary (szer./wys./gt. [mm]) Dimensions (W/H/D [mm])	Ilość faz Number of phases
TR-2/W/1M	5908254827600	85-265 V	600W	Aluminium	Biały White	2	39 / 1000 / 11	1
TR-2/B/1M	5908254827594	85-265 V	600W	Aluminium	Czarny Black	2	39 / 1000 / 11	1
TR-3/W/2M	5908254827617	85-265 V	600W	Aluminium	Biały White	2	38 / 2000 / 11	1
TR-3/B/2M	5908254827624	85-265 V	600W	Aluminium	Czarny Black	2	38 / 2000 / 11	1

Akcesoria

Accessories



TC-2/W/I
TC-2/B/I

TC-2/W/L
TC-2/B/L

TC-2/W/AD
TC-2/B/AD

TC-3/W
TC-3/B

TC-4/W
TC-4/B

Symbol Product no.	EAN	Materiał Material	Kolor obudowy Housing color	Wymiary (szer./dł.) [mm] Dimensions (W/L) [mm]
TC-2/W/I	5908254827648	Tworzywo sztuczne Plastic	Biały White	36 / 94
TC-2/B/I	5908254827631	Tworzywo sztuczne Plastic	Czarny Black	36 / 94
TC-2/W/L	5908254827662	Tworzywo sztuczne Plastic	Biały White	65 / 65
TC-2/B/L	5908254827655	Tworzywo sztuczne Plastic	Czarny Black	65 / 65
TC-2/W/AD	5908254827686	Tworzywo sztuczne Plastic	Biały White	35 / 135
TC-2/B/AD	5908254827679	Tworzywo sztuczne Plastic	Czarny Black	35 / 135
TC-3/W	5908254827709	Tworzywo sztuczne Plastic	Biały White	39 / 100
TC-3/B	5908254827693	Tworzywo sztuczne Plastic	Czarny Black	39 / 100
TC-4/W	5908254827723	Tworzywo sztuczne Plastic	Biały White	31,5 / 20,5
TC-4/B	5908254827716	Tworzywo sztuczne Plastic	Czarny Black	31,5 / 20,5

Oświetlenie przemysłowe

Industrial lighting

Vumbi

Oprawy hermetyczne
Hermetic luminaires



Źródło światła: T8 LED (brak w zestawie)
Light source: T8 LED (not included)



Stopień ochrony: IP54
Ingress protection: IP54



Kolor obudowy: Szary
Housing color: Grey



Odbłyśnik
Reflector



DS-5

DS-6

DS-7

Symbol Product no.	EAN	Napięcie nominalne Nominal voltage	Materiał Material	Stopień ochrony IP Ingress protection IP	Wymiary (szer./wys./gł. [mm]) Dimensions (W/H/D [mm])
DS-5	5904988900206	230V~, 50Hz	Tworzywo sztuczne Plastic	IP54	100 / 663 / 78
DS-6	5904988900213	230V~, 50Hz	Tworzywo sztuczne Plastic	IP54	100 / 1262 / 78
DS-7	5904988900220	230V~, 50Hz	Tworzywo sztuczne Plastic	IP54	100 / 1560 / 78

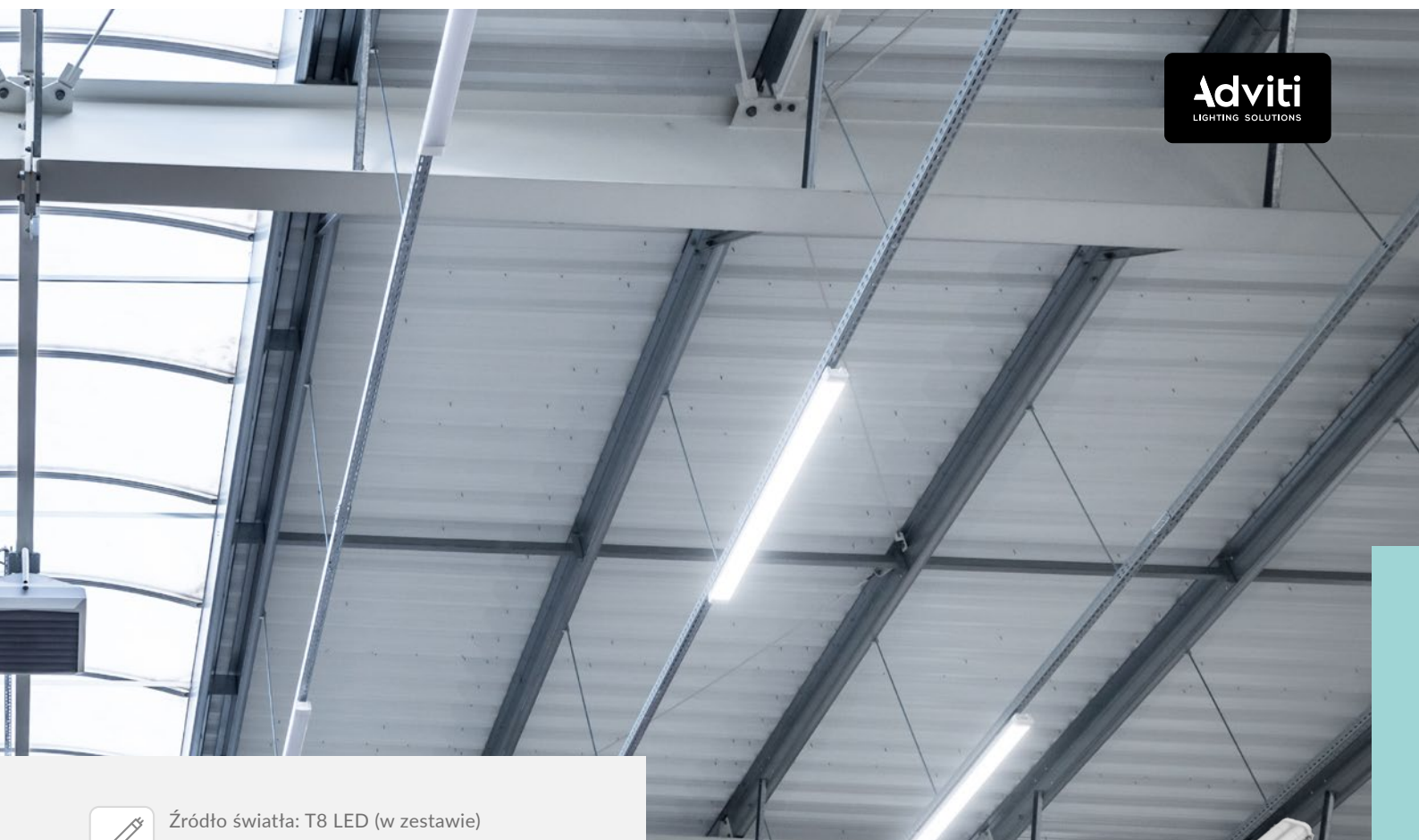

Źródło światła: T8 LED (w zestawie)
Light source: T8 LED (included)



Stopień ochrony: IP65
Ingress protection: IP65



Temperatura barwowa: 4000K
Color temperature: 4000K



Barwa światła: Neutralny biały
Light color: Neutral white



Kolor obudowy: Szary
Housing color: Grey



Zasilanie źródła światła: jednostronne
Power supply for light source: single-sided



DS-3

DS-2

DS-4

Symbol Product no.	EAN	Napięcie nominalne Nominal voltage	Moc Power	Strumień światłny Luminous flux	Barwa światła Light color	Wskaźnik oddawania barw Ra/CRI Color rendering index Ra/CRI	Materiał Material	Stopień ochrony IP Ingress protection IP	Wymiary (szer./wys./gł. [mm]) Dimensions (W/H/D [mm])
DS-3	5908254818523	230V~, 50Hz	2x9W	1800lm	Neutralny biały Neutral white	80	ABS+PS	IP65	62 / 660 / 91
DS-2	5908254814495	230V~, 50Hz	2x18W	3600lm	Neutralny biały Neutral white	80	ABS+PS	IP65	62 / 1276 / 91
DS-4	5908254818516	230V~, 50Hz	2x22W	4800lm	Neutralny biały Neutral white	80	ABS+PS	IP65	62 / 1562 / 91

Naświetlacze

Floodlights

Porto LED

Naświetlacze
Floodlights

Adviti
LIGHTING SOLUTIONS



AD-NL-6462BL4



AD-NL-6463BL4



AD-NL-6464BL4



AD-NL-6465BL4



Źródło światła: LED
Light source: LED



Stopień ochrony: IP65/IK08
Protection level: IP65/IK08



Temperatura barwowa: 4000K
Color temperature: 4000K



Wskaźnik oddawania barw Ra/CRI: >80
Color rendering index Ra/CRI: >80



Barwa światła: Neutralny Biały
Light color: Neutral White



Materiał: Aluminium / Tworzywo sztuczne
Material: Aluminium / Plastic

Symbol Product no.	EAN	Moc Power	Strumień świetlny Luminous flux	Materiał klosza Lampshade material	Kolor klosza Lampshade color	Wymiary (szer./wys./gł.) [mm] Dimensions (W/H/D) [mm]
AD-NL-6462BL4	5908254840449	10W	800lm	Tworzywo sztuczne Plastic	Biały White	101 / 72 / 28
AD-NL-6463BL4	5908254840692	20W	1600lm	Tworzywo sztuczne Plastic	Biały White	114 / 94 / 28
AD-NL-6464BL4	5908254840715	30W	2400lm	Tworzywo sztuczne Plastic	Biały White	144 / 126 / 28
AD-NL-6465BL4	5908254840739	50W	4000lm	Tworzywo sztuczne Plastic	Biały White	187 / 147 / 28

Porto S LED

Naświetlacze z czujnikiem ruchu PIR
Floodlights with PIR motion sensor

Adviti
LIGHTING SOLUTIONS



AD-NL-6462BLR4



AD-NL-6463BLR4



AD-NL-6464BLR4



AD-NL-6465BLR4



Źródło światła: LED
Light source: LED



Czujnik ruchu: PIR
Motion sensor: PIR



Kąt detekcji: 120°
Detection angle: 120°



Stopień ochrony: IP44, IK08
Protection level: IP44, IK08



Temperatura barwowa: 4000K
Color temperature: 4000K



Barwa światła: Neutralny Biały
Light color: Neutral White



Wskaźnik oddawania barw Ra/CRI: >80
Color rendering index Ra/CRI: >80



Materiał: Aluminium / Tworzywo sztuczne
Material: Aluminium / Plastic

Symbol Product no.	EAN	Moc Power	Strumień światłny Luminous flux	Materiał klosza Lampshade material	Kolor klosza Lampshade color	Wymiary (szer./wys./gł.) [mm] Dimensions (W/H/D) [mm]	Zasięg detekcji Detection range	Regulacja natężenia światła LUX Adjustable daylight sensor LUX	Regulacja czasu świecenia TIME Adjustable time setting TIME
AD-NL-6462BLR4	5908254840456	10W	800lm	Tworzywo sztuczne Plastic	Biały White	135 / 90 / 48	Ø 0,5-8m	5 - 2000lux	5-600s
AD-NL-6463BLR4	5908254840708	20W	1600lm	Tworzywo sztuczne Plastic	Biały White	155 / 110 / 48	Ø 0,5-8m	5 - 2000lux	5-600s
AD-NL-6464BLR4	5908254840722	30W	2400lm	Tworzywo sztuczne Plastic	Biały White	190 / 140 / 48	Ø 0,5-8m	5 - 2000lux	5-600s
AD-NL-6465BLR4	5908254840746	50W	4000lm	Tworzywo sztuczne Plastic	Biały White	200 / 175 / 48	Ø 0,5-8m	5 - 2000lux	5-600s

Solis LED

Naświetlacz solarny z czujnikiem ruchu PIR
Solar floodlight with PIR motion sensor



Zasilanie: 3,7V Li-ion
Power supply: 3,7V Li-ion



Panel solarny: CdTe cienkowarstwowy
Solar panel: CdTe thin-film



Źródło światła: LED
Light source: LED



Czujnik ruchu: PIR
Motion sensor: PIR



Kąt detekcji: 120°
Detection angle: 120°



Temperatura barwowa: 4000K
Color temperature: 4000K



Barwa światła: Neutralny Biały
Light color: Neutral White



Wskaźnik oddawania barw Ra/CRI: >80
Color rendering index Ra/CRI: >80



Materiał klosza: PC
Lampshade material: PC



Symbol Product no.	EAN	Moc Power	Strumień światłny Luminous flux	Stopień ochrony IP Ingress protection IP	Klasa IK (odporność na uderzenia) Impact protection IK	Kolor klosza Lampshade color	Wymiary (szer./wys./gł.) [mm] Dimensions (W/H/D) [mm]	Zasięg detekcji Detection range	Regulacja natężenia światła LUX Adjustable daylight sensor LUX	Regulacja czasu świecenia TIME Adjustable time setting TIME
AD-SL-6467BLR4	5908254840777	10W	1200lm	IP54	IK06	Biały White	290 / 178 / 140	Ø 0,5- 8m	15-1000 lux	10-60s

Girlandy oświetleniowe

Lighting garlands

ViRONE
simple made easy.



 Zapasowa żarówka w zestawie
Replacement light bulb included

 Źródło światła: E27
Light source: E27

 Temperatura barwowa: 3000K
Color temperature: 3000K

 Barwa światła: Ciepły Biały
Light color: Warm White

Symbol Product no.	EAN	Ilość opravek Number of bulb holders	Źródło światła Light source	Moc źródła światła Power of light source	Strumień światłny Luminous flux	Wskaźnik oddawania barw Ra/CRI	Stopień ochrony IP Ingress protection IP	Długość przewodu [m] Cable length [m]
LG-1/5M/E27/3	5904988905256	5 x E27	Żarówka LED filament LED filament bulb	1W	80lm	>80	IP44	5
LG-2/5M/E27/3	5904988905263	10 x E27	Żarówka LED filament LED filament bulb	1W	80lm	>80	IP44	5
LG-1/10M/E27/3	5904988901883	10 x E27	Żarówka LED filament LED filament bulb	1W	80lm	>80	IP44	10
LG-1/15M/E27/3	5904988901890	15 x E27	Żarówka LED filament LED filament bulb	1W	80lm	>80	IP44	15
LG-1/20M/E27/3	5904988901906	20 x E27	Żarówka LED filament LED filament bulb	1W	80lm	>80	IP44	20
LG-2/20M/E27/3	5904988905270	40 x E27	Żarówka LED filament LED filament bulb	1W	80lm	>80	IP44	20

Halit LED

Oprawa ogrodowa z czujnikiem ruchu Garden luminaire with motion sensor

 Źródło światła: LED SMD
Light source: LED SMD

 Czujnik ruchu: PIR
Motion sensor: PIR

 Kąt detekcji: 140°
Detection angle: 140°

 Temperatura barwowa: 4000K
Color temperature: 4000K

 Barwa światła: Neutralny Biały
Light color: Neutral White

 Wskaźnik oddawania barw Ra/CRI: >80
Color rendering index Ra/CRI: >80

 Materiał klosza: PC
Lampshade material: PC



Adviti
LIGHTING SOLUTIONS

Symbol Product no.	EAN	Moc Power	Strumień światłny Luminous flux	Stopień ochrony IP Ingress protection IP	Kolor obudowy Housing color	Średnica/gł. ([mm] Diameter/D [mm]	Zasięg detekcji Detection range	Regulacja natężenia światła LUX Adjustable daylight sensor LUX	Regulacja czasu świecenia TIME Adjustable time setting TIME
AD-OP-6116BLPMR4	5908254828768	10W	600lm	IP65	Czarny Black	180 / 35	Ø 0,5-9m	<3 - 2000lux	min: 10 s. ± 3 s.; max: 5 min. ± 1 min.

Oświetlenie robocze

Workshop lights

Latarki warsztatowe Work lights

ViRONE
simple made easy.



Napięcie nominalne: 230V~, 50Hz
Nominal voltage: 230V~, 50Hz



Barwa światła: Zimna biel
Light color: Cool white



Wskaźnik oddawania barw Ra/CRI: >80
Color rendering index Ra/CRI: >80



Ładowanie USB
USB charger



WL-12



WL-13

Symbol Product no.	EAN	Zasilanie Power supply	Źródło światła Light source	Moc Power	Strumień świetlny Luminous flux	Temperatura barwowa Color temperature	Barwa światła Light color	Materiał obudowy Housing material	Wymiary (szer./wys./gł.) [mm] Dimensions (W/H/D) [mm]
WL-12	5908254840784	akumulator 1200mAh	COB LED, dioda SMD	2W	200lm	6500K	Zimna biel Cool white	Tworzywo sztuczne/ aluminium Plastic/aluminium	48 / 270 / 35
WL-13	5908254840791	akumulator 1500mAh	LED	5W	600lm	6000K	Zimna biel Cool white	Tworzywo sztuczne Plastic	35 / 395 / 35

Symbol Product no.	EAN	Napięcie nominalne Nominal voltage	Źródło światła Light source	Moc Power	Materiał klosza Lampshade material	Kolor obudowy Housing color	Wymiary (szer./wys./gł.) [mm] Dimensions (W/H/D) [mm]
WL-11	5908254829253	230V~, 50Hz	1 x E27	1 x 60W	Szkoło Glass	Czarny Black	150 / 300 / 120



Naświetlacze robocze na statywie

Work floodlights on stand

Adviti
LIGHTING SOLUTIONS



Napięcie nominalne: 230V~, 50Hz
Nominal voltage: 230V~, 50Hz



Wskaźnik oddawania barw
Ra/CRI: >80
Color rendering index Ra/CRI: >80



AD-NR-6247L6



AD-NR-6466L4



Zasilanie:
Akumulator Li-Po
Power supply:
Li-Po battery



Ładowanie USB
USB charger

Symbol	EAN	Źródło światła	Moc	Strumień świetlny	Temperatura barwowa	Barwa światła	Materiał obudowy	Stopień ochrony IP	Klasa IK (odporność na uderzenia)	Wymiary (szer./wys./gł.) [mm]
Product no.		Light source	Power	Luminous flux	Color temperature	Light color	Housing material	Ingress protection IP	Impact protection IK	Dimensions (W/H/D) [mm]
AD-NR-6247L6	5908254825156	LED SMD	50W	4000lm	6000K	Zimna biel Cool white	Aluminium	IP65	IK06	190 / 150 / 30
AD-NR-6466L4	5908254840760	COB LED	2 x 10W	1200lm	4000K	Neutralny biały Neutral white	Nylon + guma Nylon + rubber	IP44	IK08	200 / 135 / 60

Horin LED

Oprawa typu highbay
High-bay industrial light

Adviti
LIGHTING SOLUTIONS



Źródło światła: LED SMD
Light source: LED SMD



Moc: 200W
Power: 200W



Temperatura barwowa: 4000K
Color temperature: 4000K



Barwa światła: Neutralny biały
Light color: Neutral white



Symbol	EAN	Moc	Strumień świetlny	Wskaźnik oddawania barw Ra/CRI	Stopień ochrony	Materiał obudowy	Kolor obudowy	Wymiary (szer./wys./gł.) [mm]
Product no.		Power	Luminous flux	Color rendering index Ra/CRI	Ingress protection IP	Housing material	Housing color	Dimensions (W/H/D) [mm]
AD-OP-6210L4	5908254823084	200W	18000lm	80	IP65	Aluminium / szkło Aluminium / glass	Czarny Black	149,5 / 390 / 89,5

Latarka LED

LED flashlight

VIRONE
simple made easy.



Źródło światła: LED
Light source: LED



Temperatura barwowa: 6000K
Color temperature: 6000K



Barwa światła: Zimna biel
Light color: Cool White



Wskaźnik oddawania barw Ra/CRI: >80
Color rendering index Ra/CRI: >80



Funkcja zoom
Zoom function



Symbol Product no.	EAN	Zasilanie Power supply	Moc Power	Strumień świetlny Luminous flux	Materiał Material	Stopień ochrony IP Ingress protection IP	Klasa IK (odporność na uderzenia) Impact protection IK	Kolor obudowy Housing color	Wymiary (szer./wys./gł.) [mm] Dimensions (W/H/D) [mm]	Ładowanie USB USB charging
LT-12	5908254827822	Akumulator 2200 mAh Battery 2200 mAh	12W	500lm	Aluminium	IPX3	IK09	Czarny Black	50 / 150 / 30	✓

Latarki czołowe LED LED Headlamps

ViRONE
simple made easy.



LT-7



LT-8



LT-9



LT-10



LT-13/BL

LT-13/B



LT-14



Temperatura barwowa: 6000K

Color temperature: 6000K



Barwa światła: Zimna biel

Light color: Cool White



Wskaźnik oddawania barw Ra/CRI: >80

Color rendering index Ra/CRI: >80

Symbol	EAN	Zasilanie	Źródło światła	Moc	Strumień świetlny	Materiał	Stopień ochrony IP	Kolor obudowy	Wymiary (szer./wys./gł.) [mm]	Ładowanie USB	Czujnik ruchu
Product no.		Power supply	Light source	Power	Luminous flux	Material	Ingress protection IP	Housing color	Dimensions (W/H/D) [mm]	USB charging	Motion sensor
LT-7	5908254827778	3 x AAA	LED COB	1W	45lm	Tworzywo sztuczne Plastic	IPX3	Czarny Black	66 / 42 / 40	-	-
LT-8	5908254827785	3 x AAA	LED CREE	3W	70lm	Tworzywo sztuczne Plastic	IPX3	Czarny Black	60 / 63 / 45	-	-
LT-9	5908254827792	Akumulator 1200mAh Battery 1200mAh	LED COB/LED CREE	3-10W	200lm	Aluminium	IPX4	Czarny Black	70 / 130 / 105	✓	-
LT-10	5908254827808	Akumulator 1200mAh Battery 1200mAh	LED COB/LED XPE	5/3W	350lm	Guma Rubber	IPX4	Czarny Black	32 / 300 / 22	✓	-
LT-13/BL	5908254827969	Akumulator 1200mAh Battery 1200mAh	LED COB/LED SMD	3W	350lm	Tworzywo sztuczne Plastic	IPX4	Niebieski Blue	60 / 30 / 42	✓	✓
LT-13/B	5908254827976	Akumulator 1200mAh Battery 1200mAh	LED COB/LED SMD	3W	350lm	Tworzywo sztuczne Plastic	IPX4	Czarny Black	60 / 30 / 42	✓	✓
LT-14	5908254842818	Akumulator 1200mAh Battery 1200mAh	LED COB/XPG	1/3W	90/170lm	Tworzywo sztuczne Plastic	IPX4	Czarny Black	44 / 91,5 / 33	✓	✓

Taśmy LED

LED Strips



AD-TL-6486L3
AD-TL-6486L4
AD-TL-6486L6



AD-TL-6488L3
AD-TL-6488L4
AD-TL-6488L6



AD-TL-6487L3
AD-TL-6487L4
AD-TL-6487L6



AD-TL-6489L3
AD-TL-6489L4
AD-TL-6489L6



AD-TL-6490LRGB

3 longlife
YEARS WARRANTY

Taśmy LED Standard Standard LED Strips



Symbol	EAN	Zasilanie	Źródło światła	Moc	Strumień świetlny	Temperatura barwowa	Barwa światła	Wskaźnik oddawania barw Ra/CRI	Liczba punktów świetlnych	Stopień ochrony IP	Wymiary (szerokość / długość) [mm]
Product no.		Power supply	Light source	Power	Luminous flux	Color temperature	Light color	Color rendering index Ra/CRI	Number of diodes	Ingress protection IP	Dimensions (W / L) [mm]
AD-TL-6486L3	5908254841866	12V DC	LED SMD 2835	4,8W/m	480lm/m	3000K	Ciepła biel Warm White	>80	60 LED/m	IP20	8 / 5000
AD-TL-6486L4	5908254841873	12V DC	LED SMD 2835	4,8W/m	504lm/m	4000K	Neutalna biel Neutral White	>80	60 LED/m	IP20	8 / 5000
AD-TL-6486L6	5908254841880	12V DC	LED SMD 2835	4,8W/m	528lm/m	6000K	Zimna biel Cool White	>80	60 LED/m	IP20	8 / 5000
AD-TL-6487L3	5908254841897	12V DC	LED SMD 2835	4,8W/m	480lm/m	3000K	Ciepła biel Warm White	>80	60 LED/m	IP63	8 / 5000
AD-TL-6487L4	5908254841903	12V DC	LED SMD 2835	4,8W/m	504lm/m	4000K	Neutalna biel Neutral White	>80	60 LED/m	IP63	8 / 5000
AD-TL-6487L6	5908254841910	12V DC	LED SMD 2835	4,8W/m	528lm/m	6000K	Zimna biel Cool White	>80	60 LED/m	IP63	8 / 5000
AD-TL-6488L3	5908254841927	12V DC	LED SMD 2835	9,6W/m	960lm/m	3000K	Ciepła biel Warm White	>80	120 LED/m	IP20	8 / 5000
AD-TL-6488L4	5908254841934	12V DC	LED SMD 2835	9,6W/m	1008lm/m	4000K	Neutalna biel Neutral White	>80	120 LED/m	IP20	8 / 5000
AD-TL-6488L6	5908254841941	12V DC	LED SMD 2835	9,6W/m	1056lm/m	6000K	Zimna biel Cool White	>80	120 LED/m	IP20	8 / 5000
AD-TL-6489L3	5908254841958	12V DC	LED SMD 2835	9,6W/m	960lm/m	3000K	Ciepła biel Warm White	>80	120 LED/m	IP63	8 / 5000
AD-TL-6489L4	5908254841965	12V DC	LED SMD 2835	9,6W/m	1008lm/m	4000K	Neutalna biel Neutral White	>80	120 LED/m	IP63	8 / 5000
AD-TL-6489L6	5908254841972	12V DC	LED SMD 2835	9,6W/m	1056lm/m	6000K	Zimna biel Cool White	>80	120 LED/m	IP63	8 / 5000
AD-TL-6490LRGB	5908254841989	12V DC	LED SMD 5050	14,4W/m	210lm/m	-	RGB	>80	60 LED/m	IP63	10 / 5000



AD-TL-6491L3
AD-TL-6491L4
AD-TL-6491L6

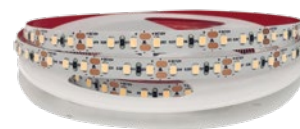

AD-TL-6492L3
AD-TL-6492L4
AD-TL-6492L6



AD-TL-6493LRGBW
AD-TL-6494LRGBW



Taśmy LED Premium Premium LED strips



Źródło światła: diody LED Samsung
Light source: Samsung LED diodes



Wydłużona żywotność
Extended lifetime

Symbol	EAN	Zasilanie	Źródło światła	Moc	Strumień świetlny	Temperatura barwowa	Barwa światła	Wskaźnik oddawania barw Ra/CRI	Liczba punktów świetlnych	Stopień ochrony IP	Wymiary (szerokość / długość) [mm]
Product no.		Power supply	Light source	Power	Luminous flux	Color temperature	Light color	Color rendering index Ra/CRI	Number of diodes	Ingress protection IP	Dimensions (W / L) [mm]
AD-TL-6491L3	5908254841996	12V DC	LED SMD 2835	6W/m	633lm/m	3000K	Ciepła biel Warm White	>80	60 LED/m	IP20	8 / 5000
AD-TL-6491L4	5908254842009	12V DC	LED SMD 2835	6W/m	645lm/m	4000K	Neutralna biel Neutral White	>80	60 LED/m	IP20	8 / 5000
AD-TL-6491L6	5908254842016	12V DC	LED SMD 2835	6W/m	658lm/m	6000K	Zimna biel Cool White	>80	60 LED/m	IP20	8 / 5000
AD-TL-6492L3	5908254842023	12V DC	LED SMD 2835	12W/m	1233lm/m	3000K	Ciepła biel Warm White	>80	120 LED/m	IP20	8 / 5000
AD-TL-6492L4	5908254842030	12V DC	LED SMD 2835	12W/m	1254lm/m	4000K	Neutralna biel Neutral White	>80	120 LED/m	IP20	8 / 5000
AD-TL-6492L6	5908254842047	12V DC	LED SMD 2835	12W/m	1256lm/m	6000K	Zimna biel Cool White	>80	120 LED/m	IP20	8 / 5000
AD-TL-6493LRGBW	5908254842054	12V DC	LED SMD 5050	14,4W/m	330lm/m	-	RGBW	>80	60 LED/m	IP20	12 / 5000
AD-TL-6494LRGBW	5908254842061	12V DC	LED SMD 5050	14,4W/m	330lm/m	-	RGBW	>80	60 LED/m	IP65	12 / 5000



Taśmy LED COB

LED COB strips



AD-TL-6495L3
 AD-TL-6495L4
 AD-TL-6495L6



AD-TL-6496RGB

Symbol	EAN	Zasilanie	Źródło światła	Moc	Strumień świetlny	Temperatura barwowa	Barwa światła	Wskaźnik oddawania barw Ra/CRI	Liczba punktów świetlnych	Stopień ochrony IP	Wymiary (szerokość / długość) [mm]
Product no.		Power supply	Light source	Power	Luminous flux	Color temperature	Light color	Color rendering index Ra/CRI	Number of diodes	Ingress protection IP	Dimensions (W / L) [mm]
AD-TL-6495L3	5908254842078	12V DC	COB LED	10W/m	800lm/m	3000K	Ciepła biel Warm White	>80	480 LED/m	IP20	10 / 5000
AD-TL-6495L4	5908254842085	12V DC	COB LED	10W/m	850lm/m	4000K	Neutralna biel Neutral White	>80	480 LED/m	IP20	10 / 5000
AD-TL-6495L6	5908254842092	12V DC	COB LED	10W/m	900lm/m	6000K	Zimna biel Cool White	>80	480 LED/m	IP20	10 / 5000
AD-TL-6496RGB	5908254842108	12V DC	COB LED	15W/m	422lm/m	-	RGB	>80	840 LED/m	IP20	10 / 5000

Taśmy LED Basic

Basic LED Strips



LD-9/5M/3
LD-9/5M/4
LD-9/5M/6



LD-10/5M/3
LD-10/5M/4
LD-10/5M/6



LD-11/5M/3
LD-11/5M/4
LD-11/5M/6



LD-12/5M/3
LD-12/5M/4
LD-12/5M/6



LD-13/5M/RGB

Symbol	EAN	Zasilanie	Źródło światła	Moc	Strumień świetlny	Temperatura barwowa	Barwa światła	Wskaźnik oddawania barw Ra/CRI	Liczba punktów świetlnych	Stopień ochrony IP	Wymiary (szerokość / długość) [mm]
Product no.		Power supply	Light source	Power	Luminous flux	Color temperature	Light color	Color rendering index Ra/CRI	Number of diodes	Ingress protection IP	Dimensions (W / L) [mm]
LD-9/5M/3	5908254841736	12V DC	LED SMD 2835	4,8W/m	480lm/m	3000K	Ciepła biel Warm White	>80	60 LED/m	IP20	8 / 5000
LD-9/5M/4	5908254841743	12V DC	LED SMD 2835	4,8W/m	504lm/m	4000K	Neutralna biel Neutral White	>80	60 LED/m	IP20	8 / 5000
LD-9/5M/6	5908254841750	12V DC	LED SMD 2835	4,8W/m	528lm/m	6000K	Zimna biel Cool White	>80	60 LED/m	IP20	8 / 5000
LD-10/5M/3	5908254841767	12V DC	LED SMD 2835	4,8W/m	480lm/m	3000K	Ciepła biel Warm White	>80	60 LED/m	IP63	8 / 5000
LD-10/5M/4	5908254841774	12V DC	LED SMD 2835	4,8W/m	504lm/m	4000K	Neutralna biel Neutral White	>80	60 LED/m	IP63	8 / 5000
LD-10/5M/6	5908254841781	12V DC	LED SMD 2835	4,8W/m	528lm/m	6000K	Zimna biel Cool White	>80	60 LED/m	IP63	8 / 5000
LD-11/5M/3	5908254841798	12V DC	LED SMD 2835	9,6W/m	960lm/m	3000K	Ciepła biel Warm White	>80	120 LED/m	IP20	8 / 5000
LD-11/5M/4	5908254841804	12V DC	LED SMD 2835	9,6W/m	1008lm/m	4000K	Neutralna biel Neutral White	>80	120 LED/m	IP20	8 / 5000
LD-11/5M/6	5908254841811	12V DC	LED SMD 2835	9,6W/m	1056lm/m	6000K	Zimna biel Cool White	>80	120 LED/m	IP20	8 / 5000
LD-12/5M/3	5908254841828	12V DC	LED SMD 2835	9,6W/m	960lm/m	3000K	Ciepła biel Warm White	>80	120 LED/m	IP63	8 / 5000
LD-12/5M/4	5908254841835	12V DC	LED SMD 2835	9,6W/m	1008lm/m	4000K	Neutralna biel Neutral White	>80	120 LED/m	IP63	8 / 5000
LD-12/5M/6	5908254841842	12V DC	LED SMD 2835	9,6W/m	1056lm/m	6000K	Zimna biel Cool White	>80	120 LED/m	IP63	8 / 5000
LD-13/5M/RGB	5908254841859	12V DC	LED SMD 5050	14,4W/m	210lm/m	-	RGB	>80	60 LED/m	IP63	10 / 5000

Zestaw: taśma LED + sterownik RGB + zasilacz

LED lighting set: LED strip + RGB controller + power supply unit



LD-8/3M/RGB/SET
LD-8/5M/RGB/SET

Symbol	EAN	Zasilanie	Źródło światła	Moc	Strumień świetlny	Barwa światła	Wskaźnik oddawania barw Ra/CRI	Stopień ochrony IP	Wymiary (szerokość / długość) [mm]
Product no.		Power supply	Light source	Power	Luminous flux	Light color	Color rendering index Ra/CRI	Ingress protection IP	Dimensions (W / L) [mm]
LD-8/3M/RGB/SET	5904988906956	12V DC	LED SMD 5050	7,2W/m	100lm/m	RGB	>80	IP20	10 / 3000
LD-8/5M/RGB/SET	5904988906963	12V DC	LED SMD 5050	7,2W/m	100lm/m	RGB	>80	IP20	10 / 5000

Elementy taśm LED

LED strip components

Adviti
LIGHTING SOLUTIONS

Bezprzewodowe sterowniki do taśm LED Tuya Tuya wireless LED strips controllers



Droga sterowania: aplikacja Tuya
Control method: Tuya app



Częstotliwość transmisji: 433,92 mHz
Transmission frequency: 433.92 mHz



Rodzaj sterowania: RF
Control type: RF



AD-TL-6501



AD-TL-6501/RGB



AD-TL-6501/RGBW

Symbol	EAN	Zastosowanie	Zasięg komunikacji	Zakres napięcia wejściowego-wyjściowego	Ilość kanałów koloru	Nateżenie prądu/kanał	Maks. moc taśmy	Wymiary (szer./wys./gt.) [mm]	Kompatybilny z Tuya	Kompatybilny z Asystentem Google	Kompatybilny z Amazon Alexa
Product no.		Application	Communication range	Input-Output voltage range	Number of colour channels	Current per channel	Max. Led strip power	Dimensions (W/H/D) [mm]	Compatible with TUYA	Compatible with Google Assistant	Compatible with Amazon Alexa
AD-TL-6501	5908254842399	Taśmy LED mono LED strips	30m	5-24V	1	6A	12V 72W	89 / 48 / 23,5	✓	✓	✓
AD-TL-6501/RGB	5908254842405	Taśmy LED RGB RGB LED strips	30m	5-24V	3	6A	12V 216W	89 / 48 / 23,5	✓	✓	✓
AD-TL-6501/RGBW	5908254842412	Taśmy LED RGBW RGBW LED strips	30m	5-24V	4	6A	12V 288W	89 / 48 / 23,5	✓	✓	✓

Bezprzewodowy sterownik do taśm LED z pilotem

Wireless LED strip controller with remote control



AD-TL-6500/P11

AD-TL-6500/P17



Rodzaj sterowania: RF
Control type: RF



Droga sterowania: pilot
Control method: remote control



Zasilanie pilota: 3V CR2025
Remote control power supply: 3V CR2025



AD-TL-6500/P24

AD-TL-6500/P40



Rodzaj sterowania: IR
Control type: IR

Symbol	EAN	Zastosowanie	Sterowanie (ilość przycisków)	Zasięg komunikacji	Częstotliwość transmisji	Zakres napięcia wejściowego-wyjściowego	Ilość kanałów koloru	Natężenie prądu/kanał	Maks. moc taśmy	Wymiary sterownika [mm]	Wymiary pilota [mm]
Product no.		Application	Controls (number of buttons)	Communication range	Transmission frequency	Input-Output voltage range	Number of colour channels	Current per channel	Max. Led strip power	Controller dimensions [mm]	Remote control dimensions [mm]
AD-TL-6500/P11	5908254842375	Taśmy LED mono mono LED strips	11	15m	433,92 mHz	5-24V	1	6A	12V 72W	42 / 12 / 3	86 / 40 / 7
AD-TL-6500/P17	5908254842368	Taśmy LED RGB RGB LED strips	17	15m	433,92 mHz	5-24V	3	2A	12V 72W	42 / 12 / 3	86 / 40 / 7
AD-TL-6500/P24	5908254842351	Taśmy LED RGB RGB LED strips	24	5-8m	38 kHz	5-24V	3	2A	12V 72W	42 / 12 / 3	85 / 51 / 5
AD-TL-6500/P40	5908254842382	Taśmy LED RGBW RGBW LED strips	40	5-8m	38 kHz	12-24V	4	2A	12V 96W	42 / 12 / 3	124 / 55 / 7

Akcesoria do taśm LED

Accessories for LED strips

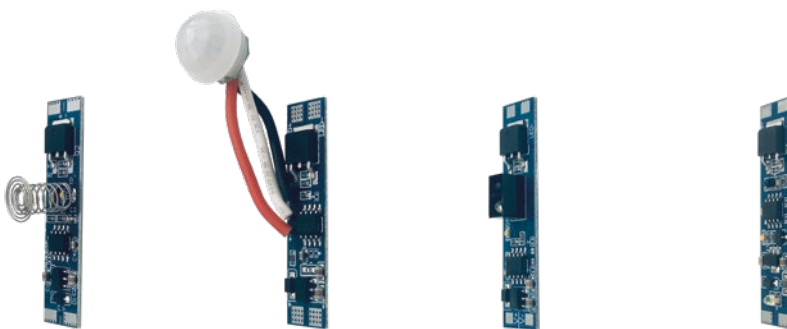

AD-TL-6497/T-S

AD-TL-6497/S-R

AD-TL-6497/DIMM

AD-TL-6497/P-S

Symbol	EAN	Typ włącznika	Sposób detekcji	Napięcie zasilania	Maks. moc	Maks. prąd	Współpracuje ze ściemniaczem	Sygnalizacja pracy	Wymiary (szer./wys./gł.) [mm]
Product no.		Type of switch	Detection type	Nominal voltage	Max. power	Max. current	Suitable for dimmer	Operation diode	Dimensions (W/H/D) [mm]
AD-TL-6497/T-S	5908254842115	Dotykowy Touch	dotyk touch	5-24V	5V-40W, 12V-96W, 24V-120W	8A	tak / yes	tak / yes	10 / 48 / 1
AD-TL-6497/S-R	5908254842122	Czujnik PIR PIR motion sensor	podczerwień infrared	5-24V	5V-40W, 12V-96W, 24V-120W	8A	-	-	10 / 43 / 1,5
AD-TL-6497/DIMM	5908254842139	Bezdotykowy Touchless	podczerwień infrared	5-24V	5V-40W, 12V-96W, 24V-120W	8A	tak / yes	tak / yes	10 / 48 / 1
AD-TL-6497/P-S	5908254842146	Zbliżeniowy Proximity	podczerwień infrared	5-24V	5V-40W, 12V-96W, 24V-120W	8A	tak / yes	tak / yes	10 / 48 / 1



Złączki LED

LED connectors



AD-TL-6499/Z



AD-TL-6499/Z/RGB



AD-TL-6499/Z/RGBW



AD-TL-6499/Z-P



AD-TL-6499/Z-P/RGB



AD-TL-6499/Z-P/RGBW



AD-TL-6499/Z-P-Z



AD-TL-6499/Z-P-Z/RGB



AD-TL-6499/Z-P-Z/RGBW

Symbol Product no.	EAN	Zastosowanie Application	Typ Type	Napięcie zasilania Nominal voltage	Ilość pinów Number of pins	Maks. prąd Max. current	Zastosowanie do taśm o szerokości Compatible with LED strips - width	Wymiary (szer./wys./gł.) [mm] Dimensions (W/H/D) [mm]	Długość przewodu Cable length
AD-TL-6499/Z	5908254842184	Taśmy LED mono Mono LED strips	Szybkozłączka Quick connector	0-48V	2	1,28A	8mm	12 / 16 / 5	-
AD-TL-6499/Z/RGB	5908254842191	Taśmy LED RGB RGB LED strips	Szybkozłączka Quick connector	0-48V	4	1,28A	10mm	15 / 16 / 5	-
AD-TL-6499/Z/RGBW	5908254842207	Taśmy LED RGBW RGBW LED strips	Szybkozłączka Quick connector	0-48V	5	1,28A	12mm	16 / 16 / 5	-
AD-TL-6499/Z-P	5908254842214	Taśmy LED mono Mono LED strips	Szybkozłączka jednostronna z przewodem One-sided LED connector with cable	0-48V	2	1,28A	8mm	12 / 160 / 5	150mm
AD-TL-6499/Z-P/RGB	5908254842221	Taśmy LED RGB RGB LED strips	Szybkozłączka jednostronna z przewodem One-sided LED connector with cable	0-48V	4	1,28A	10mm	15 / 160 / 5	150mm
AD-TL-6499/Z-P/RGBW	5908254842238	Taśmy LED RGBW RGBW LED strips	Szybkozłączka jednostronna z przewodem One-sided LED connector with cable	0-48V	5	1,28A	12mm	16 / 160 / 5	150mm
AD-TL-6499/Z-P-Z	5908254842245	Taśmy LED mono Mono LED strips	Szybkozłączka dwustronna z przewodem Ouble-sided LED connector with cable	0-48V	2	1,28A	8mm	12 / 170 / 5	150mm
AD-TL-6499/Z-P-Z/RGB	5908254842252	Taśmy LED RGB RGB LED strips	Szybkozłączka dwustronna z przewodem Ouble-sided LED connector with cable	0-48V	4	1,28A	10mm	15 / 170 / 5	150mm
AD-TL-6499/Z-P-Z/RGBW	5908254842269	Taśmy LED RGBW RGBW LED strips	Szybkozłączka dwustronna z przewodem Ouble-sided LED connector with cable	0-48V	5	1,28A	12mm	16 / 170 / 5	150mm

Złączki LED

LED connectors

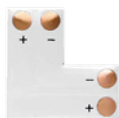

AD-TL-6499/Z/L



AD-TL-6499/Z/L/RGB



AD-TL-6499/Z/L/RGBW

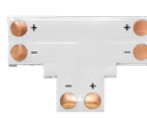

AD-TL-6499/Z/T



AD-TL-6499/Z/T/RGB



AD-TL-6499/Z/T/RGBW

Symbol Product no.	EAN	Zastosowanie Application	Typ Type	Napięcie zasilania Nominal voltage	Ilość pinów Number of pins	Maks. prąd Max. current	Zastosowanie do taśm o szerokości Compatible with LED strips - width	Wymiary (szer./wys./gł.) [mm] Dimensions (W/H/D) [mm]
AD-TL-6499/Z/L	5908254842290	Taśmy LED mono mono LED strips	Złączka kątowna L Angle connector L	0-48V	2	1,28A	8mm	16 / 16 / 0,2
AD-TL-6499/Z/L/RGB	5908254842306	Taśmy LED RGB RGB LED strips	Złączka kątowna L Angle connector L	0-48V	4	1,28A	10mm	20 / 20 / 0,2
AD-TL-6499/Z/L/RGBW	5908254842313	Taśmy LED RGBW RGBW LED strips	Złączka kątowna L Angle connector L	0-48V	5	1,28A	12mm	24 / 24 / 0,2
AD-TL-6499/Z/T	5908254842320	Taśmy LED mono mono LED strips	Złączka trójkąt T T type connector	0-48V	2	1,28A	8mm	24 / 16 / 0,2
AD-TL-6499/Z/T/RGB	5908254842337	Taśmy LED RGB RGB LED strips	Złączka trójkąt T T type connector	0-48V	4	1,28A	10mm	30 / 20 / 0,2
AD-TL-6499/Z/T/RGBW	5908254842344	Taśmy LED RGBW RGBW LED strips	Złączka trójkąt T T type connector	0-48V	5	1,28A	12mm	28 / 20 / 0,2

Przewody do taśm LED

Cable for LED strips



AD-TL-6498/25M



AD-TL-6498/RGB/25M



AD-TL-6498/RGBW/25M

Symbol Product no.	EAN	Zastosowanie Application	Przekrój przewodu Conductor cross section	Ilość żył Number of wires	Materiał izolacji Insulation material	Materiał przewodnika Conductor material	Długość całkowita Total length
AD-TL-6498/25M	5908254842153	Taśmy LED mono Mono LED strips	35mm ²	2	PVC	Miedź Copper	25m
AD-TL-6498/RGB/25M	5908254842160	Taśmy LED RGB RGB LED strips	35mm ²	4	PVC	Miedź Copper	25m
AD-TL-6498/RGBW/25M	5908254842177	Taśmy LED RGBW RGBW LED strips	35mm ²	5	PVC	Miedź Copper	25m

Pozostałe akcesoria

Other accessories



AD-TL-6499/W-Z



AD-TL-6499/G-Z

Symbol Product no.	EAN	Zastosowanie Application	Typ Type	Napięcie zasilania Nominal voltage	Ilość pinów Number of pins	Maks. prąd Max. current	Zastosowanie do taśm o szerokości Compatible with LED strips - width	Wymiary (szer./wys./gł.) [mm] Dimensions (W/H/D) [mm]
AD-TL-6499/W-Z	5908254842276	Taśmy LED mono Mono LED strips	Wtyk DC męski DC male plug	0-48V	2	1,28A	8mm 10mm	13 / 35 / 11
AD-TL-6499/G-Z	5908254842283	Taśmy LED mono Mono LED strips	Gniazdo DC żeńskie DC female socket	0-48V	2	1,28A	8mm 10mm	13 / 37 / 11

Profile aluminiowe do taśm LED

Aluminium profiles for LED strips

Adviti
LIGHTING SOLUTIONS





AD-LP-6502G/2M
AD-LP-6502G/2M/50



AD-LP-6502B/2M
AD-LP-6502B/2M/50

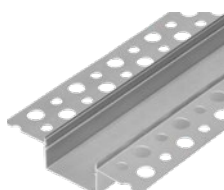

AD-LP-6503G/2M
AD-LP-6503G/2M/50

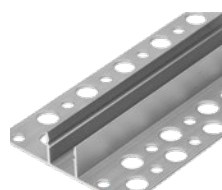

AD-LP-6504G/2M
AD-LP-6504G/2M/50



AD-LP-6505G/2M
AD-LP-6505G/2M/50



AD-LP-6505B/2M
AD-LP-6505B/2M/50



AD-LP-6506G/2M
AD-LP-6506G/2M/50



AD-LP-6506B/2M
AD-LP-6506B/2M/50

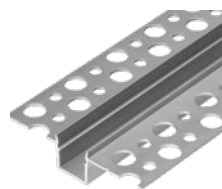

AD-LP-6507G/2M
AD-LP-6507G/2M/50

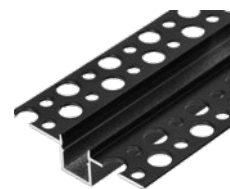

AD-LP-6507B/2M
AD-LP-6507B/2M/50













Symbol	EAN	Model	Inne cechy	Montaż	Materiał	Kolor	Wymiary 1 szt. (szer./wys./gł.) [mm]	Szerokość szczeliny [mm]	Szerokość otworu [mm]	Ilość w opakowaniu [szt]
Product no.			Other features	Installation	Material	Color	Dimensions 1 pc. (W/H/D) [mm]	Slit width[mm]	Hole width [mm]	Quantity per pack [pcs]
AD-LP-6502G/2M	5904988907496	Profil pojedynczy Single profile	Kątowny Angled	Natynkowy Surface	Aluminium	Aluminium	15,8 / 15,8 / 2000	10	-	1
AD-LP-6502G/2M/50	5904988907502	Profil pojedynczy Single profile	Kątowny Angled	Natynkowy Surface	Aluminium	Aluminium	15,8 / 15,8 / 2000	10	-	50
AD-LP-6502B/2M	5904988907519	Profil pojedynczy Single profile	Kątowny Angled	Natynkowy Surface	Aluminium	Czarny Black	15,8 / 15,8 / 2000	10	-	1
AD-LP-6502B/2M/50	5904988907526	Profil pojedynczy Single profile	Kątowny Angled	Natynkowy Surface	Aluminium	Czarny Black	15,8 / 15,8 / 2000	10	-	50
AD-LP-6503G/2M	5904988907656	Profil podwójny double profile	-	Podtynkowy Flush-mounted	Aluminium	Aluminium	57,89 / 11,9 / 2000	23,63	-	1
AD-LP-6503G/2M/50	5904988907663	Profil podwójny double profile	-	Podtynkowy Flush-mounted	Aluminium	Aluminium	57,89 / 11,9 / 2000	23,63	-	50
AD-LP-6504G/2M	5904988907755	Profil pojedynczy Single profile	-	Podtynkowy Flush-mounted	Aluminium	Aluminium	52,8 / 13 / 2000	13	-	1
AD-LP-6504G/2M/50	5904988907762	Profil pojedynczy Single profile	-	Podtynkowy Flush-mounted	Aluminium	Aluminium	52,8 / 13 / 2000	13	-	50
AD-LP-6505G/2M	5904988907854	Profil pojedynczy Single profile	-	Podtynkowy Flush-mounted	Aluminium	Aluminium	24,5 / 6,85 / 2000	12	17	1
AD-LP-6505G/2M/50	5904988907861	Profil pojedynczy Single profile	-	Podtynkowy Flush-mounted	Aluminium	Aluminium	24,5 / 6,85 / 2000	12	17	50
AD-LP-6505B/2M	5904988907878	Profil pojedynczy Single profile	-	Podtynkowy Flush-mounted	Aluminium	Czarny Black	24,5 / 6,85 / 2000	12	17	1
AD-LP-6505B/2M/50	5904988907885	Profil pojedynczy Single profile	-	Podtynkowy Flush-mounted	Aluminium	Czarny Black	24,5 / 6,85 / 2000	12	17	50
AD-LP-6506G/2M	5904988908011	Profil pojedynczy Single profile	-	Natynkowy Surface	Aluminium	Aluminium	17 / 7 / 2000	12	17	1
AD-LP-6506G/2M/50	5904988908028	Profil pojedynczy Single profile	-	Natynkowy Surface	Aluminium	Aluminium	17 / 7 / 2000	12	17	50
AD-LP-6506B/2M	5904988908035	Profil pojedynczy Single profile	-	Natynkowy Surface	Aluminium	Czarny Black	17 / 7 / 2000	12	17	1
AD-LP-6506B/2M/50	5904988908042	Profil pojedynczy Single profile	-	Natynkowy Surface	Aluminium	Czarny Black	17 / 7 / 2000	12	17	50
AD-LP-6507G/2M	5904988908172	Profil pojedynczy Single profile	-	Podtynkowy Flush-mounted	Aluminium	Aluminium	55 / 13 / 2000	10,9	13	1
AD-LP-6507G/2M/50	5904988908189	Profil pojedynczy Single profile	-	Podtynkowy Flush-mounted	Aluminium	Aluminium	55 / 13 / 2000	10,9	13	50
AD-LP-6507B/2M	5904988908196	Profil pojedynczy Single profile	-	Podtynkowy Flush-mounted	Aluminium	Czarny Black	55 / 13 / 2000	10,9	13	1
AD-LP-6507B/2M/50	5904988908202	Profil pojedynczy Single profile	-	Podtynkowy Flush-mounted	Aluminium	Czarny Black	55 / 13 / 2000	10,9	13	50

Klosze do profili aluminiowych

Aluminium profiles covers

Adviti
LIGHTING SOLUTIONS

Symbol	EAN	Zastosowanie	Kolor klosza	Kształt klosza	Materiał	Wymiary 1 szt. (szer./wys./gł.) [mm]	Ilość w opakowaniu [szt]
Product no.		Application	Cover color	Cover shape	Material	Dimensions 1 pc. (W/H/D) [mm]	Quantity per pack [pcs]
 AD-LP-6502PP/2M	5904988907533	Do profili z serii AD-LP-6502 For AD-LP-6502 profile series	Bezbarwny Colourless	Wypukły Convex	Poliwęglan Polycarbonate	20 / 5,4 / 2000	1
AD-LP-6502PP/2M/50	5904988907540	Do profili z serii AD-LP-6502 For AD-LP-6502 profile series	Bezbarwny Colourless	Wypukły Convex	Poliwęglan Polycarbonate	20 / 5,4 / 2000	50
 AD-LP-6502PM/2M	5904988907557	Do profili z serii AD-LP-6502 For AD-LP-6502 profile series	Mleczny Milky	Wypukły Convex	Poliwęglan Polycarbonate	20 / 5,4 / 2000	1
AD-LP-6502PM/2M/50	5904988907564	Do profili z serii AD-LP-6502 For AD-LP-6502 profile series	Mleczny Milky	Wypukły Convex	Poliwęglan Polycarbonate	20 / 5,4 / 2000	50
 AD-LP-6502PB/2M	5904988907571	Do profili z serii AD-LP-6502 For AD-LP-6502 profile series	Czarny Black	Wypukły Convex	Poliwęglan Polycarbonate	20 / 5,4 / 2000	1
AD-LP-6502PB/2M/50	5904988907588	Do profili z serii AD-LP-6502 For AD-LP-6502 profile series	Czarny Black	Wypukły Convex	Poliwęglan Polycarbonate	20 / 5,4 / 2000	50
 AD-LP-6503PP/2M	5904988907670	Do profili z serii AD-LP-6503 For AD-LP-6503 profile series	Bezbarwny Colourless	Prostokątny Rectangular	Poliwęglan Polycarbonate	22 / 3,8 / 2000	1
AD-LP-6503PP/2M/50	5904988907687	Do profili z serii AD-LP-6503 For AD-LP-6503 profile series	Bezbarwny Colourless	Prostokątny Rectangular	Poliwęglan Polycarbonate	22 / 3,8 / 2000	50
 AD-LP-6503PM/2M	5904988907694	Do profili z serii AD-LP-6503 For AD-LP-6503 profile series	Mleczny Milky	Prostokątny Rectangular	Poliwęglan Polycarbonate	22 / 3,8 / 2000	1
AD-LP-6503PM/2M/50	5904988907700	Do profili z serii AD-LP-6503 For AD-LP-6503 profile series	Mleczny Milky	Prostokątny Rectangular	Poliwęglan Polycarbonate	22 / 3,8 / 2000	50
 AD-LP-6503PB/2M	5904988907717	Do profili z serii AD-LP-6503 For AD-LP-6503 profile series	Czarny Black	Prostokątny Rectangular	Poliwęglan Polycarbonate	22 / 3,8 / 2000	1
AD-LP-6503PB/2M/50	5904988907724	Do profili z serii AD-LP-6503 For AD-LP-6503 profile series	Czarny Black	Prostokątny Rectangular	Poliwęglan Polycarbonate	22 / 3,8 / 2000	50
 AD-LP-6504PP/2M	5904988907779	Do profili z serii AD-LP-6504 For AD-LP-6504 profile series	Bezbarwny Colourless	Prostokątny Rectangular	Poliwęglan Polycarbonate	11 / 4,4 / 2000	1
AD-LP-6504PP/2M/50	5904988907786	Do profili z serii AD-LP-6504 For AD-LP-6504 profile series	Bezbarwny Colourless	Prostokątny Rectangular	Poliwęglan Polycarbonate	11 / 4,4 / 2000	50
 AD-LP-6504PM/2M	5904988907793	Do profili z serii AD-LP-6504 For AD-LP-6504 profile series	Mleczny Milky	Prostokątny Rectangular	Poliwęglan Polycarbonate	11 / 4,4 / 2000	1
AD-LP-6504PM/2M/50	5904988907809	Do profili z serii AD-LP-6504 For AD-LP-6504 profile series	Mleczny Milky	Prostokątny Rectangular	Poliwęglan Polycarbonate	11 / 4,4 / 2000	50
 AD-LP-6504PB/2M	5904988907816	Do profili z serii AD-LP-6504 For AD-LP-6504 profile series	Czarny Black	Prostokątny Rectangular	Poliwęglan Polycarbonate	11 / 4,4 / 2000	1
AD-LP-6504PB/2M/50	5904988907823	Do profili z serii AD-LP-6504 For AD-LP-6504 profile series	Czarny Black	Prostokątny Rectangular	Poliwęglan Polycarbonate	11 / 4,4 / 2000	50
 AD-LP-6505PP/2M	5904988907892	Do profili z serii AD-LP-6505 For AD-LP-6505 profile series	Bezbarwny Colourless	Prostokątny Rectangular	Poliwęglan Polycarbonate	14 / 4 / 2000	1
AD-LP-6505PP/2M/50	5904988907908	Do profili z serii AD-LP-6505 For AD-LP-6505 profile series	Bezbarwny Colourless	Prostokątny Rectangular	Poliwęglan Polycarbonate	14 / 4 / 2000	50
 AD-LP-6505PM/2M	5904988907915	Do profili z serii AD-LP-6505 For AD-LP-6505 profile series	Mleczny Milky	Prostokątny Rectangular	Poliwęglan Polycarbonate	14 / 4 / 2000	1
AD-LP-6505PM/2M/50	5904988907922	Do profili z serii AD-LP-6505 For AD-LP-6505 profile series	Mleczny Milky	Prostokątny Rectangular	Poliwęglan Polycarbonate	14 / 4 / 2000	50
 AD-LP-6505PB/2M	5904988907939	Do profili z serii AD-LP-6505 For AD-LP-6505 profile series	Czarny Black	Prostokątny Rectangular	Poliwęglan Polycarbonate	14 / 4 / 2000	1
AD-LP-6505PB/2M/50	5904988907946	Do profili z serii AD-LP-6505 For AD-LP-6505 profile series	Czarny Black	Prostokątny Rectangular	Poliwęglan Polycarbonate	14 / 4 / 2000	50
 AD-LP-6506PP/2M	5904988908059	Do profili z serii AD-LP-6506 For AD-LP-6506 profile series	Bezbarwny Colourless	Prostokątny Rectangular	Poliwęglan Polycarbonate	14 / 4 / 2000	1
AD-LP-6506PP/2M/50	5904988908066	Do profili z serii AD-LP-6506 For AD-LP-6506 profile series	Bezbarwny Colourless	Prostokątny Rectangular	Poliwęglan Polycarbonate	14 / 4 / 2000	50
 AD-LP-6506PM/2M	5904988908073	Do profili z serii AD-LP-6506 For AD-LP-6506 profile series	Mleczny Milky	Prostokątny Rectangular	Poliwęglan Polycarbonate	14 / 4 / 2000	1
AD-LP-6506PM/2M/50	5904988908080	Do profili z serii AD-LP-6506 For AD-LP-6506 profile series	Mleczny Milky	Prostokątny Rectangular	Poliwęglan Polycarbonate	14 / 4 / 2000	50
 AD-LP-6506PB/2M	5904988908097	Do profili z serii AD-LP-6506 For AD-LP-6506 profile series	Czarny Black	Prostokątny Rectangular	Poliwęglan Polycarbonate	14 / 4 / 2000	1
AD-LP-6506PB/2M/50	5904988908103	Do profili z serii AD-LP-6506 For AD-LP-6506 profile series	Czarny Black	Prostokątny Rectangular	Poliwęglan Polycarbonate	14 / 4 / 2000	50
 AD-LP-6507PP/2M	5904988908219	Do profili z serii AD-LP-6507 For AD-LP-6507 profile series	Bezbarwny Colourless	Prostokątny Rectangular	Poliwęglan Polycarbonate	11 / 4,4 / 2000	1
AD-LP-6507PP/2M/50	5904988908226	Do profili z serii AD-LP-6507 For AD-LP-6507 profile series	Bezbarwny Colourless	Prostokątny Rectangular	Poliwęglan Polycarbonate	11 / 4,4 / 2000	50
 AD-LP-6507PM/2M	5904988908233	Do profili z serii AD-LP-6507 For AD-LP-6507 profile series	Mleczny Milky	Prostokątny Rectangular	Poliwęglan Polycarbonate	11 / 4,4 / 2000	1
AD-LP-6507PM/2M/50	5904988908240	Do profili z serii AD-LP-6507 For AD-LP-6507 profile series	Mleczny Milky	Prostokątny Rectangular	Poliwęglan Polycarbonate	11 / 4,4 / 2000	50
 AD-LP-6507PB/2M	5904988908257	Do profili z serii AD-LP-6507 For AD-LP-6507 profile series	Czarny Black	Prostokątny Rectangular	Poliwęglan Polycarbonate	11 / 4,4 / 2000	1
AD-LP-6507PB/2M/50	5904988908264	Do profili z serii AD-LP-6507 For AD-LP-6507 profile series	Czarny Black	Prostokątny Rectangular	Poliwęglan Polycarbonate	11 / 4,4 / 2000	50

	Symbol Product no.	EAN	Typ Type	Zastosowanie Application	Kolor Color	Materiał Material	Ilość w opakowaniu [szt] Quantity per pack [pcs]
	AD-LP-6502WEC	5904988907595	Zaślepka End capp	Do profili z serii AD-LP-6502 For AD-LP-6502 profile series	Biały White	Tworzywo sztuczne Plastic	1
	AD-LP-6502WEC/50	5904988907601	Zaślepka End capp	Do profili z serii AD-LP-6502 For AD-LP-6502 profile series	Biały White	Tworzywo sztuczne Plastic	50
	AD-LP-6502BEC	5904988907618	Zaślepka End capp	Do profili z serii AD-LP-6502 For AD-LP-6502 profile series	Czarny Black	Tworzywo sztuczne Plastic	1
	AD-LP-6502BEC/50	5904988907625	Zaślepka End capp	Do profili z serii AD-LP-6502 For AD-LP-6502 profile series	Czarny Black	Tworzywo sztuczne Plastic	50
	AD-LP-6503GEC	5904988907731	Zaślepka End capp	Do profili z serii AD-LP-6503 For AD-LP-6503 profile series	Szary Grey	Tworzywo sztuczne Plastic	1
	AD-LP-6503GEC/50	5904988907748	Zaślepka End capp	Do profili z serii AD-LP-6503 For AD-LP-6503 profile series	Szary Grey	Tworzywo sztuczne Plastic	50
	AD-LP-6504GEC	5904988907830	Zaślepka End capp	Do profili z serii AD-LP-6504 For AD-LP-6504 profile series	Szary Grey	Tworzywo sztuczne Plastic	1
	AD-LP-6504GEC/50	5904988907847	Zaślepka End capp	Do profili z serii AD-LP-6504 For AD-LP-6504 profile series	Szary Grey	Tworzywo sztuczne Plastic	50
	AD-LP-6505WEC	5904988907953	Zaślepka End capp	Do profili z serii AD-LP-6505 For AD-LP-6505 profile series	Biały White	Tworzywo sztuczne Plastic	1
	AD-LP-6505WEC/50	5904988907960	Zaślepka End capp	Do profili z serii AD-LP-6505 For AD-LP-6505 profile series	Biały White	Tworzywo sztuczne Plastic	50
	AD-LP-6505BEC	5904988907977	Zaślepka End capp	Do profili z serii AD-LP-6505 For AD-LP-6505 profile series	Czarny Black	Tworzywo sztuczne Plastic	1
	AD-LP-6505BEC/50	5904988907984	Zaślepka End capp	Do profili z serii AD-LP-6505 For AD-LP-6505 profile series	Czarny Black	Tworzywo sztuczne Plastic	50
	AD-LP-6506WEC	5904988908110	Zaślepka End capp	Do profili z serii AD-LP-6506 For AD-LP-6506 profile series	Biały White	Tworzywo sztuczne Plastic	1
	AD-LP-6506WEC/50	5904988908127	Zaślepka End capp	Do profili z serii AD-LP-6506 For AD-LP-6506 profile series	Biały White	Tworzywo sztuczne Plastic	50
	AD-LP-6506BEC	5904988908134	Zaślepka End capp	Do profili z serii AD-LP-6506 For AD-LP-6506 profile series	Czarny Black	Tworzywo sztuczne Plastic	1
	AD-LP-6506BEC/50	5904988908141	Zaślepka End capp	Do profili z serii AD-LP-6506 For AD-LP-6506 profile series	Czarny Black	Tworzywo sztuczne Plastic	50
	AD-LP-6507GEC	5904988908271	Zaślepka End capp	Do profili z serii AD-LP-6507 For AD-LP-6507 profile series	Szary Grey	Tworzywo sztuczne Plastic	1
	AD-LP-6507GEC/50	5904988908288	Zaślepka End capp	Do profili z serii AD-LP-6507 For AD-LP-6507 profile series	Szary Grey	Tworzywo sztuczne Plastic	50
	AD-LP-6507BEC	5904988908295	Zaślepka End capp	Do profili z serii AD-LP-6507 For AD-LP-6507 profile series	Czarny Black	Tworzywo sztuczne Plastic	1
	AD-LP-6507BEC/50	5904988908301	Zaślepka End capp	Do profili z serii AD-LP-6507 For AD-LP-6507 profile series	Czarny Black	Tworzywo sztuczne Plastic	50
	AD-LP-6502MC	5904988907632	Klips montażowy Mounting clip	Do profili z serii AD-LP-6502 For AD-LP-6502 profile series	-	Stal Steel	1
	AD-LP-6502MC/50	5904988907649	Klips montażowy Mounting clip	Do profili z serii AD-LP-6502 For AD-LP-6502 profile series	-	Stal Steel	50
	AD-LP-6506MC	5904988908158	Klips montażowy Mounting clip	Do profili z serii AD-LP-6505, AD-LP-6506 For AD-LP-6505, AD-LP-6506 profile series	-	Stal Steel	1
	AD-LP-6506MC/50	5904988908165	Klips montażowy Mounting clip	Do profili z serii AD-LP-6505, AD-LP-6506 For AD-LP-6505, AD-LP-6506 profile series	-	Stal Steel	50









Adaptery

Light source adapters

ViRONE
simple made easy.



Oprawki termoplastyczne

Thermoplastic lamp holders

	Symbol	EAN	Prąd znamionowy	Trzonek	Rodzaj przyłącza	Kolor	Ilość w opakowaniu [szt]	Inne
	Product no.		Rated current	Base/holder	Connection type	Color	Quantity per pack [pcs]	Others
	LH/E27-1/W	5908254815560	4A	E27	Kostka przyłączeniowa Connection block	Biały White	1	-
	LH/E27-1/W/40	5908254814372	4A	E27	Kostka przyłączeniowa Connection block	Biały White	40	-
	LH/E27-1/B	5908254815577	4A	E27	Kostka przyłączeniowa Connection block	Czarny Black	1	-
	LH/E27-1/B/40	5908254814389	4A	E27	Kostka przyłączeniowa Connection block	Czarny Black	40	-
	LH/E14-1/W	5908254815607	4A	E14	Kostka przyłączeniowa Connection block	Biały White	1	-
	LH/E14-1/W/40	5908254814419	4A	E14	Kostka przyłączeniowa Connection block	Biały White	40	-
	LH/E14-1/B	5908254815614	4A	E14	Kostka przyłączeniowa Connection block	Czarny Black	1	-
	LH/E14-1/B/40	5908254814426	4A	E14	Kostka przyłączeniowa Connection block	Czarny Black	40	-
	LH/E27-2/W	5908254815621	4A	E27	Kostka przyłączeniowa Connection block	Biały White	1	Z kołnierzem With flange
	LH/E27-2/W/40	5908254814433	4A	E27	Kostka przyłączeniowa Connection block	Biały White	40	Z kołnierzem With flange
	LH/E27-2/B	5908254815638	4A	E27	Kostka przyłączeniowa Connection block	Czarny Black	1	Z kołnierzem With flange
	LH/E27-2/B/40	5908254814440	4A	E27	Kostka przyłączeniowa Connection block	Czarny Black	40	Z kołnierzem With flange
	LH/E14-2/W	5908254815584	4A	E14	Kostka przyłączeniowa Connection block	Biały White	1	Z kołnierzem With flange
	LH/E14-2/W/40	5908254814396	4A	E14	Kostka przyłączeniowa Connection block	Biały White	40	Z kołnierzem With flange
	LH/E14-2/B	5908254815591	4A	E14	Kostka przyłączeniowa Connection block	Czarny Black	1	Z kołnierzem With flange
	LH/E14-2/B/40	5908254814402	4A	E14	Kostka przyłączeniowa Connection block	Czarny Black	40	Z kołnierzem With flange

Oprawki porcelanowe

Porcelain lamp holders

	Symbol	EAN	Prąd znamionowy	Trzonek	Rodzaj przyłącza	Kolor	Ilość w opakowaniu [szt]	Inne
	Product no.		Rated current	Base/holder	Connection type	Color	Quantity per pack [pcs]	Others
	LH/E27-3	5908254815645	4A	E27	Kostka przyłączeniowa Connection block	Szary Grey	1	-
	LH/E27-3/20	5908254814457	4A	E27	Kostka przyłączeniowa Connection block	Szary Grey	20	-
	LH/E27-4	5908254815652	4A	E27	Kostka przyłączeniowa Connection block	Szary Grey	1	Wspornik mocujący Mounting bracket
	LH/E27-4/20	5908254814464	4A	E27	Kostka przyłączeniowa Connection block	Szary Grey	20	Wspornik mocujący Mounting bracket



Oprawka ceramiczna

Ceramic fixture

	Symbol	EAN	Napięcie nominalne	Trzonek	Inne
	Product no.		Nominal voltage	Base/holder	Others
	LH/GZ10-1	5908254820632	230V~, 50Hz	GU10	Przewód o długości 15cm 15cm cable











Oprawki remontowe

Cord-grip lampholder

	Symbol Product no.	EAN	Napięcie nominalne Nominal voltage	Trzonek Base/holder	Rodzaj przyłącza Connection type	Kolor Color	Materiał Material	Ilość w opa- kowaniu [szt] Quantity per pack [pcs]
	LH/E27-20/W/PZ	5908254840647	230V~, 50Hz	E27	Kostka przyłączeniowa Connection block	Biały White	Tworzywo sztuczne Plastic	1
	LH/E27-20/W/PZ/50	5908254840654	230V~, 50Hz	E27	Kostka przyłączeniowa Connection block	Biały White	Tworzywo sztuczne Plastic	50
	LH/E27-20/B/PZ	5908254840623	230V~, 50Hz	E27	Kostka przyłączeniowa Connection block	Czarny Black	Tworzywo sztuczne Plastic	1
	LH/E27-20/B/PZ/50	5908254840630	230V~, 50Hz	E27	Kostka przyłączeniowa Connection block	Czarny Black	Tworzywo sztuczne Plastic	50
	LH/E27-27/W/PZ	5908254842658	230V~, 50Hz	E27	Kostka przyłączeniowa Connection block	Biały White	Tworzywo sztuczne Plastic	1
	LH/E27-27/B/PZ	5908254842665	230V~, 50Hz	E27	Kostka przyłączeniowa Connection block	Czarny Black	Tworzywo sztuczne Plastic	1

Adaptory do źródeł światła

Bulb holder adapters

	Symbol Product no.	EAN	Trzonek Base/holder
	LH/E14/E27-5	5908254818981	E14 / E27
	LH/E27/E14-6	5908254820649	E27 / E14
	LH/E27/GU10-13	5908254826702	E27 / GU10
	LH/E14/GU10-14	5908254827891	E14 / GU10
	LH/GU10/E27-23	5908254842498	GU10 / E27
	LH/E40/E27-28	5908254842924	E40 / E27
	LH/E27/2XE27-15	5908254828577	E27 / 2xE27
	LH/E27/2XE27-16	5908254828584	E27 / 2xE27
	LH/E27/3XE27-17	5908254828591	E27 / 3xE27
	LH/E27/3XE27-18	5908254828607	E27 / 3xE27
	LH/E27/4XE27-19	5908254828614	E27 / 4xE27



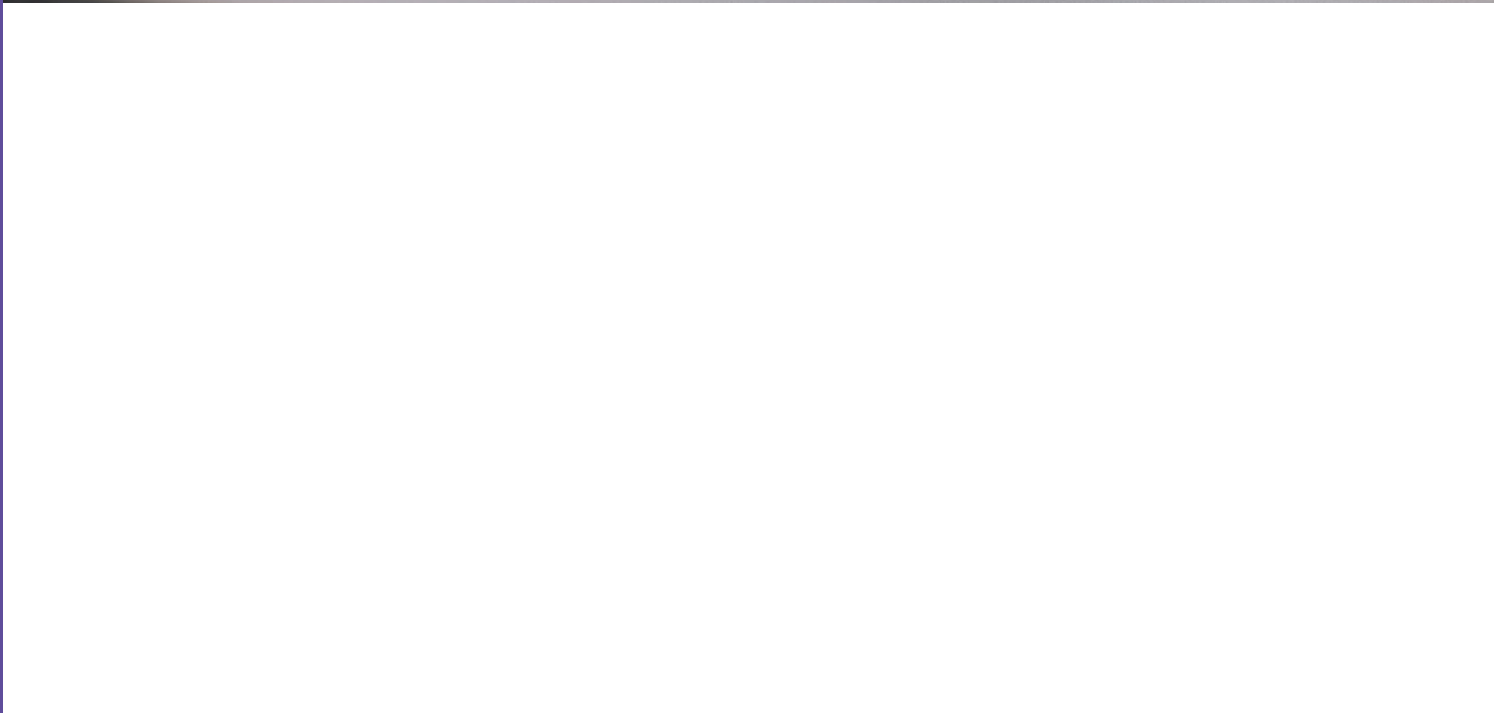
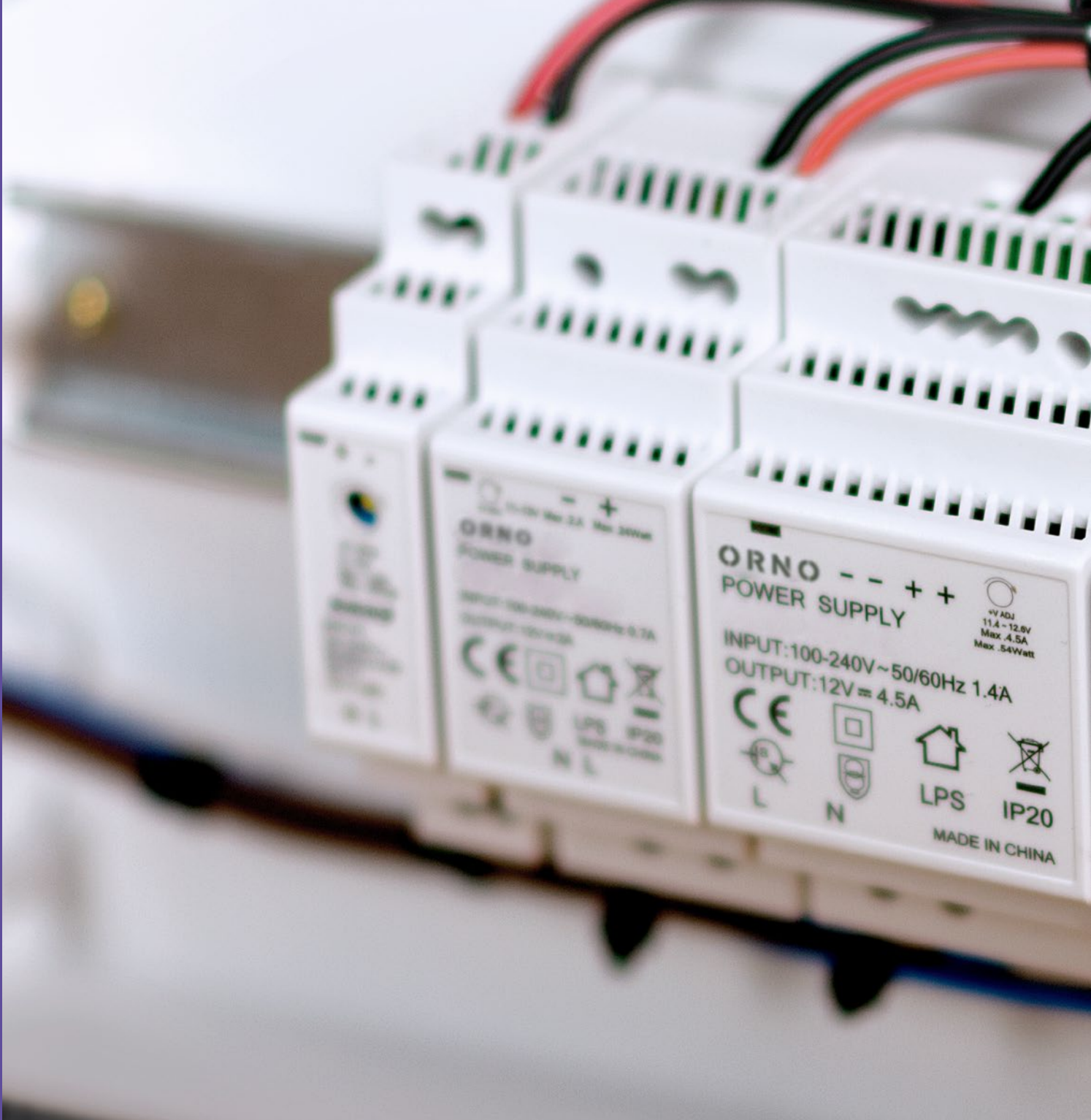

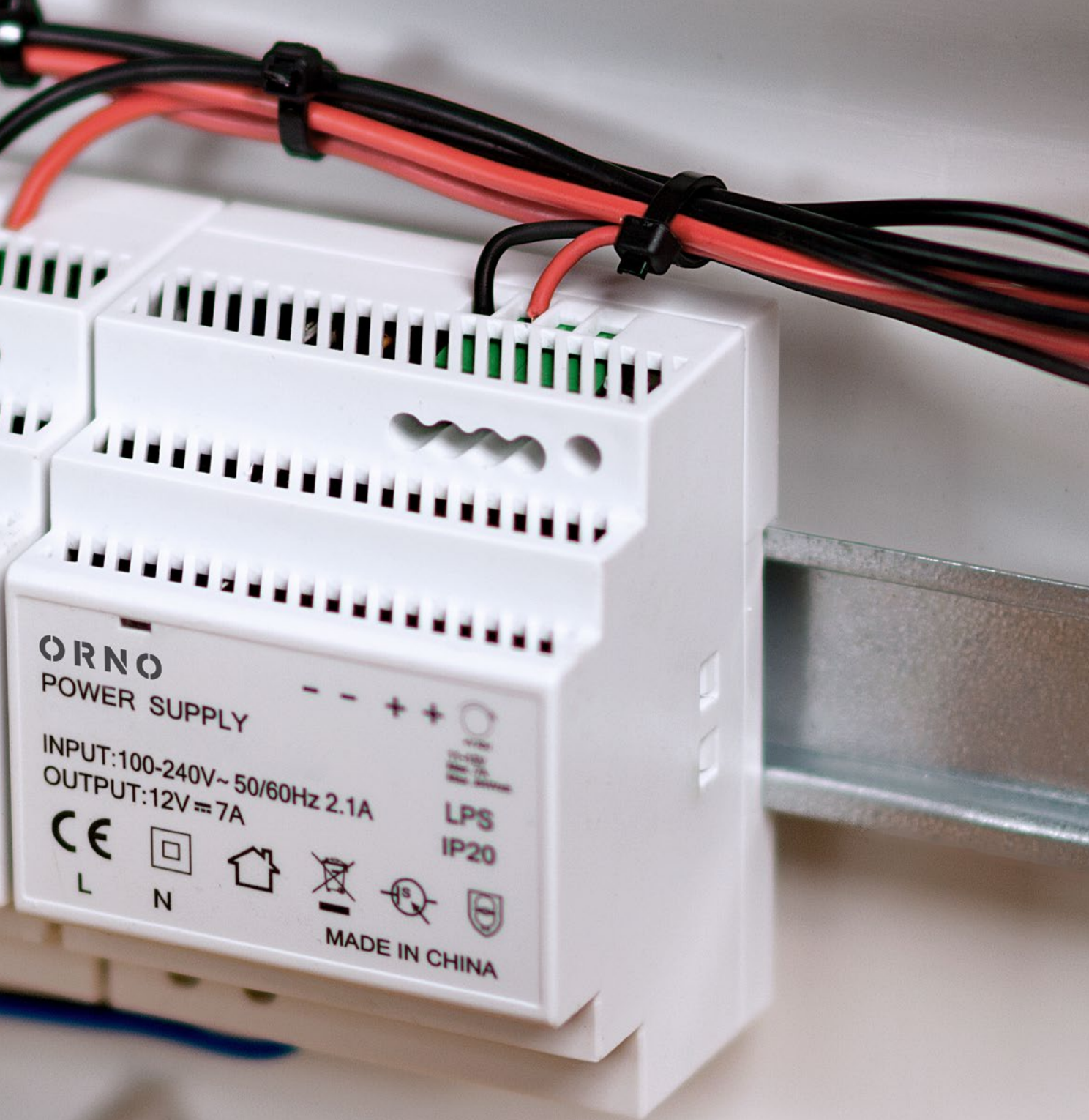

ORNO
POWER SUPPLY

INPUT: 100-240V~ 50/60Hz 2.1A
OUTPUT: 12V = 7A



L



N



MADE IN CHINA

LPS
IP20

Elektryka

Electricity

Nowości produktowe
New products

2023/2024

Aparatura modułowa

Modular apparatus

ORNO
FOR PROFESSIONALS



Liczniki

Energy meters



OR-WE-523



OR-WE-524



OR-WE-525







OR-WE-526

Model Product no.	OR-WE-523	OR-WE-524	OR-WE-525	OR-WE-526
EAN	5908254826146	5908254827839	5908254827846	5908254827853
Zgodność Conformity	MID 2014/32/EU	MID 2014/32/EU	MID 2014/32/EU	MID 2014/32/EU
Norma Standard	EN50470-1:2006, EN50470-3:2006	EN50470-1:2006, EN50470-3:2006	EN50470-1:2006, EN50470-3:2006	EN50470-1:2006, EN50470-3:2006
Napięcie znamionowe Rated voltage	230V~, 50Hz	230V~, 50Hz	230V~, 50Hz	230V~, 50Hz
Prąd min. (Imin) Min. current	0,25A	0,25A	0,25A	0,25A
Prąd bazowy (Ib) Base current	5A	5A	5A	5A
Prąd maks. (Imax) Max. current	80A	100A	100A	100A
Klasa dokładności Accuracy class	1	1	1	1
Wyświetlacz LCD LCD display	LCD 5+3 = 12345,123kWh	LCD 5+2 = 12345,12kWh	LCD 5+2 = 12345,12kWh	LCD 5+2 = 12345,12kWh
Temperatura robocza Working temperature	-40°C ~ +70°C	-25°C ~ +70°C	-25°C ~ +70°C	-25°C ~ +70°C
Zakres napięcia wyjścia impulsowego Pulse output voltage range	12-27VDC	12-27VDC	-	-
Prąd wyjścia impulsowego Pulse output current	≤ 27mA	≤ 27mA	-	-
Stopień ochrony Protection level	IP51	IP51	IP51	IP51
Maks. przekrój przewodów przyłączeniowych Max. cross-section of cables	35mm ²	25mm ²	25mm ²	25mm ²
Montaż Installation	na szynę DIN DIN rail TH-35	na szynę DIN DIN rail TH-35	na szynę DIN DIN rail TH-35	na szynę DIN DIN rail TH-35
Szerokość Width	2 moduły/modules 36mm	1 moduł/module 18mm	1 moduł/module 18mm	1 moduł/module 18mm
Stała licznika [imp/kWh] Meter constant	1000	1000	1000	1000
Wyjście impulsowe S0 Pulse output S0	✓	✓	-	-
Port IR	-	-	-	-
Protokół RS485, Modbus-RTU Protocol RS485, Modbus-RTU	✓	-	✓	✓
Podświetlenie Backlight	-	✓	✓	✓
Moc czynna Active power	✓	✓	✓	✓
Moc bierna Reactive power	✓	✓	✓	✓
Moc pobrana Forwarded power	✓	✓	✓	✓
Moc oddana Reversed power	✓	✓	✓	✓
Wielotaryfowość Multitariff	-	-	-	✓
Możliwość kasowania podlicznika Resetting sub-meter possibility	✓	✓	✓	✓
Podtrzymanie pamięcią Memory support	EEPROM	EEPROM	EEPROM	bateria litowa lithium battery

Zasilacze na szynę DIN

DIN rail power supply units



					
Model Product no.	OR-PSU-1642	OR-PSU-1643	OR-PSU-1644	OR-PSU-1645	OR-PSU-1666
EAN	5908254803833	5908254803840	5908254803857	5908254803864	5908254842559
Napięcie wyjścia Output voltage	12V DC	12V DC	12V DC	12V DC	12V DC
Prąd wyjścia Output current	1,25A	2A	4,5A	7A	11,3A
Moc Power	15W	24W	54W	84W	135,6W
Maks. prąd chwilowy Max. instant current	2,1A	2,4A	5A	9A	18A
Napięcie wejścia Input voltage	100-230V, 50-60Hz	100-230V, 50-60Hz	100-230V, 50-60Hz	100-230V, 50-60Hz	200-240V, 50-60Hz
Stopień ochrony Protection level	IP20	IP20	IP20	IP20	IP20
Montaż Installation	Na szynę DIN for DIN rail	Na szynę DIN for DIN rail	Na szynę DIN for DIN rail	Na szynę DIN for DIN rail	Na szynę DIN for DIN rail
Regulacja napięcia Voltage adjustment	✓	✓	✓	✓	✓
Zabezpieczenie przeciwzwarciowe Shortcircuit protection	✓	✓	✓	✓	✓
Zabezpieczenie prądowe Overload protection	✓	✓	✓	✓	✓
Zabezpieczenie napięciowe Voltage protection	✓	✓	✓	✓	✓
Efektywność [%] Efficiency [%]	85	85	85	85	85
Ilość modułów (18mm) Modules number (18mm)	1	2	3	4	6
Wymiary [mm] Dimensions [mm]	18 / 90 / 58	35 / 90 / 58	52,5 / 90 / 58	70 / 90 / 58	105 / 90 / 58

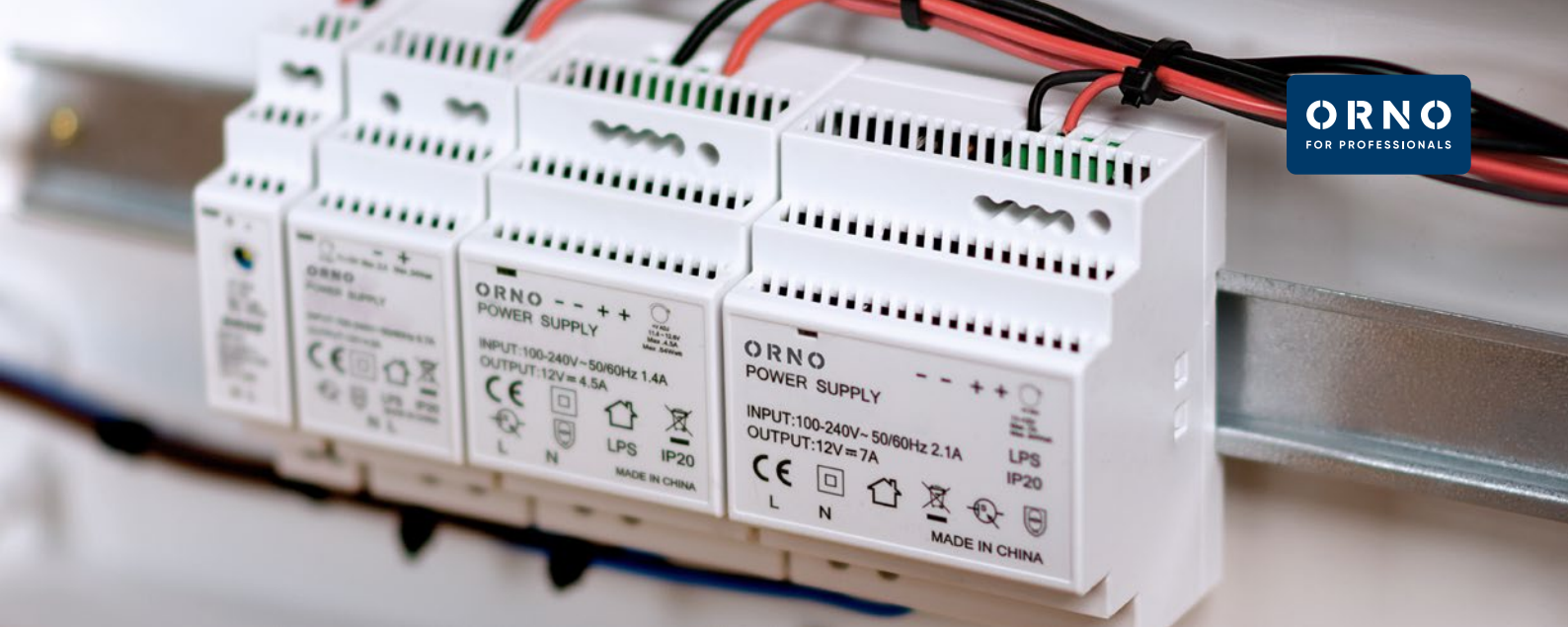

OR-PSU-1646	OR-PSU-1647	OR-PSU-1648	OR-PSU-1649	OR-PSU-1667
5908254803871	5908254803888	5908254803895	5908254803901	5908254842566
24V DC	24V DC	24V DC	24V DC	24V DC
0,63A	1A	2,5A	4A	6,25A
15W	24W	60W	96W	150W
0,8A	1,25A	3,4A	4,6A	10A
100-230V, 50-60Hz	100-230V, 50-60Hz	100-230V, 50-60Hz	100-230V, 50-60Hz	200-240V, 50-60Hz
IP20	IP20	IP20	IP20	IP20
Na szynę DIN for DIN rail	Na szynę DIN for DIN rail	Na szynę DIN for DIN rail	Na szynę DIN for DIN rail	Na szynę DIN for DIN rail
✓	✓	✓	✓	✓
✓	✓	✓	✓	✓
✓	✓	✓	✓	✓
✓	✓	✓	✓	✓
85	85	85	85	85
1	2	3	4	6
18 / 90 / 58	35 / 90 / 58	52,5 / 90 / 58	70 / 90 / 58	105 / 90 / 58

Zasilacze przemysłowe na szynę DIN

Industrial power supply units for DIN rail



OR-PSU-1660

OR-PSU-1661

OR-PSU-1662

OR-PSU-1663

OR-PSU-1664

Model Product no.	OR-PSU-1660	OR-PSU-1661	OR-PSU-1662	OR-PSU-1663	OR-PSU-1664
EAN	5908254824913	5908254824920	5908254824937	5908254824944	5908254824951
Napięcie wyjścia Output voltage	24V DC	24V DC	24V DC	24V DC	24V DC
Prąd wyjścia Output current	0,42A	1A	1,7A	2,5A	4A
Moc Power	10W	24W	40W	60W	96W
Maks. prąd chwilowy Max. instant current	0,63	1,5	2,55	3,75	6
Napięcie wejścia Input voltage	100-240V, 50-60Hz	100-240V, 50-60Hz	100-240V, 50-60Hz	100-240V, 50-60Hz	100-240V, 50-60Hz
Stopień ochrony Protection level	IP20	IP20	IP20	IP20	IP20
Montaż Installation	Na szynę DIN for DIN rail	Na szynę DIN for DIN rail	Na szynę DIN for DIN rail	Na szynę DIN for DIN rail	Na szynę DIN for DIN rail
Regulacja napięcia Voltage adjustment	✓	✓	✓	✓	✓
Zabezpieczenie przeciwzwarciowe Shortcircuit protection	✓	✓	✓	✓	✓
Zabezpieczenie prądowe Overload protection	✓	✓	✓	✓	✓
Zabezpieczenie napięciowe Voltage protection	✓	✓	✓	✓	✓
Efektywność [%] Efficiency [%]	81	81	88	88	86
Wymiary [mm] Dimensions [mm]	23x90x100	23x90x100	40x90x100	40x90x100	55x90x100
Inne Others	obudowa z tworzywa sztucznego plastic housing	obudowa z tworzywa sztucznego plastic housing	obudowa z tworzywa sztucznego plastic housing	obudowa z tworzywa sztucznego plastic housing	obudowa z tworzywa sztucznego plastic housing



OR-PSU-1665



OR-PSU-1656



OR-PSU-1657



OR-PSU-1658



OR-PSU-1659

OR-PSU-1665	OR-PSU-1656	OR-PSU-1657	OR-PSU-1658	OR-PSU-1659
5908254824968	5908254824807	5908254824814	5908254824890	5908254824906
12V DC	24V DC	24V DC	24V DC	24V DC
10A	3,2A	5A	10A	20A
120W	77W	120W	240W	480W
16	5	8	16	32
100-240V, 50-60Hz	100-240V, 50-60Hz	100-240V, 50-60Hz	100-240V, 50-60Hz	100-240V, 50-60Hz
IP20	IP20	IP20	IP20	IP20
Na szynę DIN for DIN rail	Na szynę DIN for DIN rail	Na szynę DIN for DIN rail	Na szynę DIN for DIN rail	Na szynę DIN for DIN rail
✓	✓	✓	✓	✓
✓	✓	✓	✓	✓
✓	✓	✓	✓	✓
✓	✓	✓	✓	✓
86	85,5	88	89	93
41x125x114	32x125x102	41x125x114	63x125x114	63x125x114
obudowa metalowa metal housing	obudowa metalowa metal housing	obudowa metalowa metal housing	obudowa metalowa metal housing	obudowa metalowa metal housing



OR-PI-456/24UC



OR-PI-456/230AC



OR-PI-457/1/230AC



OR-PI-457/1/UNI



OR-PI-457/3/UNI

Model	OR-PI-456		OR-PI-457		
	OR-PI-456/24UC	OR-PI-456/230AC	OR-PI-457/1/230AC	OR-PI-457/1/UNI	OR-PI-457/3/UNI
EAN	5904988904983	5904988904990	5904988905003	5904988905010	5904988905027
Napięcie sterowania Control voltage	24V AC/ DC	230V AC	230V AC	12-230V AC/DC	12-230V AC/DC
Ilość wyjść przełącznikowych Number of contacts	1P	1P	1P	1P	3P

Obwód wyjściowy – dane styków / Output circuit - contact data

Materiał styków Contact material	AgSnO ²	AgSnO ²	AgSnO ²	AgSnO ²	AgSnO ²
Maks. napięcie zestyków Max. switching voltage	300V AC	300V AC	300V AC / 300V DC	300V AC / 300V DC	300V AC / 300V DC
Obciążenie znamionowe Rated load	AC1: 16A/250V AC DC1: 16A/24V DC	AC1: 16A/250V AC DC1: 16A/24V DC	16 A / 250 V AC 16 A / 24 V DC	16 A / 250 V AC 16 A / 24 V DC	8 A / 250 V AC 8 A / 24 V DC
Maks. prąd załączania Max. inrush current	30A	30A	30A	30A	30A

Obwód wejściowy / Input circuit

Napięcie znamionowe Rated voltage	24V AC 50/60 Hz zaciski (-/+) A1, (+/-)A2	230 V 50/60 Hz, zaciski A1,A2	230V AC: 50/60Hz zaciski A1,A2	12...240 V AC: 50/60 Hz, zaciski (+)A1, (-)A2	12...240 V AC: 50/60 Hz, zaciski (+)A1, (-)A2
--------------------------------------	--	-------------------------------	-----------------------------------	--	--

Pozostałe dane / General data

Wymiary Dimensions	90 x 17,5 x 64,6 mm	90 x 17,5 x 64,6 mm	90 x 17,5 x 64,6 mm	90 x 17,5 x 64,6 mm	90 x 17,5 x 64,6 mm
Temperatura pracy Working temperature	20°C...+50 °C	20°C...+50 °C	20°C...+50 °C	20°C...+50 °C	20°C...+50 °C
Stopień ochrony obudowy Cover protection level	IP20	IP20	IP20	IP20	IP20
Maks. przekrój przewodów przyłączeniowych Max. cross-section of cables	2,5mm ²	2,5mm ²	2,5mm ²	2,5mm ²	2,5mm ²
Montaż Installation	Na szynę/ DIN rail	Na szynę/ DIN rail	Na szynę/ DIN rail	Na szynę/ DIN rail	Na szynę/ DIN rail
Szerokość Width	1 moduł / 1 module	1 moduł / 1 module	1 moduł / 1 module	1 moduł / 1 module	1 moduł / 1 module
Funkcje Functions	SET/RESET	SET/RESET	-	-	-



OR-PRE-452/UNI

OR-PRE-453/UNI

Przełączniki czasowe

Time relays



OR-PRE-454/UNI



OR-PRE-454/230



OR-PRE-455

OR-PRE-452/UNI	OR-PRE-453/UNI	OR-PRE-454/UNI	OR-PRE-454/230	OR-PRE-455
5904988904938	5904988904945	5904988904952	5904988904969	5904988904976
Załączanie na ustawiony czas(Wu), uniwersalne zasilanie	Opóźnione załączenie(E), uniwersalne zasilanie	10 funkcji, uniwersalne zasilanie		Automat schodowy, 7 trybów pracy, 230 VAC
ON for the set interval (Wu), universal power supply	ON delay (E), universal power supply	10 functions, universal power supply		Staircase timer, 7 working modes, 230V AC

Ilość wyjść przełącznikowych Number of contacts	1P	1P	1P	1Z
 E - Opóźnione załączenie E - ON delay	-	✓	✓	-
 Wu - Załączenie na nastawiony czas Wu - ON for the set interval	✓	-	✓	-
 AUTO - Załączenie na nastawiony czas, wyzwalane włączeniem napięcia zasilania U lub zamknięciem zestyku sterującego S AUTO - ON for a set interval triggered by applying the supply voltage U or closing of the control contact S	-	-	-	✓
 Bp - Symetryczna praca cykliczna Bp - Symmetrical cyclical operation pause first	-	-	✓	-
 Bi - Symetryczna praca cykliczna rozpoczynająca się od załączenia Bi - Symmetrical cyclical operation pulse first	-	-	✓	-
 R - Opóźnione wyłączenie sterowane zestykiem S R - OFF delay with the control contact S	-	-	✓	✓
 Ws - Jednokrotne załączenie na nastawiony czas, wyzwalane zamknięciem zestyku sterującego S Ws - Single shot for the set interval triggered by closing of the control contact S	-	-	✓	-
 Wa - Załączenie na nastawiony czas, wyzwalane otwarciem zestyku sterującego S Wa - ON for the set interval triggered with the control contact S	-	-	✓	-
 Wi - Załączenie na nastawiony czas sterowane zamknięciami zestyku sterującego S, z funkcją wyłączenia przełącznika wykonawczego R przed upływem czasu T Wi - ON for the set interval controlled by closing of the control contact S, with the function of switching off the output relay R prior to the lapse of the interval T	-	-	-	✓
 Esa - Opóźnione załączenie i wyłączenie sterowane zestykiem S Esa - ON and OFF delay with the control contact S	-	-	✓	-
 B - Praca cykliczna sterowana zamykaniem zestyku sterującego S B - Cyclical operation controlled with closing of the control contact S	-	-	✓	-
 T - Generacja impulsu 0,5 s po upływie czasu T T - Generation of the 0,5 s pulse after the interval T	-	-	✓	-
 ON / OFF - Stałe załączenie / wyłączenie ON/OFF - Permanent switching on / off	✓	✓	✓	✓

Bloki rozdzielcze

Distribution blocks



Model Product no.	OR-LZ-8207/80	OR-LZ-8207/125	OR-LZ-8207/160	OR-LZ-8207/250
EAN	5908254828881	5908254828898	5908254828904	5908254828911
Prąd Current	80A	125A	160A	250A
Klasa palności UL94 Fire rating UL94	V2	V2	V2	V2
Zaciski wejściowe Input screw terminals	1 x 6-16 mm ²	1x 6-16; 1x 10-35mm ²	1 x 6 - 16mm ² ; 1 x 70 mm ²	1x 35-120mm ²
Zaciski wyjściowe Output screw terminals	4x 2,5-6; 2x 2,5-16 mm ²	6x 2,5-16 mm ²	6 x 16 mm ²	2x 6-35; 5x 2,5-16; 4x 2,5-10mm ²
Napięcie izolacji Ui wg IEC Ui acc. IEC	1000V	1000V	1000V	1000V
Napięcie izolacji Ui wg UL Ui acc. UL	600V	600V	600V	600V
Znamionowy prąd krótkotrwały wytzymywany lcv Short time withstand current lcv	3kA	4,2kA	11.80kA	24.50kA
Szczytowy prąd zwarcioowy wytzymywany lpk Peak short circuit current lpk	22kA	30kA	30kA	51kA
Spełniane normy Standards	IEC 60998-1, IEC 60998-2-1, IEC 60947-7-1, IEC 60947-7-1, UL 1059, UL 486E, CSA22.2 158-1987, GB 13140.1, GB 13140.2	IEC 60998-1, IEC 60998-2-1, IEC 60947-7-1, IEC 60947-7-1, UL 1059, UL 486E, CSA22.2 158-1987, GB 13140.1, GB 13140.2	IEC 60998-1, IEC 60998-2-1, IEC 60947-7-1, IEC 60947-7-1, UL 1059, UL 486E, CSA22.2 158-1987, GB 13140.1, GB 13140.2	IEC 60998-1, IEC 60998-2-1, IEC 60947-7-1, IEC 60947-7-1, UL 1059, UL 486E, CSA22.2 158-1987, GB 13140.1, GB 13140.2
Stopień ochrony Protection level	IP20	IP20	IP20	IP20
Montaż Installation	Na szynę DIN / na płytę montażową For DIN rail / mounting plate	Na szynę DIN / na płytę montażową For DIN rail / mounting plate	Na szynę DIN / na płytę montażową For DIN rail / mounting plate	Na szynę DIN / na płytę montażową For DIN rail / mounting plate
Moment dokręcania śrub Torque	Wejścia: 3,5 Wyjścia: 1; 3,5 Nm In: 3,5 Out: 1; 3,5 Nm	Wejścia: 3,5; 8,5 Wyjścia: 1; 3,5 Nm In: 3,5; 8,5 Out: 1; 3,5 Nm	Wejścia: 3,5; 8,5 Wyjścia: 1; 3,5 Nm In: 3,5; 8,5 Out: 1; 3,5 Nm	Wejścia: 19 Wyjścia: 4,4 ; 2,7 ; 2,7Nm
Wymiary [mm] Dimensions [mm]	30 / 46 / 65	30 / 77 / 46	30 / 77 / 46	49 / 96 / 50

Płytki odgałęźne

Junction plates



	Model Product no.	EAN	Liczba torów prądowych Circuit trucks number	Przekrój poprzeczny przewodu Wire cross-section	Ilość sztuk w opakowaniu [szt] Quantity per pack [pcs]
	OR-LZ-8206/4/2,5	5904988903146	4	2,5mm ²	1
	OR-LZ-8206/4/2,5/150	5904988903221	4	2,5mm ²	150
	OR-LZ-8206/4/4	5904988903153	4	4mm ²	1
	OR-LZ-8206/4/4/50	5904988903238	4	4mm ²	50
	OR-LZ-8206/4/10	5904988903160	4	10mm ²	1
	OR-LZ-8206/4/10/25	5904988903245	4	10mm ²	25
	OR-LZ-8206/4/16	5904988903177	4	16mm ²	1
	OR-LZ-8206/4/16/10	5904988903252	4	16mm ²	10
	OR-LZ-8206/5/2,5	5904988903184	5	2,5mm ²	1
	OR-LZ-8206/5/2,5/100	5904988903269	5	2,5mm ²	100
	OR-LZ-8206/5/4	5904988903191	5	4mm ²	1
	OR-LZ-8206/5/4/50	5904988903276	5	4mm ²	50
	OR-LZ-8206/5/10	5904988903207	5	10mm ²	1
	OR-LZ-8206/5/10/25	5904988903283	5	10mm ²	25
	OR-LZ-8206/5/16	5904988903214	5	16mm ²	1
	OR-LZ-8206/5/16/10	5904988903290	5	16mm ²	10

Watomierze i programatory

Power meters and programmers



Watomierze Power meters



OR-WAT-419



OR-WAT-419/B



OR-WAT-435



OR-WAT-435/B

Symbol Product no.	EAN	Zasilanie Power supply	Maks. obciążenie Max. load	Prąd Current	Pomiar napięcia Voltage measurement	Pomiar mocy Power measurement	Stopień ochrony Protection level	Standard gniazd Sockets standard	Kolor Color	Wymiary [mm] Dimensions [mm]
OR-WAT-419	5902560320169	230V~, 50Hz	3680W	16A	200 - 276V~	0,1 - 3680W	IP20	Francuski (typ E) French (type E)	Biały White	63 / 107 / 75
OR-WAT-419/B	5908254842931	230V~, 50Hz	3680W	16A	200 - 276V~	0,1 - 3680W	IP20	Francuski (typ E) French (type E)	Czarny Black	63 / 107 / 75
OR-WAT-435	5902560328493	230V~, 50Hz	3680W	16A	150 - 276V~	0,1 - 3680W	IP20	Francuski (typ E) French (type E)	Biały white	70 / 149 / 77,2
OR-WAT-435/B	5908254827945	230V~, 50Hz	3680W	16A	150 - 276V~	0,1 - 3680W	IP20	Francuski (typ E) French (type E)	Biały white	70 / 149 / 77,2



Watomierze Power meters



EM-4



EM-4/B







EM-5

Symbol Product no.	EAN	Zasilanie Power supply	Maks. obciążenie Max. load	Prąd Current	Pomiar napięcia Voltage measurement	Pomiar mocy Power measurement	Stopień ochrony Protection level	Standard gniazd Sockets standard	Kolor Color	Wymiary [mm] Dimensions [mm]
EM-4	5908254822414	230V~, 50Hz	3680W	16A	175 - 276V~	2 - 3680W	IP20	Francuski (typ E) French (type E)	Biały White	75 / 147 / 75
EM-4/B	5908254828362	230V~, 50Hz	3680W	16A	175 - 276V~	2 - 3680W	IP20	Francuski (typ E) French (type E)	Biały White	75 / 147 / 75
EM-5	5908254800917	230V~, 50Hz	3680W	16A	180 - 250V~	2 - 3680W	IP20	Francuski (typ E) French (type E)	Biały White	62 / 130 / 76



Elektroniczny programator astronomiczny i czasowy

Astronomical digital timer

-  Montaż na szynę DIN
DIN rail installation
-  Wbudowany akumulator
Built-in battery
-  Przerwa nocna
Night break
-  Stopień ochrony: IP20
Ingress protection: IP20



OR-PRE-450



OR-PRE-451

Symbol Product no.	EAN	Napięcie nominalne Nominal voltage	Nominalne obciążenie Nominal load	Maks. prąd Max. current	Ilość wyjść przełącznikowych Number of relay outputs	Ilość programów Number of programmes	Inne Others	Wymiary [mm] Dimensions [mm]
OR-PRE-450	5908254824586	24-264V AC/DC	2300W	16A	1	52	3 języki menu 3 menu languages	90 / 36 / 64
OR-PRE-451	5908254824593	24-264V AC/DC	2300W	16A	2	100	3 języki menu 3 menu languages	90 / 36 / 64

Gniazda i wtyczki

Sockets and plugs



OR-AE-13260/W



OR-AE-13260/B



OR-AE-13181/W



OR-AE-13181/B



OR-AE-13241/W



OR-AE-13241/B



OR-AE-13242/W



OR-AE-13242/B



OR-AE-13261/W



OR-AE-13261/B



OR-AE-13253/W



OR-AE-13253/B

Symbol Product no.	EAN	Typ wtyczki Plug type	Prąd Current	Standard wtyczki/ gniazda Plug/socket standard	Wtyczka kąтова Angular plug	Rodzaj połączenia Connection type	Uziemienie Grounding	Kolor Color
OR-AE-13260/W	5908254825873	2P	10A	Euro	-	Śrubowe Screw	-	Biały White
OR-AE-13260/B	5908254825866	2P	10A	Euro	-	Śrubowe Screw	-	Czarny Black
OR-AE-13181/W	5908254801921	2P	10A	Euro	-	Śrubowe Screw	-	Biały White
OR-AE-13181/B	5908254801938	2P	10A	Euro	-	Śrubowe Screw	-	Czarny Black
OR-AE-13241/W	5908254824463	2P	2,5A	Euro	-	Śrubowe Screw	-	Biały White
OR-AE-13241/B	5908254824500	2P	2,5A	Euro	-	Śrubowe Screw	-	Czarny Black
OR-AE-13242/W	5908254824487	2P	2,5A	Euro	-	Śrubowe Screw	-	Biały White
OR-AE-13242/B	5908254824524	2P	2,5A	Euro	-	Śrubowe Screw	-	Czarny Black
OR-AE-13261/W	5908254825897	2P+Z 2P+E	16A	Uni-schuko	✓	Śrubowe Screw	✓	Biały White
OR-AE-13261/B	5908254825880	2P+Z 2P+E	16A	Uni-schuko	✓	Śrubowe Screw	✓	Czarny Black
OR-AE-13253/W	5908254825231	2P+Z 2P+E	16A	Uni-schuko	✓	Śrubowe Screw	✓	Biały White
OR-AE-13253/B	5908254825224	2P+Z 2P+E	16A	Uni-schuko	✓	Śrubowe Screw	✓	Czarny Black

Przewody przyłączeniowe

Power cords



OR-AE-13286/W/1,9M



OR-AE-13286/B/1,9M



OR-AE-13282/3M
OR-AE-13283/3M



OR-AE-13284/3M
OR-AE-13285/3M

Symbol Product no.	EAN	Napięcie nominalne Nominal voltage	Prąd Current	Maks. obciążenie Max. load	Przekrój żyły Wire cross-section	Długość przewodu Wire length	Typ wtyczki Plug type	Uziemienie Grounding	Olejooodporny Oil resistant	Stopień ochrony Protection level	Materiał Material	Kolor Color
OR-AE-13286/W/1,9M	5908254841729	230V~, 50Hz	2,5A	500W	2x0,75mm ²	1,9m	Euro	-	-	IP20	PVC	Biały White
OR-AE-13286/B/1,9M	5908254841712	230V~, 50Hz	2,5A	500W	2x0,75mm ²	1,9m	Euro	-	-	IP20	PVC	Czarny Black
OR-AE-13282/3M	5908254841675	230V~, 50Hz	10A	2300W	2x1mm ²	3m	Uni-schuko	-	✓	IP20	Guma Rubber	Czarny Black
OR-AE-13283/3M	5908254841682	230V~, 50Hz	16A	3680W	2x1,5mm ²	3m	Uni-schuko	-	-	IP20	Guma Rubber	Czarny Black
OR-AE-13284/3M	5908254841699	230V~, 50Hz	10A	2300W	3x1mm ²	3m	Uni-schuko	✓	✓	IP44	Guma Rubber	Czarny Black
OR-AE-13285/3M	5908254841705	230V~, 50Hz	16A	3680W	3x1,5mm ²	3m	Uni-schuko	✓	-	IP44	Guma Rubber	Czarny Black

Łączniki kołyskowe z podświetleniem

Rocker switches with illumination



OR-AE-13179/R/W



OR-AE-13179/R/B



OR-AE-13179/G/W



OR-AE-13179/G/B





OR-AE-13179/W/W



OR-AE-13179/W/B

Symbol Product no.	EAN	Napięcie zasilania Nominal voltage	Prąd Current	Kolor przycisku Button color	Kolor obudowy Housing color	Wymiary [mm] Dimensions [mm]
OR-AE-13179/R/W	5908254827532	230V~, 50Hz	16A	Czerwony Red	Biały White	30 / 28,5
OR-AE-13179/R/B	5908254827549	230V~, 50Hz	16A	Czerwony Red	Czarny Black	30 / 28,5
OR-AE-13179/G/W	5908254827556	230V~, 50Hz	16A	Zielony Green	Biały White	30 / 28,5
OR-AE-13179/G/B	5908254827563	230V~, 50Hz	16A	Zielony Green	Czarny Black	30 / 28,5
OR-AE-13179/W/W	5908254827570	230V~, 50Hz	16A	Transparentny Transparent	Biały White	30 / 28,5
OR-AE-13179/W/B	5908254827587	230V~, 50Hz	16A	Transparentny Transparent	Czarny Black	30 / 28,5



	Symbol Product no.	EAN	Prąd Current	Standard gniazd Sockets standard	Ilość gniazd sieciowych Number of sockets	Kolor Color	Ilość sztuk w opakowaniu [szt] Quantity per pack [pcs]
	OR-AE-13277/W	5908254826894	5A	Euro	2x2P	Biały White	1
	OR-AE-13277/W/20	5908254826924	5A	Euro	2x2P	Biały White	10
	OR-AE-13278/W	5908254826900	7,5A	Euro	3x2P	Biały White	1
	OR-AE-13278/W/20	5908254826931	7,5A	Euro	3x2P	Biały White	10
	OR-AE-13279/W	5908254826917	10A	Euro	4x2P	Biały White	1
	OR-AE-13279/W/20	5908254826948	10A	Euro	4x2P	Biały White	10

Rozgałęźniki wielogniazdowe

Multi-socket splitters



	Symbol Product no.	EAN	Prąd Current	Standard gniazd Sockets standard	Ilość gniazd sieciowych Number of sockets	Kolor Color	Inne Others
	OR-AE-13270/W	5908254826443	16A	Francuski (typ E) French (type E)	2x2P+Z 2x2P+E	Biały White	-
	OR-AE-13255	5908254825163	16A	Euro	4x2P/II	Biały White	Z włącznikiem With switch
	OR-AE-13251	5908254825187	16A	Francuski (typ E) French (type E)	3x2P+Z 3x2P+E	Biały White	Wtyczka centralna Central plug
	OR-AE-13252	5908254825194	16A	Francuski (typ E) French (type E)	3x2P+Z 3x2P+E	Biały White	Wtyczka u góry Plug on top
	OR-AE-13238	5908254824319	16A	Francuski (typ E) French (type E)	2x2P+Z 2x2P+E	Biało-szary White-grey	-
	OR-AE-13239	5908254824326	16A	Francuski (typ E) French (type E)	3x2P+Z 3x2P+E	Biało-szary White-grey	-
	OR-AE-13240	5908254824333	16A	Francuski (typ E) French (type E)	4x2P+Z 4x2P+E	Biało-szary White-grey	-
	OR-AE-13281/G	5908254829734	16A	Francuski (typ E) French (type E)	2P+Z 2P+E	Biało-szary White-grey	2 porty USB (1xUSB-A, 1xUSB-C), szybkie ładowanie 2 USB ports (1xUSB-A, 1xUSB-C), quick charge
	ES-3	5908254825217	16A	Francuski (typ E) French (type E)	3x2P+Z 3x2P+E	Biały White	Z 3 włącznikami With 3 switches
	OR-AE-13270(GS)/W	5908254826450	16A	Schuko (typ F)	2x2P+Z 2x2P+E	Biały White	-
	OR-AE-13250(GS)	5908254825170	16A	Euro Schuko (typ F)	2x2P + 1x2P+Z 2x2P + 1x2P+E	Biały White	-
	OR-AE-13254(GS)	5908254825248	16A	Schuko (typ F)	3x2P+Z 3x2P+E	Biały White	Włącznik, wtyczka u góry Switch, plug on top
	OR-AE-13238(GS)	5908254824340	16A	Schuko (typ F)	2x2P+Z 2x2P+E	Biało-szary White-grey	-
	OR-AE-13239(GS)	5908254824357	16A	Schuko (typ F)	3x2P+Z 3x2P+E	Biało-szary White-grey	-
	OR-AE-13240(GS)	5908254824364	16A	Schuko (typ F)	4x2P+Z 4x2P+E	Biało-szary White-grey	-
	OR-AE-13246(GS)	5908254825729	16A	Schuko (typ F)	2P+Z 2P+E	Biało-szary White-grey	2 porty USB (1xUSB-A, 1xUSB-C) 2 USB ports (1xUSB-A, 1xUSB-C)
	OR-AE-13281(GS)/G	5908254829741	16A	Schuko (typ F)	2P+Z 2P+E	Biało-szary White-grey	2 porty USB (1xUSB-A, 1xUSB-C), szybkie ładowanie 2 USB ports (1xUSB-A, 1xUSB-C), quick charge
	ES-3(GS)	5908254825200	16A	Schuko (typ F)	3x2P+Z 3x2P+E	Biały White	Z 3 włącznikami With 3 switches

Rozgałęźniki wielogniazdowe

Multi-socket splitters



	Symbol Product no.	EAN	Prąd Current	Standard gniazd Sockets standard	Ilość gniazd sieciowych Number of sockets	Kolor Color	Inne Others
	OR-AE-13262/W	5908254826153	16A	Francuski (typ E) French (type E)	3x2P+Z 3x2P+E	Biały White	-
	OR-AE-13263/W	5908254826160	16A	Francuski (typ E) French (type E)	3x2P+Z 3x2P+E	Biały White	Z włącznikiem With switch
	OR-AE-13264/W	5908254826177	16A	Francuski (typ E) French (type E)	4x2P+Z 4x2P+E	Biały White	-
	OR-AE-13265/W	5908254826184	16A	Francuski (typ E) French (type E)	4x2P+Z 4x2P+E	Biały White	Z włącznikiem With switch
	OR-AE-13266/W	5908254826191	16A	Francuski (typ E) French (type E)	5x2P+Z 5x2P+E	Biały White	-
	OR-AE-13267/W	5908254826207	16A	Francuski (typ E) French (type E)	5x2P+Z 5x2P+E	Biały White	Z włącznikiem With switch
	OR-AE-13268/W	5908254826214	16A	Francuski (typ E) French (type E)	6x2P+Z 6x2P+E	Biały White	-
	OR-AE-13269/W	5908254826221	16A	Francuski (typ E) French (type E)	6x2P+Z 6x2P+E	Biały White	Z włącznikiem With switch
	OR-AE-13262(GS)/W	5908254826238	16A	Schuko (typ F)	3x2P+Z 3x2P+E	Biały White	-
	OR-AE-13263(GS)/W	5908254826245	16A	Schuko (typ F)	3x2P+Z 3x2P+E	Biały White	Z włącznikiem With switch
	OR-AE-13264(GS)/W	5908254826252	16A	Schuko (typ F)	4x2P+Z 4x2P+E	Biały White	-
	OR-AE-13265(GS)/W	5908254826269	16A	Schuko (typ F)	4x2P+Z 4x2P+E	Biały White	Z włącznikiem With switch
	OR-AE-13266(GS)/W	5908254826276	16A	Schuko (typ F)	5x2P+Z 5x2P+E	Biały White	-
	OR-AE-13267(GS)/W	5908254826283	16A	Schuko (typ F)	5x2P+Z 5x2P+E	Biały White	Z włącznikiem With switch
	OR-AE-13268(GS)/W	5908254826290	16A	Schuko (typ F)	6x2P+Z 6x2P+E	Biały White	-
	OR-AE-13269(GS)/W	5908254826306	16A	Schuko (typ F)	6x2P+Z 6x2P+E	Biały White	Z włącznikiem With switch

Seria ToDo ToDo series

Włączniki Switches



Montaż natynkowy
Surface mounting



Stopień ochrony IP20
Ingress protection IP20



Uniwersalność i prostota
Universality and simplicity



Loftowy design
Loft design



OR-OE-7200/W
OR-OE-7200/W/10



OR-OE-7200/B
OR-OE-7200/B/10



OR-OE-7201/W
OR-OE-7201/W/10



OR-OE-7201/B
OR-OE-7201/B/10

Symbol Product no.	EAN	Typ Type	Napięcie nominalne Nominal voltage	Prąd Current	Kolor Color	Wymiary [mm] Dimensions [mm]	Ilość sztuk w opakowaniu [szt] Quantity per pack [pcs]
OR-OE-7200/W	5908254828140	Łącznik jednobiegunowy Single-pole switch	230V~, 50Hz	10A	Biały White	63 / 63 / 35	1
OR-OE-7200/W/10	5908254828157	Łącznik jednobiegunowy Single-pole switch	230V~, 50Hz	10A	Biały White	63 / 63 / 35	10
OR-OE-7200/B	5908254828164	Łącznik jednobiegunowy Single-pole switch	230V~, 50Hz	10A	Czarny Black	63 / 63 / 35	1
OR-OE-7200/B/10	5908254828171	Łącznik jednobiegunowy Single-pole switch	230V~, 50Hz	10A	Czarny Black	63 / 63 / 35	10
OR-OE-7201/W	5908254828188	Łącznik świecznikowy Two-button switch	230V~, 50Hz	10A	Biały White	63 / 63 / 34	1
OR-OE-7201/W/10	5908254828195	Łącznik świecznikowy Two-button switch	230V~, 50Hz	10A	Biały White	63 / 63 / 34	10
OR-OE-7201/B	5908254828201	Łącznik świecznikowy Two-button switch	230V~, 50Hz	10A	Czarny Black	63 / 63 / 34	1
OR-OE-7201/B/10	5908254828218	Łącznik świecznikowy Two-button switch	230V~, 50Hz	10A	Czarny Black	63 / 63 / 34	10

Przycisk dzwonka

Doorbell button



OR-OE-7204/W
OR-OE-7204/W/10



OR-OE-7204/B
OR-OE-7204/B/10

Symbol Product no.	EAN	Typ Type	Napięcie nominalne Nominal voltage	Prąd Current	Kolor Color	Wymiary [mm] Dimensions [mm]	Ilość sztuk w opakowaniu [szt] Quantity per pack [pcs]
OR-OE-7204/W	5908254828300	Przycisk dzwonka Doorbell button	230V~, 50Hz	10A	Biały White	63 / 63 / 35	1
OR-OE-7204/W/10	5908254828317	Przycisk dzwonka Doorbell button	230V~, 50Hz	10A	Biały White	63 / 63 / 35	10
OR-OE-7204/B	5908254828324	Przycisk dzwonka Doorbell button	230V~, 50Hz	10A	Czarny Black	63 / 63 / 35	1
OR-OE-7204/B/10	5908254828331	Przycisk dzwonka Doorbell button	230V~, 50Hz	10A	Czarny Black	63 / 63 / 35	10



OR-OE-7205/W
OR-OE-7205/W/10



OR-OE-7205/B
OR-OE-7205/B/10



OR-OE-7205(GS)/W
OR-OE-7205(GS)/W/10



OR-OE-7205(GS)/B
OR-OE-7205(GS)/B/10

Gniazdka

Sockets

Symbol Product no.	EAN	Typ Type	Standard gniazd Sockets standard	Napięcie nominalne Nominal voltage	Prąd Current	Kolor Color	Wymiary [mm] Dimensions [mm]	Ilość sztuk w opakowaniu [szt] Quantity per pack [pcs]
OR-OE-7205/W	5908254828263	Gniazdo pojedyncze Single socket	Francuski (typ E) French (type E)	230V~, 50Hz	16A	Biały White	64 / 64 / 40	1
OR-OE-7205/W/10	5908254828270	Gniazdo pojedyncze Single socket	Francuski (typ E) French (type E)	230V~, 50Hz	16A	Biały White	64 / 64 / 40	10
OR-OE-7205/B	5908254828287	Gniazdo pojedyncze Single socket	Francuski (typ E) French (type E)	230V~, 50Hz	16A	Czarny Black	64 / 64 / 40	1
OR-OE-7205/B/10	5908254828294	Gniazdo pojedyncze Single socket	Francuski (typ E) French (type E)	230V~, 50Hz	16A	Czarny Black	64 / 64 / 40	10
OR-OE-7205(GS)/W	5908254828225	Gniazdo pojedyncze Single socket	Schuko (typ F)	230V~, 50Hz	16A	Biały White	64 / 64 / 40	1
OR-OE-7205(GS)/W/10	5908254828232	Gniazdo pojedyncze Single socket	Schuko (typ F)	230V~, 50Hz	16A	Biały White	64 / 64 / 40	10
OR-OE-7205(GS)/B	5908254828249	Gniazdo pojedyncze Single socket	Schuko (typ F)	230V~, 50Hz	16A	Czarny Black	64 / 64 / 40	1
OR-OE-7205(GS)/B/10	5908254828256	Gniazdo pojedyncze Single socket	Schuko (typ F)	230V~, 50Hz	16A	Czarny Black	64 / 64 / 40	10

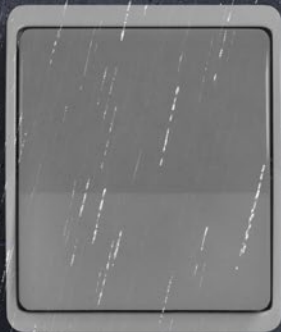

Seria AQUATIC

AQUATIC series



Montaż natynkowy
Surface mounting



Stopień ochrony IP44
Ingress protection IP44

Włłączniki

Switches



OR-OE-7100/W
OR-OE-7100/W/10



OR-OE-7101/W
OR-OE-7101/W/10



OR-OE-7102/W
OR-OE-7102/W/10



OR-OE-7103/W
OR-OE-7103/W/10



OR-OE-7100/B
OR-OE-7100/B/10



OR-OE-7101/B
OR-OE-7101/B/10



OR-OE-7102/B
OR-OE-7102/B/10



OR-OE-7103/B
OR-OE-7103/B/10



OR-OE-7100/GR
OR-OE-7100/GR/10



OR-OE-7101/GR
OR-OE-7101/GR/10



OR-OE-7102/GR
OR-OE-7102/GR/10



OR-OE-7103/GR
OR-OE-7103/GR

Symbol Product no.	EAN	Typ Type	Napięcie nominalne Nominal voltage	Prąd Current	Kolor Color	Wymiary [mm] Dimensions [mm]	Ilość sztuk w opakowaniu [szt] Quantity per pack [pcs]
OR-OE-7100/W	5904988902026	Łącznik jednobiegunowy Single-pole switch	230V~, 50Hz	10A	Biały White	63 / 75 / 48	1
OR-OE-7100/W/10	5904988902330	Łącznik jednobiegunowy Single-pole switch	230V~, 50Hz	10A	Biały White	63 / 75 / 48	10
OR-OE-7100/B	5904988902118	Łącznik jednobiegunowy Single-pole switch	230V~, 50Hz	10A	Czarny Black	63 / 75 / 48	1
OR-OE-7100/B/10	5904988902422	Łącznik jednobiegunowy Single-pole switch	230V~, 50Hz	10A	Czarny Black	63 / 75 / 48	10
OR-OE-7100/GR	5904988902200	Łącznik jednobiegunowy Single-pole switch	230V~, 50Hz	10A	Szaro-grafitowy Grey-graphite	63 / 75 / 48	1
OR-OE-7100/GR/10	5904988902514	Łącznik jednobiegunowy Single-pole switch	230V~, 50Hz	10A	Szaro-grafitowy Grey-graphite	63 / 75 / 48	10
OR-OE-7101/W	5904988902033	Łącznik świecznikowy Two-button switch	230V~, 50Hz	10A	Biały White	63 / 75 / 48	1
OR-OE-7101/W/10	5904988902347	Łącznik świecznikowy Two-button switch	230V~, 50Hz	10A	Biały White	63 / 75 / 48	10
OR-OE-7101/B	5904988902125	Łącznik świecznikowy Two-button switch	230V~, 50Hz	10A	Czarny Black	63 / 75 / 48	1
OR-OE-7101/B/10	5904988902439	Łącznik świecznikowy Two-button switch	230V~, 50Hz	10A	Czarny Black	63 / 75 / 48	10
OR-OE-7101/GR	5904988902217	Łącznik świecznikowy Two-button switch	230V~, 50Hz	10A	Szaro-grafitowy Grey-graphite	63 / 75 / 48	1
OR-OE-7101/GR/10	5904988902521	Łącznik świecznikowy Two-button switch	230V~, 50Hz	10A	Szaro-grafitowy Grey-graphite	63 / 75 / 48	10
OR-OE-7102/W	5904988902040	Łącznik schodowy Stairs connector	230V~, 50Hz	10A	Biały White	63 / 75 / 48	1
OR-OE-7102/W/10	5904988902354	Łącznik schodowy Stairs connector	230V~, 50Hz	10A	Biały White	63 / 75 / 48	10
OR-OE-7102/B	5904988902132	Łącznik schodowy Stairs connector	230V~, 50Hz	10A	Czarny Black	63 / 75 / 48	1
OR-OE-7102/B/10	5904988902446	Łącznik schodowy Stairs connector	230V~, 50Hz	10A	Czarny Black	63 / 75 / 48	10
OR-OE-7102/GR	5904988902224	Łącznik schodowy Stairs connector	230V~, 50Hz	10A	Szaro-grafitowy Grey-graphite	63 / 75 / 48	1
OR-OE-7102/GR/10	5904988902538	Łącznik schodowy Stairs connector	230V~, 50Hz	10A	Szaro-grafitowy Grey-graphite	63 / 75 / 48	10
OR-OE-7103/W	5904988902057	Łącznik krzyżowy Cross connector	230V~, 50Hz	10A	Biały White	63 / 75 / 48	1
OR-OE-7103/W/10	5904988902361	Łącznik krzyżowy Cross connector	230V~, 50Hz	10A	Biały White	63 / 75 / 48	10
OR-OE-7103/B	5904988902149	Łącznik krzyżowy Cross connector	230V~, 50Hz	10A	Czarny Black	63 / 75 / 48	1
OR-OE-7103/B/10	5904988902453	Łącznik krzyżowy Cross connector	230V~, 50Hz	10A	Czarny Black	63 / 75 / 48	10
OR-OE-7103/GR	5904988902231	Łącznik krzyżowy Cross connector	230V~, 50Hz	10A	Szaro-grafitowy Grey-graphite	63 / 75 / 48	1
OR-OE-7103/GR/10	5904988902545	Łącznik krzyżowy Cross connector	230V~, 50Hz	10A	Szaro-grafitowy Grey-graphite	63 / 75 / 48	10

Seria AQUATIC

AQUATIC series



Montaż natynkowy
Surface mounting



Stopień ochrony IP44
Ingress protection IP44



OR-OE-7105/WT
OR-OE-7105/WT/10
OR-OE-7105(GS)/WT
OR-OE-7105(GS)/WT/10



OR-OE-7106/WT
OR-OE-7106/WT/10
OR-OE-7106(GS)/WT
OR-OE-7106(GS)/WT/10



OR-OE-7104/W
OR-OE-7104/W/10



OR-OE-7105/W
OR-OE-7105/W/10
OR-OE-7105(GS)/W
OR-OE-7105(GS)/W/10

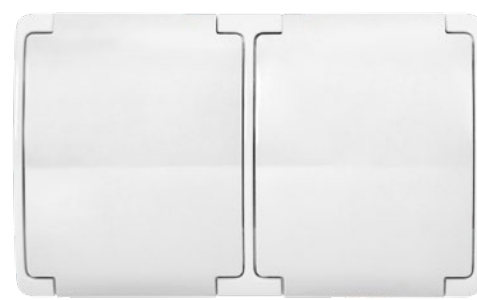

OR-OE-7106/W
OR-OE-7106/W/10
OR-OE-7106(GS)/W
OR-OE-7106(GS)/W/10



OR-OE-7104/B
OR-OE-7104/B/10



OR-OE-7105/B
OR-OE-7105/B/10
OR-OE-7105(GS)/B
OR-OE-7105(GS)/B/10



OR-OE-7106/B
OR-OE-7106/B/10
OR-OE-7106(GS)/B
OR-OE-7106(GS)/B/10



OR-OE-7104/GR
OR-OE-7104/GR/10



OR-OE-7105/GR
OR-OE-7105/GR/10
OR-OE-7105(GS)/GR
OR-OE-7105(GS)/GR/10

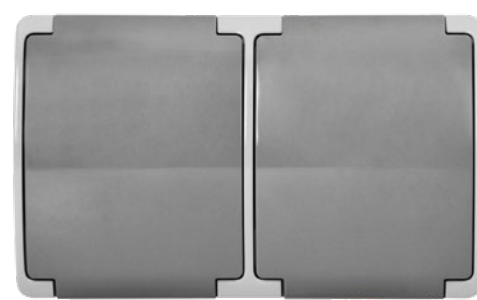

OR-OE-7106/GR
OR-OE-7106/GR/10
OR-OE-7106(GS)/GR
OR-OE-7106(GS)/GR/10

Przycisk dzwonka

Doorbell button

Symbol Product no.	EAN	Typ Type	Napięcie nominalne Nominal voltage	Prąd Current	Kolor Color	Wymiary [mm] Dimensions [mm]	Ilość sztuk w opakowaniu [szt] Quantity per pack [pcs]
OR-OE-7104/W	5904988902064	Przycisk dzwonka Doorbell button	230V~, 50Hz	10A	Biały White	63 / 75 / 48	1
OR-OE-7104/W/10	5904988902378	Przycisk dzwonka Doorbell button	230V~, 50Hz	10A	Biały White	63 / 75 / 48	10
OR-OE-7104/B	5904988902156	Przycisk dzwonka Doorbell button	230V~, 50Hz	10A	Czarny Black	63 / 75 / 48	1
OR-OE-7104/B/10	5904988902460	Przycisk dzwonka Doorbell button	230V~, 50Hz	10A	Biały White	63 / 75 / 48	10
OR-OE-7104/GR	5904988902248	Przycisk dzwonka Doorbell button	230V~, 50Hz	10A	Szaro-grafitowy Grey-graphite	63 / 75 / 48	1
OR-OE-7104/GR/10	5904988902552	Przycisk dzwonka Doorbell button	230V~, 50Hz	10A	Szaro-grafitowy Grey-graphite	63 / 75 / 48	10

Gniazdka

Sockets

Symbol Product no.	EAN	Typ Type	Standard gniazd Sockets standard	Napięcie nominalne Nominal voltage	Prąd Current	Kolor Color	Wymiary [mm] Dimensions [mm]	Ilość sztuk w opakowaniu [szt] Quantity per pack [pcs]
OR-OE-7105/W	5904988902071	Gniazdo pojedyncze Single socket	Francuski (typ E) French (type E)	230V~, 50Hz	16A	Biały White	63 / 75 / 48	1
OR-OE-7105/W/10	5904988902385	Gniazdo pojedyncze Single socket	Francuski (typ E) French (type E)	230V~, 50Hz	16A	Biały White	63 / 75 / 48	10
OR-OE-7105/WT	5904988902293	Gniazdo pojedyncze Single socket	Francuski (typ E) French (type E)	230V~, 50Hz	16A	Biały z klapką dymną White with smoky cover	63 / 75 / 48	1
OR-OE-7105/WT/10	5904988902606	Gniazdo pojedyncze Single socket	Francuski (typ E) French (type E)	230V~, 50Hz	16A	Biały z klapką dymną White with smoky cover	63 / 75 / 48	10
OR-OE-7105/B	5904988902163	Gniazdo pojedyncze Single socket	Francuski (typ E) French (type E)	230V~, 50Hz	16A	Czarny Black	63 / 75 / 48	1
OR-OE-7105/B/10	5904988902477	Gniazdo pojedyncze Single socket	Francuski (typ E) French (type E)	230V~, 50Hz	16A	Czarny Black	63 / 75 / 48	10
OR-OE-7105/GR	5904988902255	Gniazdo pojedyncze Single socket	Francuski (typ E) French (type E)	230V~, 50Hz	16A	Szaro-grafitowy Grey-graphite	63 / 75 / 48	1
OR-OE-7105/GR/10	5904988902569	Gniazdo pojedyncze Single socket	Francuski (typ E) French (type E)	230V~, 50Hz	16A	Szaro-grafitowy Grey-graphite	63 / 75 / 48	10
OR-OE-7105(GS)/W	5904988902095	Gniazdo pojedyncze Single socket	Schuko (typ F)	230V~, 50Hz	16A	Biały White	63 / 75 / 48	1
OR-OE-7105(GS)/W/10	5904988902408	Gniazdo pojedyncze Single socket	Schuko (typ F)	230V~, 50Hz	16A	Biały White	63 / 75 / 48	10
OR-OE-7105(GS)/WT	5904988902316	Gniazdo pojedyncze Single socket	Schuko (typ F)	230V~, 50Hz	16A	Biały z klapką dymną White with smoky cover	63 / 75 / 48	1
OR-OE-7105(GS)/WT/10	5904988902620	Gniazdo pojedyncze Single socket	Schuko (typ F)	230V~, 50Hz	16A	Biały z klapką dymną White with smoky cover	63 / 75 / 48	10
OR-OE-7105(GS)/B	5904988902187	Gniazdo pojedyncze Single socket	Schuko (typ F)	230V~, 50Hz	16A	Czarny Black	63 / 75 / 48	1
OR-OE-7105(GS)/B/10	5904988902491	Gniazdo pojedyncze Single socket	Schuko (typ F)	230V~, 50Hz	16A	Czarny Black	63 / 75 / 48	10
OR-OE-7105(GS)/GR	5904988902279	Gniazdo pojedyncze Single socket	Schuko (typ F)	230V~, 50Hz	16A	Szaro-grafitowy Grey-graphite	63 / 75 / 48	1
OR-OE-7105(GS)/GR/10	5904988902583	gniazdo pojedyncze single socket	Schuko (typ F)	230V~, 50Hz	16A	Szaro-grafitowy Grey-graphite	63 / 75 / 48	10
OR-OE-7106/W	5904988902088	Gniazdo podwójne Double socket	Francuski (typ E) French (type E)	230V~, 50Hz	16A	Biały White	123 / 75 / 48	1
OR-OE-7106/W/10	5904988902392	Gniazdo podwójne Double socket	Francuski (typ E) French (type E)	230V~, 50Hz	16A	Biały White	123 / 75 / 48	10
OR-OE-7106/WT	5904988902309	Gniazdo podwójne Double socket	Francuski (typ E) French (type E)	230V~, 50Hz	16A	Biały z klapką dymną White with smoky cover	123 / 75 / 48	1
OR-OE-7106/WT/10	5904988902613	Gniazdo podwójne Double socket	Francuski (typ E) French (type E)	230V~, 50Hz	16A	Biały z klapką dymną White with smoky cover	123 / 75 / 48	10
OR-OE-7106/B	5904988902170	Gniazdo podwójne Double socket	Francuski (typ E) French (type E)	230V~, 50Hz	16A	Czarny Black	123 / 75 / 48	1
OR-OE-7106/B/10	5904988902484	Gniazdo podwójne Double socket	Francuski (typ E) French (type E)	230V~, 50Hz	16A	Czarny Black	123 / 75 / 48	10
OR-OE-7106/GR	5904988902262	Gniazdo podwójne Double socket	Francuski (typ E) French (type E)	230V~, 50Hz	16A	Szaro-grafitowy Grey-graphite	123 / 75 / 48	1
OR-OE-7106/GR/10	5904988902576	Gniazdo podwójne Double socket	Francuski (typ E) French (type E)	230V~, 50Hz	16A	Szaro-grafitowy Grey-graphite	123 / 75 / 48	10
OR-OE-7106(GS)/W	5904988902101	Gniazdo podwójne Double socket	Schuko (typ F)	230V~, 50Hz	16A	Biały White	123 / 75 / 48	1
OR-OE-7106(GS)/W/10	5904988902415	Gniazdo podwójne Double socket	Schuko (typ F)	230V~, 50Hz	16A	Biały White	123 / 75 / 48	10
OR-OE-7106(GS)/WT	5904988902323	gniazdo podwójne double socket	Schuko (typ F)	230V~, 50Hz	16A	Biały z klapką dymną White with smoky cover	123 / 75 / 48	1
OR-OE-7106(GS)/WT/10	5904988902637	Gniazdo podwójne Double socket	Schuko (typ F)	230V~, 50Hz	16A	Biały z klapką dymną White with smoky cover	123 / 75 / 48	10
OR-OE-7106(GS)/B	5904988902194	Gniazdo podwójne Double socket	Schuko (typ F)	230V~, 50Hz	16A	Czarny Black	123 / 75 / 48	1
OR-OE-7106(GS)/B/10	5904988902507	Gniazdo podwójne Double socket	Schuko (typ F)	230V~, 50Hz	16A	Czarny Black	123 / 75 / 48	10
OR-OE-7106(GS)/GR	5904988902286	Gniazdo podwójne Double socket	Schuko (typ F)	230V~, 50Hz	16A	Szaro-grafitowy Grey-graphite	123 / 75 / 48	1
OR-OE-7106(GS)/GR/10	5904988902590	Gniazdo podwójne Double socket	Schuko (typ F)	230V~, 50Hz	16A	Szaro-grafitowy Grey-graphite	123 / 75 / 48	10

Seria AQUATIC MINI

AQUATIC MINI series



Montaż natynkowy
Surface mounting



Stopień ochrony IP54
Ingress protection IP54



Mały rozmiar
Small size



OR-OE-7300/WB
OR-OE-7300/WB/10

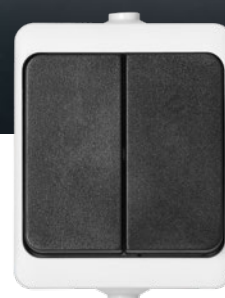

OR-OE-7301/WB
OR-OE-7301/WB/10

Włłączniki

Switches

Symbol Product no.	EAN	Typ Type	Napięcie nominalne Nominal voltage	Prąd Current	Kolor Color	Wymiary [mm] Dimensions [mm]	Ilość sztuk w opakowaniu [szt] Quantity per pack [pcs]
OR-OE-7300/WB	5908254829277	Łącznik jednobiegunowy Single-pole switch	230V~, 50Hz	10A	Biało-czarny White-black	54 / 65 / 38	1
OR-OE-7300/WB/10	5908254830709	Łącznik jednobiegunowy Single-pole switch	230V~, 50Hz	10A	Biało-czarny White-black	54 / 65 / 38	10
OR-OE-7301/WB	5908254829284	Łącznik świecznikowy Two-button switch	230V~, 50Hz	10A	Biało-czarny White-black	54 / 65 / 38	1
OR-OE-7301/WB/10	5908254830716	Łącznik świecznikowy Two-button switch	230V~, 50Hz	10A	Biało-czarny White-black	54 / 65 / 38	10



OR-OE-7304/WB

Przycisk dzwonka

Doorbell button

Symbol Product no.	EAN	Typ Type	Napięcie nominalne Nominal voltage	Prąd Current	Kolor Color	Wymiary [mm] Dimensions [mm]	Ilość sztuk w opakowaniu [szt] Quantity per pack [pcs]
OR-OE-7304/WB	5908254829291	Przycisk dzwonka Doorbell button	230V~, 50Hz	10A	Biało-czarny White-black	54 / 65 / 38	1
OR-OE-7304/WB	5908254830723	Przycisk dzwonka Doorbell button	230V~, 50Hz	10A	Biało-czarny White-black	54 / 65 / 38	10



Gniazdko Sockets

OR-OE-7305/WB
OR-OE-7305/WB/10
OR-OE-7305(GS)/WB
OR-OE-7305(GS)/WB/10

OR-OE-7306/WB
OR-OE-7306/WB/5
OR-OE-7306(GS)/WB
OR-OE-7306(GS)/WB/5

OR-OE-7307/WB
OR-OE-7307/WB/5
OR-OE-7307(GS)/WB
OR-OE-7307(GS)/WB/5

Symbol Product no.	EAN	Typ Type	Standard gniazdo Sockets standard	Napięcie nominalne Nominal voltage	Prąd Current	Kolor Color	Wymiary [mm] Dimensions [mm]	Ilość sztuk w opakowaniu [szt] Quantity per pack [pcs]
OR-OE-7305/WB	5908254829307	Gniazdo pojedyncze Single socket	Francuski (typ E) French (type E)	230V~, 50Hz	16A	Biało-czarny White-black	54 / 65 / 38	1
OR-OE-7305/WB/10	5908254830730	Gniazdo pojedyncze Single socket	Francuski (typ E) French (type E)	230V~, 50Hz	16A	Biało-czarny White-black	54 / 65 / 38	10
OR-OE-7306/WB	5908254829321	Gniazdo podwójne Double socket	Francuski (typ E) French (type E)	230V~, 50Hz	16A	Biało-czarny White-black	108 / 65 / 38	1
OR-OE-7306/WB/5	5908254830754	Gniazdo podwójne Double socket	Francuski (typ E) French (type E)	230V~, 50Hz	16A	Biało-czarny White-black	108 / 65 / 38	5
OR-OE-7305(GS)/WB	5908254829314	Gniazdo pojedyncze Single socket	Schuko (typ F)	230V~, 50Hz	16A	Biało-czarny White-black	54 / 65 / 38	1
OR-OE-7305(GS)/WB/10	5908254830747	Gniazdo pojedyncze Single socket	Schuko (typ F)	230V~, 50Hz	16A	Biało-czarny White-black	54 / 65 / 38	10
OR-OE-7306(GS)/WB	5908254829338	Gniazdo podwójne Double socket	Schuko (typ F)	230V~, 50Hz	16A	Biało-czarny White-black	108 / 65 / 38	1
OR-OE-7306(GS)/WB/5	5908254830761	Gniazdo podwójne Double socket	Schuko (typ F)	230V~, 50Hz	16A	Biało-czarny White-black	108 / 65 / 38	5

Włacznik + gniazdko Switch + socket

Symbol Product no.	EAN	Typ Type	Standard gniazdo Sockets standard	Napięcie nominalne Nominal voltage	Prąd Current	Kolor Color	Wymiary [mm] Dimensions [mm]	Ilość sztuk w opakowaniu [szt] Quantity per pack [pcs]
OR-OE-7307/WB	5908254829345	Łącznik jednobiegunowy/gniazdo Single-pole switch/socket	Francuski (typ E) French (type E)	230V~, 50Hz	10/16A	Biało-czarny White-black	54 / 130 / 38	1
OR-OE-7307/WB/5	5908254830778	Łącznik jednobiegunowy/gniazdo Single-pole switch/socket	Francuski (typ E) French (type E)	230V~, 50Hz	10/16A	Biało-czarny White-black	54 / 130 / 38	5
OR-OE-7307(GS)/WB	5908254829352	Łącznik jednobiegunowy/gniazdo Single-pole switch/socket	Schuko (typ F)	230V~, 50Hz	10/16A	Biało-czarny White-black	54 / 130 / 38	1
OR-OE-7307(GS)/WB/5	5908254830785	Łącznik jednobiegunowy/gniazdo Single-pole switch/socket	Schuko (typ F)	230V~, 50Hz	10/16A	Biało-czarny White-black	54 / 130 / 38	5



Seria AQUATIC PRO

AQUATIC PRO series



Montaż natynkowy
Surface mounting



Stopień ochrony IP55
Ingress protection IP55



Odporność na wyjątkowo ciężkie warunki
Heavy conditions resistance



OR-OE-7400/GR
OR-OE-7400/GR/10



OR-OE-7400/P/GR
OR-OE-7400/P/GR/10



OR-OE-7401/GR
OR-OE-7401/GR/10



OR-OE-7408/GR
OR-OE-7408/GR/10

Włączniki

Switches

Symbol Product no.	EAN	Typ Type	Napięcie nominalne Nominal voltage	Prąd Current	Kolor Color	Wymiary [mm] Dimensions [mm]	Ilość sztuk w opakowaniu [szt] Quantity per pack [pcs]
OR-OE-7400/GR	5908254829369	Łącznik jednobiegunowy Single-pole switch	230V~, 50Hz	10A	Szary Grey	65 / 75 / 55	1
OR-OE-7400/GR/10	5908254830792	Łącznik jednobiegunowy Single-pole switch	230V~, 50Hz	10A	Szary Grey	65 / 75 / 55	10
OR-OE-7400/P/GR	5908254829383	Łącznik jednobiegunowy z podświetleniem Single-pole switch with illumination	230V~, 50Hz	10A	Szary Grey	65 / 75 / 55	1
OR-OE-7400/P/GR/10	5908254830815	Łącznik jednobiegunowy z podświetleniem Single-pole switch with illumination	230V~, 50Hz	10A	Szary Grey	65 / 75 / 55	10
OR-OE-7401/GR	5908254829376	Łącznik świecznikowy Two-button switch	230V~, 50Hz	10A	Szary Grey	65 / 75 / 55	1
OR-OE-7401/GR/10	5908254830808	Łącznik świecznikowy Two-button switch	230V~, 50Hz	10A	Szary Grey	65 / 75 / 55	10
OR-OE-7408/GR	5908254829451	Łącznik roletowy Shutter switch	230V~, 50Hz	10A	Szary Grey	65 / 75 / 55	1
OR-OE-7408/GR/10	5908254830884	Łącznik roletowy Shutter switch	230V~, 50Hz	10A	Szary Grey	65 / 75 / 55	10



OR-OE-7404/GR
OR-OE-7404/GR/10



OR-OE-7404/P/GR
OR-OE-7404/P/GR/10



OR-OE-7405/GR
OR-OE-7405/GR/10
OR-OE-7405(GS)/GR
OR-OE-7405(GS)/GR/10



OR-OE-7406/GR
OR-OE-7406/GR/5



OR-OE-7407/GR
OR-OE-7407/GR/5

Przycisk dzwonka

Doorbell button

Symbol Product no.	EAN	Typ Type	Napięcie nominalne Nominal voltage	Prąd Current	Kolor Color	Wymiary [mm] Dimensions [mm]	Ilość sztuk w opakowaniu [szt] Quantity per pack [pcs]
OR-OE-7404/GR	5908254829390	Przycisk dzwonka Doorbell button	230V~, 50Hz	10A	Szary Grey	65 / 75 / 55	1
OR-OE-7404/GR/10	5908254830822	Przycisk dzwonka Doorbell button	230V~, 50Hz	10A	Szary Grey	65 / 75 / 55	10
OR-OE-7404/P/GR	5908254829406	Przycisk dzwonka z podświetleniem Doorbell button with illumination	230V~, 50Hz	10A	Szary Grey	65 / 75 / 55	1
OR-OE-7404/P/GR/10	5908254830839	Przycisk dzwonka z podświetleniem Doorbell button with illumination	230V~, 50Hz	10A	Szary Grey	65 / 75 / 55	10

Gniazdka

Sockets

Symbol Product no.	EAN	Typ Type	Standard gniazd Sockets standard	Napięcie nominalne Nominal voltage	Prąd Current	Kolor Color	Wymiary [mm] Dimensions [mm]	Ilość sztuk w opakowaniu [szt] Quantity per pack [pcs]
OR-OE-7405/GR	5908254829413	Gniazdo pojedyncze Single socket	Francuski (typ E) French (type E)	230V~, 50Hz	16A	Szary Grey	65 / 75 / 55	1
OR-OE-7405/GR/10	5908254830846	Gniazdo pojedyncze Single socket	Francuski (typ E) French (type E)	230V~, 50Hz	16A	Szary Grey	65 / 75 / 55	10
OR-OE-7406/GR	5908254829437	Gniazdo podwójne Double socket	Francuski (typ E) French (type E)	230V~, 50Hz	16A	Szary Grey	130 / 75 / 55	1
OR-OE-7406/GR/5	5908254830860	Gniazdo podwójne Double socket	Francuski (typ E) French (type E)	230V~, 50Hz	16A	Szary Grey	130 / 75 / 55	5
OR-OE-7405(GS)/GR	5908254829420	Gniazdo pojedyncze Single socket	Schuko (typ F)	230V~, 50Hz	16A	Szary Grey	65 / 75 / 55	1
OR-OE-7405(GS)/GR/10	5908254830853	Gniazdo pojedyncze Single socket	Schuko (typ F)	230V~, 50Hz	16A	Szary Grey	65 / 75 / 55	10

Włącznik + gniazdko

Switch + socket

Symbol Product no.	EAN	Typ Type	Standard gniazd Sockets standard	Napięcie nominalne Nominal voltage	Prąd Current	Kolor Color	Wymiary [mm] Dimensions [mm]	Ilość sztuk w opakowaniu [szt] Quantity per pack [pcs]
OR-OE-7407/GR	5908254829444	Łącznik jednobiegunowy/gniazdko Single-pole switch/socket	Francuski (typ E) French (type E)	230V~, 50Hz	10/16A	Szary Grey	150 / 75 / 55	1
OR-OE-7407/GR/5	5908254830877	Łącznik jednobiegunowy/gniazdko Single-pole switch/socket	Francuski (typ E) French (type E)	230V~, 50Hz	10/16A	Szary Grey	150 / 75 / 55	5

Gniazda i wtyczki przyczep

Trailer plugs and sockets





Model Product no.	OR-AE-1384	OR-AE-1385	OR-AE-1386	OR-AE-1387
EAN	5901752489882	5901752489899	5901752489905	5901752489912
Napięcie zasilania Nominal voltage	12/24V DC	12/24V DC	12/24V DC	12/24V DC
Ilość pinów Number of pins	7	7	7	7
Materiał Material	PA	Aluminium	PA	Aluminium
Kolor Color	Czarny Black	Srebrny Silver	Czarny Black	Srebrny Silver
Wymiary (szer./wys./gt.) [mm] Dimensions (W/H/D) [mm]	50 / 100 / 40	75 / 72 / 50	75 / 72 / 50	70 / 70 / 52







Model Product no.	OR-AE-13288	OR-AE-13229	OR-AE-13228	OR-AE-13230
EAN	5908254842849	5908254814563	5908254814556	5908254814570
Napięcie zasilania Nominal voltage	12/24V DC	12/24V DC	12/24V DC	12/24V DC
Ilość pinów Number of pins	7/13	13/7	13	13
Materiał Material	PA	PA	PA	PA
Kolor Color	Czarny Black	Czarny Black	Czarny Black	Czarny Black
Wymiary (szer./wys./gt.) [mm] Dimensions (W/H/D) [mm]	83 / 50 / 50	44,9 / 63,6 / 51,8	48,5 / 58,2 / 118,4	62,4 / 72 / 50,7

Osprzęt warsztatowy

Workshop plugs and sockets

Gniazda warsztatowe Workshop sockets

ORNO
FOR PROFESSIONALS



	Symbol Product no.	EAN	Napięcie nominalne Nominal voltage	Prąd Current	Standard gniazd Sockets standard	Uziemienie Grounding	Rodzaj połączenia Connection type	Ilość sztuk w opakowaniu [szt] Quantity per pack [pcs]
	OR-AE-13258	5908254825835	230V~, 50Hz	16A	Francuski (typ E) French (type E)	✓	Śrubowe Screw	1
	OR-AE-13258/12	5908254826078	230V~, 50Hz	16A	Francuski (typ E) French (type E)	✓	Śrubowe Screw	12
	OR-AE-13257	5908254825811	230V~, 50Hz	16A	Francuski (typ E) French (type E)	✓	Śrubowe Screw	1
	OR-AE-13257/12	5908254826054	230V~, 50Hz	16A	Francuski (typ E) French (type E)	✓	Śrubowe Screw	12
	OR-AE-13258(GS)	5908254825842	230V~, 50Hz	16A	Schuko (typ F)	✓	Śrubowe Screw	1
	OR-AE-13258(GS)/12	5908254826085	230V~, 50Hz	16A	Schuko (typ F)	✓	Śrubowe Screw	12
	OR-AE-13257(GS)	5908254825828	230V~, 50Hz	16A	Schuko (typ F)	✓	Śrubowe Screw	1
	OR-AE-13257(GS)/12	5908254826061	230V~, 50Hz	16A	Schuko (typ F)	✓	Śrubowe Screw	12

Wtyczki warsztatowe

Workshop plugs

ORNO
FOR PROFESSIONALS



	Symbol Product no.	EAN	Napięcie nominalne Nominal voltage	Prąd Current	Standard wtyczki Plugs standard	Uziemienie Grounding	Rodzaj połączenia Connection type	Ilość sztuk w opakowaniu [szt] Quantity per pack [pcs]
	OR-AE-13259	5908254825859	230V~, 50Hz	16A	Uni- Schuko	✓	Śrubowe Screw	1
	OR-AE-13259/24	5908254826092	230V~, 50Hz	16A	Uni- Schuko	✓	Śrubowe Screw	24
	OR-AE-13256	5908254825804	230V~, 50Hz	16A	Uni- Schuko	✓	Śrubowe Screw	1
	OR-AE-13256/24	5908254826047	230V~, 50Hz	16A	Uni- Schuko	✓	Śrubowe Screw	24

Przedłużacze domowe

Home extension sockets



ViRONE
simple made easy.

Przedłużacze domowe z płaską wtyczką

Home extension sockets with flat plug



Standard gniazd
Sockets standard



ES-1/B/1,5M
ES-1/B/3M



ES-2/W/1,4M



ES-4/B/1,5
ES-4/B/3
ES-4/B/5



ES-4/W/1,5
ES-4/W/3
ES-4/W/5



ES-5/B/1,5
ES-5/B/3
ES-5/B/5



ES-5/W/1,5
ES-5/W/3
ES-5/W/5



ES-6/B/1,5
ES-6/B/3
ES-6/B/5



ES-6/W/1,5
ES-6/W/3
ES-6/W/5



ES-7/B/1,5
ES-7/B/3
ES-7/B/5



ES-7/W/1,5
ES-7/W/3
ES-7/W/5

Symbol Product no.	EAN	Maks. obciążenie Max. load	Prąd Current	Ilość gniazd Number of sockets	Typ gniazda Socket type	Typ izolacji Insulation type	Przekrój żyły Wire cross-section	Długość przewodu Cable length	Wyłłącznik Switch	Kolor Color
ES-2/W/1,4M	5908254815898	2500W	2,5A	4	Euro (typ C)	PVC	1 mm ²	1,4m	✓	Biały White
ES-1/B/1,5M	5908254814723	500W	10A	6	Euro (typ C)	PVC	1,0 mm ²	1,5m	✓	Czarny Black
ES-1/B/3M	5908254814730	500W	10A	6	Francuski (typ E) French (type E)	PVC	1,0 mm ²	3m	✓	Czarny Black
ES-4/B/1,5	5908254829772	3680W	16A	3	Francuski (typ E) French (type E)	PVC	1,5 mm ²	1,5m	-	Czarny Black
ES-4/B/3	5908254829796	3680W	16A	3	Francuski (typ E) French (type E)	PVC	1,5 mm ²	3m	-	Czarny Black
ES-4/B/5	5908254829819	3680W	16A	3	Francuski (typ E) French (type E)	PVC	1,5 mm ²	5m	-	Czarny Black
ES-4/W/1,5	5908254829765	3680W	16A	3	Francuski (typ E) French (type E)	PVC	1,5 mm ²	1,5m	-	Biały White
ES-4/W/3	5908254829789	3680W	16A	3	Francuski (typ E) French (type E)	PVC	1,5 mm ²	3m	-	Biały White
ES-4/W/5	5908254829802	3680W	16A	3	Francuski (typ E) French (type E)	PVC	1,5 mm ²	5m	-	Biały White
ES-5/B/1,5	5908254829833	3680W	16A	3	Francuski (typ E) French (type E)	PVC	1,5 mm ²	1,5m	✓	Czarny Black
ES-5/B/3	5908254829857	3680W	16A	3	Francuski (typ E) French (type E)	PVC	1,5 mm ²	3m	✓	Czarny Black
ES-5/B/5	5908254829871	3680W	16A	3	Francuski (typ E) French (type E)	PVC	1,5 mm ²	5m	✓	Czarny Black
ES-5/W/1,5	5908254829826	3680W	16A	3	Francuski (typ E) French (type E)	PVC	1,5 mm ²	1,5m	✓	Biały White
ES-5/W/3	5908254829840	3680W	16A	3	Francuski (typ E) French (type E)	PVC	1,5 mm ²	3m	✓	Biały White
ES-5/W/5	5908254829864	3680W	16A	3	Francuski (typ E) French (type E)	PVC	1,5 mm ²	5m	✓	Biały White
ES-6/B/1,5	5908254829895	3680W	16A	5	Francuski (typ E) French (type E)	PVC	1,5 mm ²	1,5m	-	Czarny Black
ES-6/B/3	5908254829918	3680W	16A	5	Francuski (typ E) French (type E)	PVC	1,5 mm ²	3m	-	Czarny Black
ES-6/B/5	5908254829932	3680W	16A	5	Francuski (typ E) French (type E)	PVC	1,5 mm ²	5m	-	Czarny Black
ES-6/W/1,5	5908254829888	3680W	16A	5	Francuski (typ E) French (type E)	PVC	1,5 mm ²	1,5m	-	Biały White
ES-6/W/3	5908254829901	3680W	16A	5	Francuski (typ E) French (type E)	PVC	1,5 mm ²	3m	-	Biały White
ES-6/W/5	5908254829925	3680W	16A	5	Francuski (typ E) French (type E)	PVC	1,5 mm ²	5m	-	Biały White
ES-7/B/1,5	5908254829956	3680W	16A	5	Francuski (typ E) French (type E)	PVC	1,5 mm ²	1,5m	✓	Czarny Black
ES-7/B/3	5908254829970	3680W	16A	5	Francuski (typ E) French (type E)	PVC	1,5 mm ²	3m	✓	Czarny Black
ES-7/B/5	5908254829994	3680W	16A	5	Francuski (typ E) French (type E)	PVC	1,5 mm ²	5m	✓	Czarny Black
ES-7/W/1,5	5908254829949	3680W	16A	5	Francuski (typ E) French (type E)	PVC	1,5 mm ²	1,5m	✓	Biały White
ES-7/W/3	5908254829963	3680W	16A	5	Francuski (typ E) French (type E)	PVC	1,5 mm ²	3m	✓	Biały White
ES-7/W/5	5908254829987	3680W	16A	5	Francuski (typ E) French (type E)	PVC	1,5 mm ²	5m	✓	Biały White



Przedłużacze domowe z płaską wtyczką

Home extension sockets with flat plug



Standard gniazd
Sockets standard



ES-1(GS)/B/1,5M
ES-1(GS)/B/3M



ES-4(GS)/B/1,5
ES-4(GS)/B/3
ES-4(GS)/B/5



ES-4(GS)/W/1,5
ES-4(GS)/W/3
ES-4(GS)/W/5



ES-5(GS)/B/1,5
ES-5(GS)/B/3
ES-5(GS)/B/5



ES-5(GS)/W/1,5
ES-5(GS)/W/3
ES-5(GS)/W/5



ES-6(GS)/B/1,5
ES-6(GS)/B/3
ES-6(GS)/B/5



ES-6(GS)/W/1,5
ES-6(GS)/W/3
ES-6(GS)/W/5



ES-7(GS)/B/1,5
ES-7(GS)/B/3
ES-7(GS)/B/5



ES-7(GS)/W/1,5
ES-7(GS)/W/3
ES-7(GS)/W/5

Symbol Product no.	EAN	Maks. obciążenie Max. load	Prąd Current	Ilość gniazd Number of sockets	Typ gniazda Socket type	Typ izolacji Insulation type	Przekrój żyły Wire cross-section	Długość przewodu Cable length	Wyłłącznik Switch	Kolor Color
ES-1(GS)/B/1,5M	5908254817212	2300W	10A	6	Schuko (typ F)	PVC	1,0 mm ²	1,5m	✓	Czarny Black
ES-1(GS)/B/3M	5908254817229	2300W	10A	6	Schuko (typ F)	PVC	1,0 mm ²	3m	✓	Czarny Black
ES-4(GS)/B/1,5	5908254840012	3680W	16A	3	Schuko (typ F)	PVC	1,5 mm ²	1,5m	-	Czarny Black
ES-4(GS)/B/3	5908254840036	3680W	16A	3	Schuko (typ F)	PVC	1,5 mm ²	3m	-	Czarny Black
ES-4(GS)/B/5	5908254840050	3680W	16A	3	Schuko (typ F)	PVC	1,5 mm ²	5m	-	Czarny Black
ES-4(GS)/W/1,5	5908254840005	3680W	16A	3	Schuko (typ F)	PVC	1,5 mm ²	1,5m	-	Biały White
ES-4(GS)/W/3	5908254840029	3680W	16A	3	Schuko (typ F)	PVC	1,5 mm ²	3m	-	Biały White
ES-4(GS)/W/5	5908254840043	3680W	16A	3	Schuko (typ F)	PVC	1,5 mm ²	5m	-	Biały White
ES-5(GS)/B/1,5	5908254840074	3680W	16A	3	Schuko (typ F)	PVC	1,5 mm ²	1,5m	✓	Czarny Black
ES-5(GS)/B/3	5908254840098	3680W	16A	3	Schuko (typ F)	PVC	1,5 mm ²	3m	✓	Czarny Black
ES-5(GS)/B/5	5908254840111	3680W	16A	3	Schuko (typ F)	PVC	1,5 mm ²	5m	✓	Czarny Black
ES-5(GS)/W/1,5	5908254840067	3680W	16A	3	Schuko (typ F)	PVC	1,5 mm ²	1,5m	✓	Biały White
ES-5(GS)/W/3	5908254840081	3680W	16A	3	Schuko (typ F)	PVC	1,5 mm ²	3m	✓	Biały White
ES-5(GS)/W/5	5908254840104	3680W	16A	3	Schuko (typ F)	PVC	1,5 mm ²	5m	✓	Biały White
ES-6(GS)/B/1,5	5908254840135	3680W	16A	5	Schuko (typ F)	PVC	1,5 mm ²	1,5m	-	Czarny Black
ES-6(GS)/B/3	5908254840159	3680W	16A	5	Schuko (typ F)	PVC	1,5 mm ²	3m	-	Czarny Black
ES-6(GS)/B/5	5908254840173	3680W	16A	5	Schuko (typ F)	PVC	1,5 mm ²	5m	-	Czarny Black
ES-6(GS)/W/1,5	5908254840128	3680W	16A	5	Schuko (typ F)	PVC	1,5 mm ²	1,5m	-	Biały White
ES-6(GS)/W/3	5908254840142	3680W	16A	5	Schuko (typ F)	PVC	1,5 mm ²	3m	-	Biały White
ES-6(GS)/W/5	5908254840166	3680W	16A	5	Schuko (typ F)	PVC	1,5 mm ²	5m	-	Biały White
ES-7(GS)/B/1,5	5908254840197	3680W	16A	5	Schuko (typ F)	PVC	1,5 mm ²	1,5m	✓	Czarny Black
ES-7(GS)/B/3	5908254840210	3680W	16A	5	Schuko (typ F)	PVC	1,5 mm ²	3m	✓	Czarny Black
ES-7(GS)/B/5	5908254840234	3680W	16A	5	Schuko (typ F)	PVC	1,5 mm ²	5m	✓	Czarny Black
ES-7(GS)/W/1,5	5908254840180	3680W	16A	5	Schuko (typ F)	PVC	1,5 mm ²	1,5m	✓	Biały White
ES-7(GS)/W/3	5908254840203	3680W	16A	5	Schuko (typ F)	PVC	1,5 mm ²	3m	✓	Biały White
ES-7(GS)/W/5	5908254840227	3680W	16A	5	Schuko (typ F)	PVC	1,5 mm ²	5m	✓	Biały White

Listwy zasilające

Power strips

Listwy przeciwprzebieciowe

Power strip with surge protection

ViRONE
simple made easy.



Ochronnik przeciwprzebieciowy
Surge protection



Płaska wtyczka
Flat plug



Ładowarka USB 2xUSB-A
USB charger 2xUSB-A



Podświetlany włącznik
dwutorowy
Two-track backlit switch



Podświetlany przycisk
dwutorowy
Backlit button



PS-1/B/1,5M



PS-2/B/1,5M



PS-1(GS)/B/1,5M

Symbol Product no.	EAN	Napięcie nominalne Nominal voltage	Maks. obciążenie Max. load	Prąd Current	Ilość gniazd Number of sockets	Typ gniazda Socket type	Typ izolacji Insulation type	Przekrój żyty Wire cross-section	Długość przewodu Cable length
PS-1/B/1,5M	5908254814716	230V~, 50Hz	2300W	10A	5	Francuski (typ E) French (type E)	PVC	1,0 mm ²	1,5m
PS-2/B/1,5M	5908254819018	230V~, 50Hz	2300W	10A	5	Francuski (typ E) French (type E)	PVC	1,0 mm ²	1,5m
PS-1(GS)/B/1,5M	5908254817236	230V~, 50Hz	2300W	10A	5	Schuko (typ F)	PVC	1,0 mm ²	1,5m



Listwa zasilająca Power strip



Ładowarka USB
USB charger



PS-4/W

PS-4/(GS)W

Symbol Product no.	EAN	Napięcie nominalne Nominal voltage	Maks. obciążenie Max. load	Prąd Current	Ilość gniazd Number of sockets	Typ gniazda Socket type	Typ izolacji Insulation type	Przekrój żyły Wire cross-section	Długość przewodu Cable length	Kolor Color
PS-4/W	5908254825941	230V~, 50Hz	2300W	10A	3	Francuski (typ E) French (type E)	PVC	1 mm ²	1,4m	Biały White
PS-4(GS)/W	5908254825958	230V~, 50Hz	3680W	16A	3	Schuko (typ F)	PVC	1,5 mm ²	1,4m	Czarny Black



Wyłącznik termiczny
Thermal switch



Dwa podświetlane przyciski
dwutorowe
Two-track backlit switches

Listwa zasilająca Power strip







PS-3/B/1,5M

Symbol Product no.	EAN	Napięcie nominalne Nominal voltage	Maks. obciążenie Max. load	Prąd Current	Ilość gniazd Number of sockets	Typ gniazda Socket type	Typ izolacji Insulation type	Przekrój żyły Wire cross-section	Długość przewodu Cable length	Kolor Color
PS-3/B/1,5M	5908254823985	230V~, 50Hz	3680W	16A	10	Francuski (typ E) French (type E)	PVC	1,5 mm ²	1,5m	Biały White

Listwa przeciwprzebieciowa

Power strip with surge protection

-  Ochronnik przeciwprzebieciowy
Surge protection
-  Podświetlany przycisk dwutorowy
Two-track backlit switch
-  Ładowarka USB 2xUSB-A
USB charger 2xUSB-A
-  Długość przewodu: 3m
Cable length: 3m



OR-AE-13243/W/3M



ORAE13243(GS)/W/3M



OR-AE-13244/B/3M



ORAE13244(GS)/B/3M



OR-AE-13163/3M



OR-AE-13163/B/3M



ORAE13163(GS)/3M



ORAE13163(GS)/B/3M

Symbol Product no.	EAN	Napięcie nominalne Nominal voltage	Maks. obciążenie Max. load	Prąd Current	Ilość gniazd Number of sockets	Typ gniazda Socket type	Typ izolacji Insulation type	Przekrój żyły Wire cross-section	Kolor Color
OR-AE-13243/W/3M	5908254824548	230V~, 50Hz	2300W	10A	4	Francuski (typ E) French (type E)	PVC	1 mm ²	Biały White
OR-AE-13244/B/3M	5908254824562	230V~, 50Hz	2300W	10A	8	Francuski (typ E) French (type E)	PVC	1 mm ²	Czarny Black
OR-AE-13163/3M	5900378655749	230V~, 50Hz	2300W	10A	6	Francuski (typ E) French (type E)	PVC	1 mm ²	Biały White
OR-AE-13163/B/3M	5908254810985	230V~, 50Hz	2300W	10A	6	Francuski (typ E) French (type E)	PVC	1 mm ²	Czarny Black
ORAE13243(GS)/W/3M	5908254824555	230V~, 50Hz	3680W	16A	4	Schuko (typ F)	PVC	1,5 mm ²	Biały White
ORAE13244(GS)/B/3M	5908254824579	230V~, 50Hz	3680W	16A	8	Schuko (typ F)	PVC	1,5 mm ²	Czarny Black
ORAE13163(GS)/3M	5900378655756	230V~, 50Hz	3680W	16A	6	Schuko (typ F)	PVC	1,5 mm ²	Biały White
ORAE13163(GS)/B/3M	5908254810992	230V~, 50Hz	3680W	16A	6	Schuko (typ F)	PVC	1,5 mm ²	Czarny Black

Listwa zasilająca biurkowa z ładowarką USB

Desk power strip with USB charger



Łatwy montaż
Easy installation



Ładowarka indukcyjna
Inductive charger



Porty USB: 2x USB-A, 2xUSB-C
USB ports: 2x USB-A, 2xUSB-C



OR-AE-13249/W



OR-AE-13249(GS)/W

Symbol Product no.	EAN	Napięcie nominalne Nominal voltage	Maks. obciążenie Max. load	Prąd Current	Ilość gniazd Number of sockets	Typ gniazda Socket type	Typ izolacji Insulation type	Przekrój żyły Wire cross-section	Długość przewodu Cable length	Kolor Color
OR-AE-13249/W	5908254825644	230V~, 50Hz	3680W	16A	2	Francuski (typ E) French (type E)	PVC	1,5 mm ²	1,4m	Biały White
OR-AE-13249(GS)/W	5908254825651	230V~, 50Hz	3680W	16A	2	Schuko (typ F)	PVC	1,5 mm ²	1,4m	Biały White

Listwa zasilająca nabiurkowa z ładowarką USB

Desktop power strip with USB charger



Łatwy montaż
Easy installation



Ładowarka USB
USB charger



Porty USB: 1x USB-A, 1xUSB-C
USB ports: 1x USB-A, 1xUSB-C



OR-AE-13245/W/1,4M



ORAE13245(GS)/W/1,4M

Symbol Product no.	EAN	Napięcie nominalne Nominal voltage	Maks. obciążenie Max. load	Prąd Current	Ilość gniazd Number of sockets	Typ gniazda Socket type	Typ izolacji Insulation type	Przekrój żyły Wire cross-section	Długość przewodu Cable length	Kolor Color
OR-AE-13245/W/1,4M	5908254824821	230V~, 50Hz	3680W	16A	2	Francuski (typ E) French (type E)	PVC	1,5 mm ²	1,4m	Biały White
ORAE13245(GS)/W/1,4M	5908254824838	230V~, 50Hz	3680W	16A	2	Schuko (typ F)	PVC	1,5 mm ²	1,4m	Biały White

Gniazda meblowe wpuszczane

Flush-mounted furniture sockets



I 2,5mm **Płaski frezowany rant / Thin milled edge**



OR-GM-9032/G
OR-GM-9032(GS)/G



OR-GM-9032/B
OR-GM-9032(GS)/B



OR-GM-9032/C
OR-GM-9032(GS)/C



OR-GM-9032/GR
OR-GM-9032(GS)/GR



OR-GM-9033/G
OR-GM-9033(GS)/G



OR-GM-9033/B
OR-GM-9033(GS)/B



OR-GM-9033/W
OR-GM-9033(GS)/W



OR-GM-9033/GR
OR-GM-9033(GS)/GR



OR-GM-9033/C
OR-GM-9033(GS)/C



OR-GM-9034/G
OR-GM-9034(GS)/G



OR-GM-9034/B
OR-GM-9034(GS)/B



OR-GM-9034/C
OR-GM-9034(GS)/C



OR-GM-9034/GR
OR-GM-9034(GS)/GR



OR-GM-9035/G
OR-GM-9035(GS)/G



OR-GM-9035/B
OR-GM-9035(GS)/B

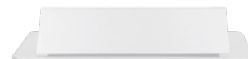

OR-GM-9035/W
OR-GM-9035(GS)/W



OR-GM-9035/GR
OR-GM-9035(GS)/GR



OR-GM-9035/C
OR-GM-9035(GS)/C

I 3mm **Płaski rant / Thin edge**



OR-GM-9036/G
OR-GM-9036(GS)/G



OR-GM-9036/B
OR-GM-9036(GS)/B



OR-GM-9037/G
OR-GM-9037(GS)/G



OR-GM-9037/B
OR-GM-9037(GS)/B

Symbol	EAN	Ilość gniazd sieciowych	Maks. obciążenie	Gniazda francuskie (typ E)	Gniazda Schuko (typ F)	Ładowarka USB	Kabel zasilający	Kolor	Wymiary (szer/wys/gł) [mm]
Product no.		Number of sockets	Max. load	French sockets (type E)	Schuko sockets (type F)	USB charger	Power cable	Color	Dimensions (W/H/D) [mm]
OR-GM-9032/G	5908254841095	3x 2P+Z 3x 2P+E	3680W	✓	-	-	-	Srebrny Silver	265 / 132 / 67,5
OR-GM-9032/B	5908254841071	3x 2P+Z 3x 2P+E	3680W	✓	-	-	-	Czarny Black	265 / 132 / 67,5
OR-GM-9032/C	5908254841088	3x 2P+Z 3x 2P+E	3680W	✓	-	-	-	Złoty Gold	265 / 132 / 67,5
OR-GM-9032/GR	5908254829130	3x 2P+Z 3x 2P+E	3680W	✓	-	-	-	Grafit Graphite	265 / 132 / 67,5
OR-GM-9032(GS)/G	5908254841064	3x 2P+Z 3x 2P+E	3680W	-	✓	-	-	Srebrny Silver	265 / 132 / 67,5
OR-GM-9032(GS)/B	5908254829123	3x 2P+Z 3x 2P+E	3680W	-	✓	-	-	Czarny Black	265 / 132 / 67,5
OR-GM-9032(GS)/C	5908254841040	3x 2P+Z 3x 2P+E	3680W	-	✓	-	-	Złoty Gold	265 / 132 / 67,5
OR-GM-9032(GS)/GR	5908254841057	3x 2P+Z 3x 2P+E	3680W	-	✓	-	-	Grafit Graphite	265 / 132 / 67,5
OR-GM-9033/G	5908254841156	3x 2P+Z 3x 2P+E	3680W	✓	-	-	1,5m	Srebrny Silver	265 / 132 / 67,5
OR-GM-9033/B	5908254841132	3x 2P+Z 3x 2P+E	3680W	✓	-	-	1,5m	Czarny Black	265 / 132 / 67,5
OR-GM-9033/W	5908254841170	3x 2P+Z 3x 2P+E	3680W	✓	-	-	1,5m	Biały White	265 / 132 / 67,5
OR-GM-9033/C	5908254841149	3x 2P+Z 3x 2P+E	3680W	✓	-	-	1,5m	Złoty Gold	265 / 132 / 67,5
OR-GM-9033/GR	5908254841163	3x 2P+Z 3x 2P+E	3680W	✓	-	-	1,5m	Grafit Graphite	265 / 132 / 67,5
OR-GM-9033(GS)/G	5908254840463	3x 2P+Z 3x 2P+E	3680W	-	✓	-	1,5m	Srebrny Silver	265 / 132 / 67,5
OR-GM-9033(GS)/B	5908254829147	3x 2P+Z 3x 2P+E	3680W	-	✓	-	1,5m	Czarny Black	265 / 132 / 67,5
OR-GM-9033(GS)/W	5908254841125	3x 2P+Z 3x 2P+E	3680W	-	✓	-	1,5m	Biały White	265 / 132 / 67,5
OR-GM-9033(GS)/C	5908254841101	3x 2P+Z 3x 2P+E	3680W	-	✓	-	1,5m	Złoty Gold	265 / 132 / 67,5
OR-GM-9033(GS)/GR	5908254841118	3x 2P+Z 3x 2P+E	3680W	-	✓	-	1,5m	Grafit Graphite	265 / 132 / 67,5
OR-GM-9034/G	5908254840951	2 x 2P+Z 2x 2P+E	3680W	✓	-	1xUSB-A, 1x USB-C 5V DC / 3,6A	-	Srebrny Silver	265 / 132 / 67,5
OR-GM-9034/B	5908254840937	2 x 2P+Z 2x 2P+E	3680W	✓	-	1xUSB-A, 1x USB-C 5V DC / 3,6A	-	Czarny Black	265 / 132 / 67,5
OR-GM-9034/C	5908254840944	2 x 2P+Z 2x 2P+E	3680W	✓	-	1xUSB-A, 1x USB-C 5V DC / 3,6A	-	Złoty Gold	265 / 132 / 67,5
OR-GM-9034/GR	5908254840968	2 x 2P+Z 2x 2P+E	3680W	✓	-	1xUSB-A, 1x USB-C 5V DC / 3,6A	-	Grafit Graphite	265 / 132 / 67,5
OR-GM-9034(GS)/G	5908254829109	2 x 2P+Z 2x 2P+E	3680W	-	✓	1xUSB-A, 1x USB-C 5V DC / 3,6A	-	Srebrny Silver	265 / 132 / 67,5
OR-GM-9034(GS)/B	5908254829093	2 x 2P+Z 2x 2P+E	3680W	-	✓	1xUSB-A, 1x USB-C 5V DC / 3,6A	-	Czarny Black	265 / 132 / 67,5
OR-GM-9034(GS)/C	5908254840913	2 x 2P+Z 2x 2P+E	3680W	-	✓	1xUSB-A, 1x USB-C 5V DC / 3,6A	-	Złoty Gold	265 / 132 / 67,5
OR-GM-9034(GS)/GR	5908254840920	2 x 2P+Z 2x 2P+E	3680W	-	✓	1xUSB-A, 1x USB-C 5V DC / 3,6A	-	Grafit Graphite	265 / 132 / 67,5
OR-GM-9035/G	5908254841019	2 x 2P+Z 2x 2P+E	3680W	✓	-	1xUSB-A, 1x USB-C 5V DC / 3,6A	1,5m	Srebrny Silver	265 / 132 / 67,5
OR-GM-9035/B	5908254829116	2 x 2P+Z 2x 2P+E	3680W	✓	-	1xUSB-A, 1x USB-C 5V DC / 3,6A	1,5m	Czarny Black	265 / 132 / 67,5
OR-GM-9035/W	5908254841033	2 x 2P+Z 2x 2P+E	3680W	✓	-	1xUSB-A, 1x USB-C 5V DC / 3,6A	1,5m	Biały White	265 / 132 / 67,5
OR-GM-9035/C	5908254841002	2 x 2P+Z 2x 2P+E	3680W	✓	-	1xUSB-A, 1x USB-C 5V DC / 3,6A	1,5m	Złoty Gold	265 / 132 / 67,5
OR-GM-9035/GR	5908254841026	2 x 2P+Z 2x 2P+E	3680W	✓	-	1xUSB-A, 1x USB-C 5V DC / 3,6A	1,5m	Grafit Graphite	265 / 132 / 67,5
OR-GM-9035(GS)/G	5908254840470	2 x 2P+Z 2x 2P+E	3680W	-	✓	1xUSB-A, 1x USB-C 5V DC / 3,6A	1,5m	Srebrny Silver	265 / 132 / 67,5
OR-GM-9035(GS)/B	5908254840487	2 x 2P+Z 2x 2P+E	3680W	-	✓	1xUSB-A, 1x USB-C 5V DC / 3,6A	1,5m	Czarny Black	265 / 132 / 67,5
OR-GM-9035(GS)/W	5908254840999	2 x 2P+Z 2x 2P+E	3680W	-	✓	1xUSB-A, 1x USB-C 5V DC / 3,6A	1,5m	Biały White	265 / 132 / 67,5
OR-GM-9035(GS)/C	5908254840975	2 x 2P+Z 2x 2P+E	3680W	-	✓	1xUSB-A, 1x USB-C 5V DC / 3,6A	1,5m	Złoty Gold	265 / 132 / 67,5
OR-GM-9035(GS)/GR	5908254840982	2 x 2P+Z 2x 2P+E	3680W	-	✓	1xUSB-A, 1x USB-C 5V DC / 3,6A	1,5m	Grafit Graphite	265 / 132 / 67,5
OR-GM-9036/G	5908254841200	3x 2P+Z 3x 2P+E	3680W	✓	-	-	-	Srebrny Silver	265 / 135 / 68
OR-GM-9036/B	5908254841194	3x 2P+Z 3x 2P+E	3680W	✓	-	-	-	Czarny Black	265 / 135 / 68
OR-GM-9036(GS)/G	5908254829154	3x 2P+Z 3x 2P+E	3680W	-	✓	-	-	Srebrny Silver	265 / 135 / 68
OR-GM-9036(GS)/B	5908254841187	3x 2P+Z 3x 2P+E	3680W	-	✓	-	-	Czarny Black	265 / 135 / 68
OR-GM-9037/G	5908254841231	3x 2P+Z 3x 2P+E	3680W	✓	-	-	1,5m	Srebrny Silver	265 / 135 / 68
OR-GM-9037/B	5908254841224	3x 2P+Z 3x 2P+E	3680W	✓	-	-	1,5m	Czarny Black	265 / 135 / 68
OR-GM-9037(GS)/G	5908254841217	3x 2P+Z 3x 2P+E	3680W	-	✓	-	1,5m	Srebrny Silver	265 / 135 / 68
OR-GM-9037(GS)/B	5908254829161	3x 2P+Z 3x 2P+E	3680W	-	✓	-	1,5m	Czarny Black	265 / 135 / 68



Gniazdo wpuszczane w blat z elektrycznym otwieraniem

Flush-mounted socket with opening mechanism



Płaski frezowany rant
Thin milled edge



Mechanizm elektrycznego otwierania
Electric opening mechanism



Gniazdo HDMI 2.0
HDMI 2.0 socket



Gniazdo sieciowe RJ45
Network socket RJ45



Materiał: aluminium + tworzywo sztuczne
Material: aluminium + plastic



Symbol Product no.	EAN	Ilość gniazd sieciowych Number of sockets	Maks. obciążenie Max. load	Typ gniazda Socket type	Dodatkowe gniazda Additional sockets	Kabel zasilający Power cable	Wymiary [mm] Dimensions [mm]
OR-GM-9038	5908254842436	3x 2P+Z 3x 2P+E	3680W	Francuski (typ E) French (type E)	2 x RJ45, 1 x HDMI	1,5m	369 / 120 / 103
OR-GM-9038(GS)	5908254842443	3x 2P+Z 3x 2P+E	3680W	Schuko (typ F)	2 x RJ45, 1 x HDMI	1,5m	369 / 120 / 103



Gniazdo wpuszczane w blat z ładowarką USB i przewodem

Flush-mounted socket with USB charger and power cable

Symbol Product no.	EAN	Ilość gniazd sieciowych Number of sockets	Maks. obciążenie Max. load	Typ gniazda Socket type	Dodatkowe gniazda Additional sockets	Kabel zasilający Power cable	Wymiary [mm] Dimensions [mm]
OR-GM-9029/B	5908254826634	1x 2P+Z 1x 2P+E	3680W	Francuski (typ E) French (type E)	2xUSB-A 5V DC / 2,1A	1,5m	137 / 134 / 68
OR-GM-9029(GS)/B	5908254826641	1x 2P+Z 1x 2P+E	3680W	Schuko (typ F)	2xUSB-A 5V DC / 2,1A	1,5m	137 / 134 / 68



Gniazda wysuwane z blatu

Pop up desk sockets



Symbol Product no.	EAN	Ilość gniazd sieciowych Number of sockets	Maks. obciążenie Max. load	Gniazda francuskie (typ E) French sockets (type E)	Gniazda Schuko (typ F) Schuko sockets (type F)	Ładowarka USB USB charger	Kabel zasilający Power cable	Kolor Color	Średnica [mm] Diameter [mm]
OR-GM-9027	5908254825606	3x 2P+Z 3x 2P+E	3680W	✓	-	1xUSB-A, 1x USB-C 5V DC / 2,4A	1,5m	Czarno-srebrny Black-silver	Ø 60
OR-GM-9027(GS)	5908254825613	3x 2P+Z 3x 2P+E	3680W	-	✓	1xUSB-A, 1x USB-C 5V DC / 2,4A	1,5m	Czarno-srebrny Black-silver	Ø 60



Gniazda wysuwane z blatu

Pop up desk sockets

Symbol Product no.	EAN	Ilość gniazd sieciowych Number of sockets	Maks. obciążenie Max. load	Gniazda francuskie (typ E) French sockets (type E)	Ładowarka USB USB charger	Kabel zasilający Power cable	Kolor Color	Średnica [mm] Diameter [mm]
FS-16	5908254826719	3x 2P+Z 3x 2P+E	3680W	✓	-	1,8m	Inox	Ø 80
FS-17	5908254826726	3x 2P+Z 3x 2P+E	3680W	✓	2xUSB-A 5V DC / 2,1A	1,8m	Czarno-srebrny Black-silver	Ø 80
FS-18	5908254840616	3x 2P+Z 3x 2P+E	3680W	✓	-	1,8m	Czarno-srebrny Black-silver	Ø 80



Gniazdo meblowe z rotacyjną pokrywą i ładowarką indukcyjną

Furniture socket
with rotative cover and inductive charger



Ładowarka indukcyjna
Inductive charger

Symbol Product no.	EAN	Ilość gniazd sieciowych Number of sockets	Maks. obciążenie Max. load	Typ gniazda Socket type	Ładowarka USB USB charger	Ładowarka indukcyjna Inductive charger	Kabel zasilający Power cable	Kolor Color	Średnica [mm] Diameter [mm]
OR-GM-9028	5908254825620	1x 2P+Z 1x 2P+E	3680W	Francuski (typ E) French (type E)	1xUSB-A, 1x USB-C 5V DC / 2,4A	Qi V1.2.4	1,5m	Czarny Black	Ø 60
OR-GM-9028(GS)	5908254825637	1x 2P+Z 1x 2P+E	3680W	Schuko (typ F)	1xUSB-A, 1x USB-C 5V DC / 2,4A	Qi V1.2.4	1,5m	Czarny Black	Ø 60



Gniazdo meblowe z przesuwającą pokrywą

Furniture socket with sliding cover



Symbol Product no.	EAN	Ilość gniazd sieciowych Number of sockets	Maks. obciążenie Max. load	Typ gniazda Socket type	Ładowarka USB USB charger	Kabel zasilający Power cable	Kolor Color	Średnica [mm] Diameter [mm]
OR-AE-13124/B	5908254828058	1x 2P+Z 1x 2P+E	2300W	Francuski (typ E) French (type E)	1xUSB-A 5V DC / 2,4A	1,9m	Czarny Black	Ø 60
OR-AE-13124(GS)/B	5908254828065	1x 2P+Z 1x 2P+E	3680W	Schuko (typ F)	1xUSB-A 5V DC / 2,4A	1,9m	Czarny Black	Ø 60



Hermetyczne gniazdo elektryczne

Hermetic flush-mounted socket



OR-GM-9030



OR-GM-9031



Materiał: stal nierdzewna
Material: stainless steel



Kąt otwarcia pokrywy: 110°
Opening angle: 110°



Stopień ochrony: IP55
Ingress protection IP55

Symbol Product no.	EAN	Ilość gniazd sieciowych Number of sockets	Maks. obciążenie Max. load	Typ gniazda Socket type	Stopień ochrony Protection level	Wymiary [mm] Dimensions [mm]
OR-GM-9030	5908254828072	1x 2P+Z 1x 2P+E	3680W	Francuski (typ E) French (type E)	IP55	Ø 95
OR-GM-9031	5908254828089	1x 2P+Z 1x 2P+E	3680W	Francuski (typ E) French (type E)	IP55	95 / 85

Gniazda meblowe nablatowe

Surface-mounted furniture sockets



FS-5



FS-6



FS-7



FS-8

Symbol Product no.	EAN	Ilość gniazd sieciowych Number of sockets	Maks. obciążenie Max. load	Gniazda francuskie (typ E) French sockets (type E)	Ładowarka USB USB charger	Kabel zasilający Power cable	Kolor Color	Wymiary (szer/wys/gł) [mm] Dimensions (W/H/D) [mm]
FS-5	5908254819322	3x 2P+Z 3x 2P+E	3680W	✓	2x USB-A 5V DC / 2,1A	1,8m	Czarno-srebrny Black-silver	210 / 82 / 77
FS-6	5908254822025	3x 2P+Z 3x 2P+E	3680W	✓	-	1,8m	Czarno-srebrny Black-silver	180 / 180 / 67
FS-7	5908254822032	3x 2P+Z 3x 2P+E	3680W	✓	2x USB-A 5V DC / 2,1A	1,8m	Czarno-srebrny Black-silver	225 / 180 / 67
FS-8	5908254822049	4x 2P+Z 4x 2P+E	3680W	✓	2x USB-A 5V DC / 2,1A	1,8m	Czarno-srebrny Black-silver	268 / 180 / 70

Gniazda meblowe podszafkowe

Under-cabinet furniture socket



Gniazdo podszafkowe

Under-cabinet socket



FS-9

Symbol Product no.	EAN	Ilość gniazd sieciowych Number of sockets	Maks. obciążenie Max. load	Gniazda francuskie (typ E) French sockets (type E)	Kabel zasilający Power cable	Stopień ochrony Protection level	Kolor Color	Wymiary (szer/wys/gł) [mm] Dimensions (W/H/D) [mm]
FS-9	5908254822056	1x 2P+Z 1x 2P+E	3680W	✓	0,5m	IP44	Srebrny Silver	66,5 / 60 / 60



Gniazda podszafkowe

Under-cabinet sockets



FS-10



FS-11

Symbol Product no.	EAN	Ilość gniazd sieciowych Number of sockets	Maks. obciążenie Max. load	Gniazda francuskie (typ E) French sockets (type E)	Kabel zasilający Power cable	Stopień ochrony Protection level	Kolor Color	Wymiary (szer/wys/gł) [mm] Dimensions (W/H/D) [mm]
FS-10	5908254822063	2x 2P+Z 2x 2P+E	3680W	✓	0,5m	IP20	Srebrny Silver	140 / 62 / 45
FS-11	5908254822070	2x 2P+Z 2x 2P+E	3680W	✓	0,5m	IP44	Srebrny Silver	140 / 62 / 45



Gniazda narożne

Corner sockets



FS-12/B



FS-13/B











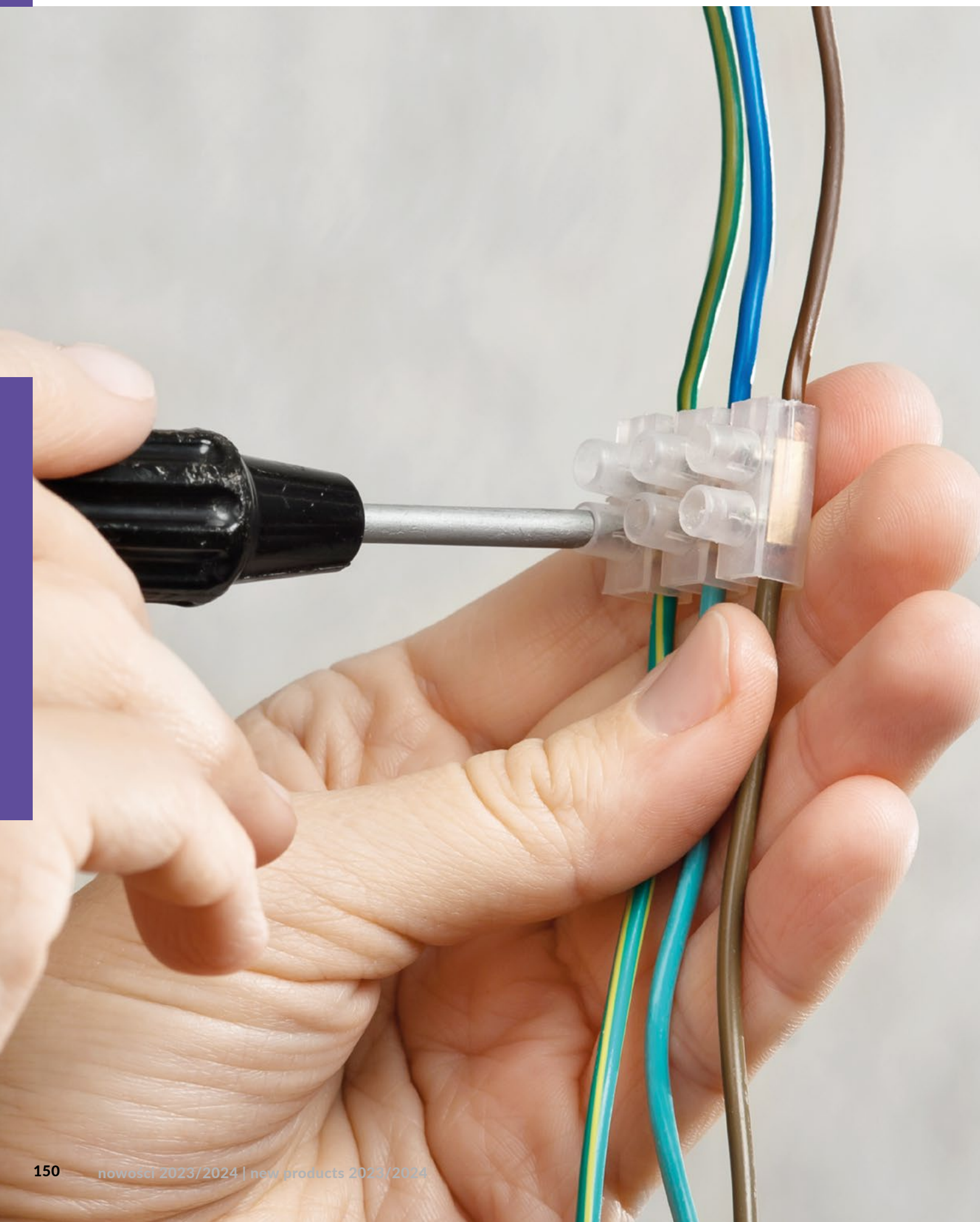

FS-14/B



FS-15/B

Symbol Product no.	EAN	Ilość gniazd sieciowych Number of sockets	Maks. obciążenie Max. load	Gniazda francuskie (typ E) French sockets (type E)	Ładowarka USB USB charger	Kabel zasilający Power cable	Stopień ochrony Protection level	Kolor Color	Wymiary (szer/wys/gł) [mm] Dimensions (W/H/D) [mm]
FS-12/B	5908254825569	2x 2P+Z 2x 2P+E	3680W	✓	-	1,5m	IP20	Czarny Black	151 / 82 / 60
FS-13/B	5908254825576	2x 2P+Z 2x 2P+E	3680W	✓	2x USB-A 5V DC / 2,4A	1,5m	IP20	Czarny Black	194 / 82 / 60
FS-14/B	5908254825583	3x 2P+Z 3x 2P+E	3680W	✓	-	1,5m	IP20	Czarny Black	194 / 82 / 60
FS-15/B	5908254825590	3x 2P+Z 3x 2P+E	3680W	✓	2x USB-A 5V DC / 2,4A	1,5m	IP20	Czarny Black	237 / 82 / 60



Model	EAN	Ilość przewodów	Materiał styków	Materiał obudowy	Klasa palności UL94	Maksymalny przekrój poprzeczny przewodu [mm]	Montaż	Kolor	Ilość sztuk w opakowaniu [szt]
Product no.		Number of wires	Conductor material	Housing material	Fire rating UL94	Max. wire cross-section [mm]	Installation	Color	Quantity per pack [pcs]
 OR-SZ-8019/4	5908254827358	12	Miedź Copper	PE	-	4	Śrubowy Screw	Transparentny Transparent	1
OR-SZ-8019/4/10	5908254827457	12	Miedź Copper	PE	-	4	Śrubowy Screw	Transparentny Transparent	10
 OR-SZ-8019/6	5908254827365	12	Miedź Copper	PE	-	6	Śrubowy Screw	Transparentny Transparent	1
OR-SZ-8019/6/10	5908254827464	12	Miedź Copper	PE	-	6	Śrubowy Screw	Transparentny Transparent	10
 OR-SZ-8019/10	5908254827372	12	Miedź Copper	PE	-	10	Śrubowy Screw	Transparentny Transparent	1
OR-SZ-8019/10/10	5908254827471	12	Miedź Copper	PE	-	10	Śrubowy Screw	Transparentny Transparent	10
 OR-SZ-8019/16	5908254827389	12	Miedź Copper	PE	-	16	Śrubowy Screw	Transparentny Transparent	1
OR-SZ-8019/16/10	5908254827488	12	Miedź Copper	PE	-	16	Śrubowy Screw	Transparentny Transparent	10
 OR-SZ-8019/25	5908254827396	12	Miedź Copper	PE	-	25	Śrubowy Screw	Transparentny Transparent	1
OR-SZ-8019/25/10	5908254827495	12	Miedź Copper	PE	-	25	Śrubowy Screw	Transparentny Transparent	10
 OR-SZ-8018/4	5908254827303	12	Miedź Copper	PoliAmid	V1	4	Śrubowy Screw	Biały White	1
OR-SZ-8018/4/10	5908254827402	12	Miedź Copper	PoliAmid	V1	4	Śrubowy Screw	Biały White	10
 OR-SZ-8018/6	5908254827310	12	Miedź Copper	PoliAmid	V1	6	Śrubowy Screw	Biały White	1
OR-SZ-8018/6/10	5908254827419	12	Miedź Copper	PoliAmid	V1	6	Śrubowy Screw	Biały White	10
 OR-SZ-8018/10	5908254827327	12	Miedź Copper	PoliAmid	V1	10	Śrubowy Screw	Biały White	1
OR-SZ-8018/10/10	5908254827426	12	Miedź Copper	PoliAmid	V1	10	Śrubowy Screw	Biały White	10
 OR-SZ-8018/16	5908254827334	12	Miedź Copper	PoliAmid	V1	16	Śrubowy Screw	Biały White	1
OR-SZ-8018/16/10	5908254827433	12	Miedź Copper	PoliAmid	V1	16	Śrubowy Screw	Biały White	10
 OR-SZ-8018/25	5908254827341	12	Miedź Copper	PoliAmid	V1	25	Śrubowy Screw	Biały White	1
OR-SZ-8018/25/10	5908254827440	12	Miedź Copper	PoliAmid	V1	25	Śrubowy Screw	Biały White	10



	Symbol Product no.	EAN	Typ Type	Ilość przewodów Number of wires	Napięcie nominalne Nominal voltage	Prąd Current	Przewody sztywne (druć) Solid core	Przewody elastyczne (linka) Flexible core	Ilość sztuk w opakowaniu [szt] Quantity per pack [pcs]
	OR-SZ-8017/2/10	5908254825330	Jednostronna One-sided	2 x (0,75-4mm ²)	450V~	32A	✓	✓	10
	OR-SZ-8017/2/B10	5908254825347	Jednostronna One-sided	2 x (0,75-4mm ²)	450V~	32A	✓	✓	10 (Blister)
	OR-SZ-8017/2/100	5908254825354	Jednostronna One-sided	2 x (0,75-4mm ²)	450V~	32A	✓	✓	100
	OR-SZ-8017/3/10	5908254825378	Jednostronna One-sided	3 x (0,75-4mm ²)	450V~	32A	✓	✓	10
	OR-SZ-8017/3/B6	5908254825385	Jednostronna One-sided	3 x (0,75-4mm ²)	450V~	32A	✓	✓	6 (Blister)
	OR-SZ-8017/3/100	5908254825392	Jednostronna One-sided	3 x (0,75-4mm ²)	450V~	32A	✓	✓	100
	OR-SZ-8017/4/10	5908254825415	Jednostronna One-sided	4 x (0,75-4mm ²)	450V~	32A	✓	✓	10
	OR-SZ-8017/4/B4	5908254825422	Jednostronna One-sided	4 x (0,75-4mm ²)	450V~	32A	✓	✓	4 (Blister)
	OR-SZ-8017/4/50	5908254825439	Jednostronna One-sided	4 x (0,75-4mm ²)	450V~	32A	✓	✓	50
	OR-SZ-8017/5/8	5908254840258	Jednostronna One-sided	5 x (0,75-4mm ²)	450V~	32A	✓	✓	8
	OR-SZ-8017/5/B4	5908254825460	Jednostronna One-sided	5 x (0,75-4mm ²)	450V~	32A	✓	✓	4 (Blister)
	OR-SZ-8017/5/50	5908254825477	Dwustronna Double-sided	5 x (0,75-4mm ²)	450V~	32A	✓	✓	50
	OR-SZ-8021/1/10	5908254841248	Dwustronna Double-sided	1 x (0,75-4mm ²)	250V~	32A	✓	✓	10
	OR-SZ-8021/1/B10	5908254829703	Dwustronna Double-sided	1 x (0,75-4mm ²)	250V~	32A	✓	✓	10 (Blister)
	OR-SZ-8021/1/100	5908254829673	Dwustronna Double-sided	1 x (0,75-4mm ²)	250V~	32A	✓	✓	100
	OR-SZ-8021/2/10	5908254841255	Dwustronna Double-sided	2 x (0,75-4mm ²)	250V~	32A	✓	✓	10
	OR-SZ-8021/2/B6	5908254829710	Dwustronna Double-sided	2 x (0,75-4mm ²)	250V~	32A	✓	✓	6 (Blister)
	OR-SZ-8021/2/50	5908254829680	Dwustronna Double-sided	2 x (0,75-4mm ²)	250V~	32A	✓	✓	50
	OR-SZ-8021/3/9	5908254841262	Dwustronna Double-sided	3 x (0,75-4mm ²)	250V~	32A	✓	✓	9
	OR-SZ-8021/3/B4	5908254829727	Dwustronna Double-sided	3 x (0,75-4mm ²)	250V~	32A	✓	✓	4 (Blister)
	OR-SZ-8021/3/50	5908254829697	Dwustronna Double-sided	3 x (0,75-4mm ²)	250V~	32A	✓	✓	50



Symbol Product no.	EAN	Ilość [szt.] Quantity [pcs]	Zawartość zestawu Elements of the set	Materiał pudełka Box material	Wymiary pudełka [mm] Box dimensions [mm]
 OR-SZ-8007	5900378659402	123	<p>Wciskane (push-in): 2x0,75-2,5mm² x 30pcs; 3x0,75-2,5mm² x 30pcs; 4x0,75-2,5mm² x 25pcs; 5x0,75-2,5mm² x 20pcs; 6x0,75-2,5mm² x 10pcs; 8x0,75-2,5mm² x 8pcs</p>	Tworzywo sztuczne Plastic	150 / 200 / 35
 OR-SZ-8009	5908254804786	109	<p>Wciskane (push-in): 2x0,75-2,5mm² x 30pcs; 3x0,75-2,5mm² x 30pcs; 5x0,75-2,5mm² x 12pcs;</p> <p>Zaciskowe (clamp): 2x0,2-4mm² x 20pcs; 3x0,2-4mm² x 12pcs; 5x0,2-4mm² x 5pcs;</p>	Tworzywo sztuczne Plastic	150 / 200 / 35
 OR-SZ-8020	5908254827877	89	<p>Zaciskowe (clamp): 2x0,2-4mm² x 32pcs; 3x0,2-4mm² x 33pcs; 4x0,2-4mm² x 13pcs; 5x0,2-4mm² x 11pcs;</p>	Tworzywo sztuczne Plastic	150 / 200 / 35

Uchwyty kablowe okrągłe

Circular cable clip



Symbol Product no.	EAN	Max. średnica kabla Max. wire diameter	Kolor Color	Ilość sztuk w opakowaniu [szt] Quantity per pack [pcs]
OR-MP-6000/4/25	5908254827136	4mm	Biały White	25
OR-MP-6000/4/100	5908254826979	4mm	Biały White	100
OR-MP-6000/5/25	5908254827143	5mm	Biały White	25
OR-MP-6000/6/25	5908254827150	6mm	Biały White	25
OR-MP-6000/6/100	5908254826993	6mm	Biały White	100
OR-MP-6000/7/25	5908254827167	7mm	Biały White	25
OR-MP-6000/7/100	5908254827006	7mm	Biały White	100
OR-MP-6000/8/25	5908254827174	8mm	Biały White	25
OR-MP-6000/8/100	5908254827013	8mm	Biały White	100
OR-MP-6000/10/25	5908254827181	10mm	Biały White	25
OR-MP-6000/10/100	5908254827020	10mm	Biały White	100
OR-MP-6000/12/25	5908254827198	12mm	Biały White	25
OR-MP-6000/12/100	5908254827037	12mm	Biały White	100

Uchwyty kablowe płaskie

Flat cable clip



Symbol Product no.	EAN	Max. szerokość kabla Max. cable width	Max. wysokość kabla Max. cable height	Kolor Color	Sugerowany typ kabla Suggested cable type	Ilość sztuk w opakowaniu [szt] Quantity per pack [pcs]
OR-MP-6001/7/5/25	5908254827242	7	5	Biały White	YDYp 2 x 1,5mm ²	25
OR-MP-6001/7/5/100	5908254827082	7	5	Biały White	YDYp 2 x 1,5mm ²	100
OR-MP-6001/8/6/25	5908254827266	8	6	Biały White	YDYp 2 x 2,5 mm ²	25
OR-MP-6001/8/6/100	5908254827105	8	6	Biały White	YDYp 2 x 2,5 mm ²	100
OR-MP-6001/10/6/25	5908254827273	10	6	Biały White	YDYp 3 x 1,5mm ²	25
OR-MP-6001/10/6/100	5908254827112	10	6	Biały White	YDYp 3 x 1,5mm ²	100
OR-MP-6001/14/6/25	5908254827280	14	6	Biały White	YDYp 3 x 2,5mm ²	25
OR-MP-6001/14/6/100	5908254827129	14	6	Biały White	YDYp 3 x 2,5mm ²	100

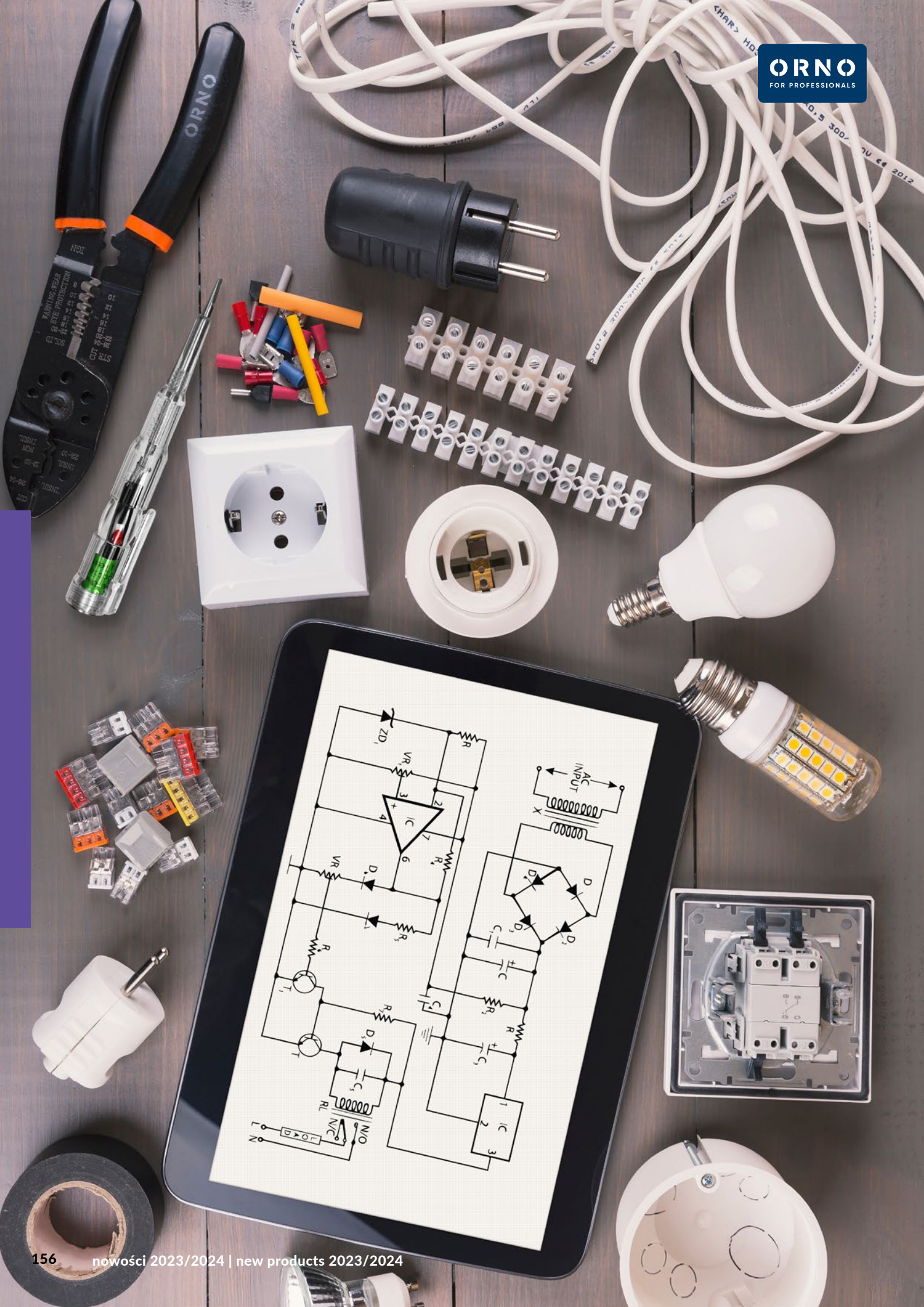

Elektroniczny próbnik napięcia 6w1

Electronic voltage tester 6in1



Sygnalizacja optyczna
Optical indicator



Płaski grot
Flat tip

Symbol Product no.	EAN	Zakres pomiaru Measurement range	Typ pomiaru Measurement type	Wymiary [mm] Dimensions [mm]
OR-AE-13275	5908254826658	70-250V	Test obecności, pomiar, indukcja, ciągłość, polaryzacja DC, wykrywanie mikrofal	20 / 138 / 17

Indukcyjny tester napięcia z latarką

Inductive voltage tester with flashlight



Sygnalizacja niskiego stanu baterii
Low battery indication



Sygnalizacja optyczna
Optical indicator



Sygnalizacja dźwiękowa
Sound indication



Funkcja latarki
Flashlight function

Symbol Product no.	EAN	Zakres pomiaru Measurement range	Typ pomiaru Measurement type	Wymiary [mm] Dimensions [mm]
OR-AE-13276	5908254826672	12-1000V	AC	25 / 158 / 21,5

Jednobiegunowy wielofunkcyjny próbnik elektryczny FAZER 777

FAZER 777 Single-pole multi-function electronic tester



Sygnalizacja dźwiękowa
Sound indication



Sygnalizacja optyczna
Optical indicator

Symbol Product no.	EAN	Zakres pomiaru Measurement range	Typ pomiaru Measurement type	Wymiary [mm] Dimensions [mm]
OR-AE-13287	5904988907991	3-500V	Test obecności, indukcja, ciągłość, polaryzacja DC	32 / 175 / 22





Produkty konsumenckie

Consumer goods

Nowości produktowe
New products

2023/2024

Adaptory podróżne

Travel adapters

VIRONE
simple made easy.



Adapter z ładowarką USB i kablem ładującym

Adapter with USB charger and charging cable



Prąd: 16A
Current: 16A



Maks. obciążenie: 3680W
Max. load: 3680W



Kabel ładujący: 0,8m
Charging cable: 0.8 m



CS-2



CS-2(GS)

Symbol Product no.	EAN	Napięcie nominalne Nominal voltage	Prąd Current	Ilość gniazd sieciowych Number of sockets	Typ gniazda Socket type	Maks. obciążenie Max. load	Ładowarka USB USB charger	Kabel ładujący Charging cable	Wymiary (szer/ wys/gł) [mm] Dimensions (W/H/D) [mm]
CS-2	5908254827990	230V~, 50Hz	16A	1x 2P+Z 1x 2P+E	francuski (typ E) french (type E)	3680W	1x USB A, 1x USB C 5V DC / 3,4A	USB-C + lightning	59 / 107 / 70
CS-2(GS)	5908254828003	230V~, 50Hz	16A	1x 2P+Z 1x 2P+E	Schuko (typ F)	3680W	1x USB A, 1x USB C 5V DC / 3,4A	USB-C + lightning	59 / 107 / 70

Adapter podróżny

Travel adapter



TA-5

TA-7

TA-8

Symbol Product no.	EAN	Napięcie nominalne Nominal voltage	Prąd Current	Typ gniazda Socket type	Maks. obciążenie Max. load	Standard wtyczki Standard of the plug	Wymiary (szer./wys./gł.) [mm] Dimensions (W/H/D) [mm]
TA-5	5908254826566	230V~, 50Hz	13A	Uniwersalne Universal	2990W	Uni-Schuko	53 / 47 / 45
TA-7	5908254828423	230V~, 50Hz	13A	Uniwersalne Universal	2990W	Typ G	53 / 47 / 49
TA-8	5908254828430	110-230V~, 50Hz	10A	Uniwersalne Universal	2300W	Typ A/B	53 / 47 / 45

GOworld uniwersalny adapter podróżny

GOworld multiple destinations travel adapter



TA-1

TA-6

Symbol Product no.	EAN	Napięcie nominalne Nominal voltage	Maks. obciążenie Max. load	Typ gniazda Socket type	Ładowarka USB USB charger	Standard wtyczki Standard of the plug	Wymiary (szer./wys./gł.) [mm] Dimensions (W/H/D) [mm]
TA-1	5908254820793	110-240V~, 50/60Hz	880W (110~) 1840W (230V~)	Uniwersalne Universal	-	AUS, BE/DE/NL/RU, BE/DE/NL/RU/CH, CH, FR, UK/HK, USA/CA/CN, USA/CA/CN	55 / 52 / 53
TA-6	5908254828676	110-240V~, 50/60Hz	880W (110~) 1840W (230V~)	Uniwersalne Universal	2x USB-A 5V DC 2.4A	AUS, BE/DE/NL/RU, BE/DE/NL/RU/CH, CH, FR, UK/HK, USA/CA/CN, USA/CA/CN	55 / 68 / 53

Skrzynki pocztowe

Mailboxes

VIRONE
simple made easy.



Samoa

Przelotowa skrzynka na listy
Pass-through mailbox



MB-4/G

Palawan

Skrzynka na listy z gazetnikiem
Mailbox with newspaper holder



MB-6/A

Symbol Product no.	EAN	Materiał Material	Kolor Color	Wymiary (szer./wys./gt.) [mm] Dimensions (W/H/D) [mm]
MB-4/G	5904988905409	Stal nierdzewna Stainless steel	Inox	300 / 110 / 405
MB-6/A	5908254829208	Stal galwanizowana Galvanised steel	Antracyt Anthracite	370 / 370 / 115



Fiji

Przelotowa skrzynka na listy
Pass-through mailbox



MB-5/A



MB-5/B



MB-5/BR

Symbol Product no.	EAN	Materiał Material	Kolor Color	Wymiary (szer./wys./gł.) [mm] Dimensions (W/H/D) [mm]
MB-5/A	5904988905423	Stal galwanizowana Galvanised steel	Antracyt Anthracite	295 / 400 / 120
MB-5/B	5904988905416	Stal galwanizowana Galvanised steel	Czarny Black	295 / 400 / 120
MB-5/BR	5904988906024	Stal galwanizowana Galvanised steel	Brązowy Brown	295 / 400 / 120

Uchwyty TV

TV mounts

Uchwyty ścienne do telewizorów

TV wall mounts



MH-1



MH-2



MH-3

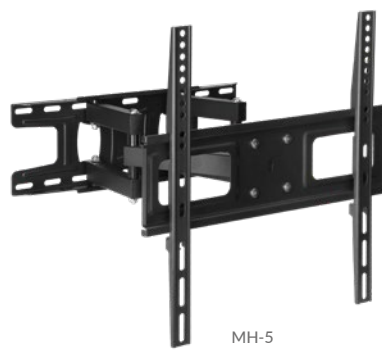

MH-5

Symbol Product no.	EAN	Obsługiwana wielkość ekranu Supported screen size	Kompatybilność z VESA VESAs compatibility	Regulacja nachylenia Tilt adjust- ment	Obrót ramienia Arm motion	Obrót ekranu Screen rotation	Odległość od ściany [mm] Distance from the wall [mm]	Max. udźwig [kg] Max. load [kg]	Materiał Material
MH-1	5904988907335	32" - 55"	75x75 ~ 400x400	0° / -10°	X	X	27	30	Stal Steel
MH-2	5904988907342	26" - 55"	75x75 ~ 400x400	+5° / -12°	180°	±90°	61-348	25	Stal Steel
MH-3	5904988907359	32" - 60"	200x100 ~ 400x400	+2° / -12°	X	±45°	56-465	30	Stal Steel
MH-5	5904988907373	32" - 55"	100x100 ~ 400x400	+8° / -12°	X	±60°	57-367	35	Stal Steel

Uchwyty biurkowe do monitorów

Monitor arms

ViRONE
simple made easy.



MH-4



MH-F80



MH-F160

Symbol Product no.	EAN	Grubość blatu [mm] Worktop thickness [mm]	Obsługiwana wielkość ekranu Supported screen size	Kompatybilność z VESA VESA compatibility	Regulacja nachylenia Tilt adjustment	Obrót ekranu Screen rotation	Obrót ramienia Arm motion	Funkcja PIVOT PIVOT function	Regulacja wysokości ekranu [mm] Screen height adjustment [mm]	Max. udźwig [kg] Max. load [kg]	Materiał Material
MH-4	5904988907366	10-100	2x 13" - 27"	75x75 mm, 100x100	+90° / -90°	±90°	180°	±90°	200-430	20 (2x10)	Stal Steel
MH-F80	5904988907380	10-90	17" - 30"	75x75 ~ 100x100	+85° / -30°	180°	360°	360°	150-400	9	Stal Steel
MH-F160	5904988907397	10-90	2x 17" - 27"	75x75 ~ 100x100	+85° / -30°	180°	360°	360°	150-400	18 (2x9)	Stal Steel

Maskownice kabli

Cable cover



Symbol Product no.	EAN	Długość [mm] Length [mm]	Szerokość/głębokość [mm] Width/depth [mm]	Kolor Color
MH-MASK110/B	5904988907403	1100	60 / 20	Czarny Black
MH-MASK110/W	5904988907410	1100	60 / 20	Biały White

Złączki antenowe

Antennae connectors



ZA-2/2



ZA-3/S/2



ZA-1/10



ZA-1/S/10



ZA-4



ZA-13



ZA-11



ZA-5



ZA-14



ZA-16



ZA-18



ZA-15



ZA-19



ZA-17



ZA-6



ZA-7



ZA-8



ZA-9



ZA-12/W/1,8M



ZA-12/W/5M

Symbol Product no.	EAN	Model Model	Rodzaj złącza Connector type	Rodzaj styku Contact type	Materiał Material	Inne	Ilość sztuk w opakowaniu [szt] Quantity per pack [pcs]
ZA-2/2	5904988908400	Wtyk SAT-F SAT-F connector	F	Męski Male	Miedź Copper		2
ZA-3/S/2	5904988908424	Wtyk SAT-F SAT-F connector	F	Męski Male	Metal		2
ZA-1/10	5904988908363	Wtyk SAT-F SAT-F connector	F	Męski Male	Miedź Copper		10
ZA-1/S/10	5904988908387	Wtyk SAT-F SAT-F connector	F	Męski Male	Miedź Copper		10
ZA-4	5904988908431	Gniazdo antenowe Aerial socket	-	Męski Male	Metal		1
ZA-13	5904988908554	Gniazdo antenowe kątowe Angled aerial socket	-	Męski Male	Metal		1
ZA-11	5904988908509	Złącze kabli TV (beczka) TV cable connector (barrel)	-	Męski Male	Tworzywo sztuczne Plastic		1
ZA-5	5904988908448	Wtyk-TV/Gniazdo SAT-F TV connector/F-socket	F	Męski Male	Tworzywo sztuczne Plastic		1
ZA-14	5904988908561	Wtyk-TV/Wtyk-F TV-plug / F-plug	F	Męski Male	Miedź Copper		1
ZA-16	5904988908585	Gniazdo-TV/Gniazdo-F TV-socket / F-socket	F	Żeński Female	Metal		1
ZA-18	5904988908608	Gniazdo-TV/Wtyk-F TV-socket/F-plug	F	Męski/żeński Male/Female	Miedź Copper		1
ZA-15	5904988908578	Wtyk-F/Gniazdo-F kątowe F-plug / F-angle-socket	F	Męski/żeński Male/Female	Metal		1
ZA-19	5904988908615	Wtyk BNC/ gniazdo-F BNC-plug / F-socket	F	Męski/żeński Male/Female	Metal		1
ZA-17	5904988908592	Terminator SAT-F	F	Męski Male	Tworzywo sztuczne Plastic		1
ZA-6	5904988908455	Trójnik "T", wtyk/2x gniazdo T-connector, plug / 2x socket	-	Męski/żeński Male/Female	Tworzywo sztuczne Plastic		1
ZA-7	5904988908462	Trójnik "T", gniazdo/2x wtyk T-connector, socket/2x plug	-	Męski/żeński Male/Female	Tworzywo sztuczne Plastic		1
ZA-8	5904988908479	Trójnik "T", wtyk/2x gniazdo T-connector, plug / 2x socket	-	Męski/żeński Male/Female	Tworzywo sztuczne Plastic		1
ZA-9	5904988908486	Trójnik "T", gniazdo/2x wtyk T-connector, socket/2x plug	-	Męski/żeński Male/Female	Tworzywo sztuczne Plastic		1
ZA-12/W/1,8M	5904988908523	Kabel TV-VIDEO TV-VIDEO cable	-	Męski/żeński Male/Female	Tworzywo sztuczne Plastic	1,8m	
ZA-12/W/5M	5904988908530	Kabel TV-VIDEO TV-VIDEO cable	-	Męski/żeński Male/Female	Tworzywo sztuczne Plastic	5m	
ZA-10	5904988908493	Kabel okienny SAT-F gniazdo-gniazdo Windows antenna cable adapter, socket-F / socket-F	F	Żeński Female	Tworzywo sztuczne Plastic	0,22m	1

AD-LD-6259BE27M	50	AD-LD-6377BE27D	57	AD-LD-6438W-CE27SM	58
AD-LD-6260WE27M	50	AD-LD-6378BE27D	57	AD-LD-6439B-CE27SM	58
AD-LD-6261BE27M	50	AD-LD-6379BE27M	57	AD-LD-6439BE27SM	58
AD-LD-6263BE27M	50	AD-LD-6380BE27D	57	AD-LD-6439CE27SM	58
AD-LD-6264BE27M	50	AD-LD-6381BE27D	57	AD-LD-6439GGE27SM	58
AD-LD-6339BE27T	63	AD-LD-6382BE27D	43	AD-LD-6439W-CE27SM	58
AD-LD-6339GE27T	63	AD-LD-6383BE27D	43	AD-LD-6440BE27	59
AD-LD-6339GNE27T	63	AD-LD-6384BE27D	43	AD-LD-6441BE27	59
AD-LD-6339WE27T	63	AD-LD-6385BE27M	45	AD-LD-6441CE27	59
AD-LD-6339YE27T	63	AD-LD-6386BE27M	45	AD-LD-6441GGE27	59
AD-LD-6340BE27T	63	AD-LD-6387BE27M	45	AD-LD-6442BE27	59
AD-LD-6340GE27T	63	AD-LD-6388BE27M	45	AD-LD-6442CE27	59
AD-LD-6340GNE27T	63	AD-LD-6389BE27M	45	AD-LD-6442GGE27	59
AD-LD-6340WE27T	63	AD-LD-6390BE27M	45	AD-LD-6443BE27T	61
AD-LD-6340YE27T	63	AD-LD-6391BE27M	45	AD-LD-6444BE27T	61
AD-LD-6341BE27T	49	AD-LD-6392BE27M	45	AD-LD-6445BE27T	61
AD-LD-6341GE27T	49	AD-LD-6393BE27M	45	AD-LD-6446BE27T	61
AD-LD-6341GNE27T	49	AD-LD-6394BE27M	45	AD-LD-6447BE27T	61
AD-LD-6341WE27T	49	AD-LD-6395BE27M	45	AD-LD-6448BE27T	61
AD-LD-6341YE27T	49	AD-LD-6396BE27M	45	AD-LD-6449BE27T	61
AD-LD-6342BE27T	66	AD-LD-6397BE27M	45	AD-LD-6450BE27T	61
AD-LD-6342GNE27T	66	AD-LD-6398BE27M	45	AD-LD-6451BE27T	61
AD-LD-6342WE27T	66	AD-LD-6399BE27M	55	AD-LD-6452BE27T	61
AD-LD-6342YE27T	66	AD-LD-6400BE27M	55	AD-LD-6453BE27T	64
AD-LD-6343WE27T	64	AD-LD-6401BE27M	55	AD-LD-6454BE27T	64
AD-LD-6345WE27M	50	AD-LD-6402BE27M	55	AD-LD-6455BE27T	64
AD-LD-6350BE27M	51	AD-LD-6403BE27M	55	AD-LD-6456BE27T	66
AD-LD-6351BE27M	51	AD-LD-6404BE27D	46	AD-LD-6457B-CE27T	66
AD-LD-6352BE27M	51	AD-LD-6405BE27D	46	AD-LP-6502B/2M	91
AD-LD-6353BE27M	51	AD-LD-6406BE27D	46	AD-LP-6502B/2M/50	91
AD-LD-6354BE27T	52	AD-LD-6407BE27D	55	AD-LP-6502BEC	93
AD-LD-6355BE27T	52	AD-LD-6408BE27D	55	AD-LP-6502BEC/50	93
AD-LD-6356BE27T	52	AD-LD-6409BE27D	55	AD-LP-6502G/2M	91
AD-LD-6357BE27T	52	AD-LD-6410BE27D	55	AD-LP-6502G/2M/50	91
AD-LD-6358BE27	53	AD-LD-6411BE27D	53	AD-LP-6502MC	93
AD-LD-6359BE27	53	AD-LD-6412BE27D	53	AD-LP-6502MC/50	93
AD-LD-6360BE27	53	AD-LD-6413BE27D	53	AD-LP-6502PB/2M	92
AD-LD-6361BE27T	54	AD-LD-6414BE27SW	52	AD-LP-6502PB/2M/50	92
AD-LD-6362BE27T	54	AD-LD-6415BE27SW	52	AD-LP-6502PM/2M	92
AD-LD-6364BE27T	54	AD-LD-6416BE27SW	52	AD-LP-6502PM/2M/50	92
AD-LD-6365BE27T	54	AD-LD-6417BE27SW	52	AD-LP-6502PP/2M	92
AD-LD-6366BE27M	43	AD-LD-6418BE27SW	47	AD-LP-6502PP/2M/50	92
AD-LD-6367BE27M	43	AD-LD-6419BE27SW	47	AD-LP-6502WEC	93
AD-LD-6368BE27M	43	AD-LD-6420BE27SW	47	AD-LP-6502WEC/50	93
AD-LD-6369BE27M	43	AD-LD-6421BE27SW	47	AD-LP-6503G/2M	91
AD-LD-6370BE27M	43	AD-LD-6422BE27SW	47	AD-LP-6503G/2M/50	91
AD-LD-6371BE27M	43	AD-LD-6423BE27SW	47	AD-LP-6503GEC	93
AD-LD-6372BE27M	43	AD-LD-6424BE27SW	47	AD-LP-6503GEC/50	93
AD-LD-6373BE27M	54	AD-LD-6438B-CE27SM	58	AD-LP-6503PB/2M	92
AD-LD-6374BE27M	54	AD-LD-6438BE27SM	58	AD-LP-6503PB/2M/50	92
AD-LD-6375BE27M	54	AD-LD-6438CE27SM	58	AD-LP-6503PM/2M	92
AD-LD-6376BE27M	54	AD-LD-6438GGE27SM	58	AD-LP-6503PM/2M/50	92

AD-LP-6503PP/2M	92	AD-LP-6507PM/2M	92	AD-OP-6279WGU10	36
AD-LP-6503PP/2M/50	92	AD-LP-6507PM/2M/50	92	AD-OP-6348BGU10	37
AD-LP-6504G/2M	91	AD-LP-6507PP/2M	92	AD-OP-6348WGU10	36
AD-LP-6504G/2M/50	91	AD-LP-6507PP/2M/50	92	AD-OP-6429BE27	41
AD-LP-6504GEC	93	AD-NL-6462BL4	74	AD-OP-6429WE27	40
AD-LP-6504GEC/50	93	AD-NL-6462BLR4	75	AD-OP-6430BE27	41
AD-LP-6504PB/2M	92	AD-NL-6463BL4	74	AD-OP-6430WE27	40
AD-LP-6504PB/2M/50	92	AD-NL-6463BLR4	75	AD-OP-6431BE27	41
AD-LP-6504PM/2M	92	AD-NL-6464BL4	74	AD-OP-6431WE27	40
AD-LP-6504PM/2M/50	92	AD-NL-6464BLR4	75	AD-OP-6432BE27	41
AD-LP-6504PP/2M	92	AD-NL-6465BL4	74	AD-OP-6432WE27	40
AD-LP-6504PP/2M/50	92	AD-NL-6465BLR4	75	AD-OP-6433BE27	41
AD-LP-6505B/2M	91	AD-NR-6247L6	79	AD-OP-6433WE27	40
AD-LP-6505B/2M/50	91	AD-NR-6466L4	79	AD-OP-6434BE27	41
AD-LP-6505BEC	93	AD-OL-6099CN	35	AD-OP-6434WE27	40
AD-LP-6505BEC/50	93	AD-OL-6425LZM4	35	AD-OP-6435BE27	41
AD-LP-6505G/2M	91	AD-OL-6425LZM4/PZ	35	AD-OP-6435WE27	40
AD-LP-6505G/2M/50	91	AD-OL-6426LZM4	35	AD-OP-6436BE27	41
AD-LP-6505PB/2M	92	AD-OL-6426LZM4/PZ	35	AD-OP-6436WE27	40
AD-LP-6505PB/2M/50	92	AD-OL-6427LZM4	35	AD-OP-6478BGU10	39
AD-LP-6505PM/2M	92	AD-OL-6427LZM4/PZ	35	AD-OP-6478WGU10	39
AD-LP-6505PM/2M/50	92	AD-OL-6428LZM4	35	AD-OP-6479BGU10	39
AD-LP-6505PP/2M	92	AD-OL-6428LZM4/PZ	35	AD-OP-6479WGU10	39
AD-LP-6505PP/2M/50	92	AD-OL-6458PZ	35	AD-OP-6480BGU10	39
AD-LP-6505WEC	93	AD-OM-6473L4/G	69	AD-OP-6480WGU10	39
AD-LP-6505WEC/50	93	AD-OM-6474L4/B	69	AD-OP-6481BGU10	39
AD-LP-6506B/2M	91	AD-OM-6474L4/B/USB	69	AD-OP-6481WGU10	39
AD-LP-6506B/2M/50	91	AD-OM-6474L4/G	69	AD-OP-6482BGU10	39
AD-LP-6506BEC	93	AD-OM-6474L4/G/USB	69	AD-OP-6482WGU10	39
AD-LP-6506BEC/50	93	AD-OM-6475L4/B	69	AD-OP-6483BGU10	39
AD-LP-6506G/2M	91	AD-OM-6475L4/G	69	AD-OP-6483WGU10	39
AD-LP-6506G/2M/50	91	AD-OM-6476L4/B	69	AD-OP-6484BGU10	39
AD-LP-6506MC	93	AD-OM-6476L4/B/SW	69	AD-OP-6484WGU10	39
AD-LP-6506MC/50	93	AD-OM-6476L4/G	69	AD-OP-6485BGU10	39
AD-LP-6506PB/2M	92	AD-OM-6476L4/G/SW	69	AD-OP-6485WGU10	39
AD-LP-6506PB/2M/50	92	AD-OM-6477L4/B	69	AD-OP-6486BGU10	39
AD-LP-6506PM/2M	92	AD-OM-6477L4/G	69	AD-OP-6486WGU10	39
AD-LP-6506PM/2M/50	92	AD-OP-6116BLPMR4	77	AD-PL-6459WLZM4	29
AD-LP-6506PP/2M	92	AD-OP-6193BGU10	37	AD-PL-6459WLZMM4	33
AD-LP-6506PP/2M/50	92	AD-OP-6193WGU10	36	AD-PL-6460WLZM4	29
AD-LP-6506WEC	93	AD-OP-6194BGU10	37	AD-PL-6460WLZMM4	33
AD-LP-6506WEC/50	93	AD-OP-6194WGU10	36	AD-PL-6461WLZM4	29
AD-LP-6507B/2M	91	AD-OP-6195BGU10	37	AD-PL-6461WLZMM4	33
AD-LP-6507B/2M/50	91	AD-OP-6195WGU10	36	AD-PL-6468WLPM4	29
AD-LP-6507BEC	93	AD-OP-6210L4	79	AD-PL-6468WLPMM4	33
AD-LP-6507BEC/50	93	AD-OP-6248BGU10	37	AD-PL-6469WLPM4	29
AD-LP-6507G/2M	91	AD-OP-6248WGU10	36	AD-PL-6469WLPMM4	33
AD-LP-6507G/2M/50	91	AD-OP-6277BGU10	37	AD-PL-6470WLPM4	29
AD-LP-6507GEC	93	AD-OP-6277WGU10	36	AD-PL-6471WLPM4	29
AD-LP-6507GEC/50	93	AD-OP-6278BGU10	37	AD-PL-6472WLPM4	29
AD-LP-6507PB/2M	92	AD-OP-6278WGU10	36	AD-SL-6467BLR4	76
AD-LP-6507PB/2M/50	92	AD-OP-6279BGU10	37	AD-TL-6486L3	82

AD-TL-6486L4	82	AD-TL-6501	86	ES-4(GS)/W/1,5	133
AD-TL-6486L6	82	AD-TL-6501/RGB	86	ES-4(GS)/W/3	133
AD-TL-6487L3	82	AD-TL-6501/RGBW	86	ES-4(GS)/W/5	133
AD-TL-6487L4	82	CD-2/G	20	ES-4/W/1,5	131
AD-TL-6487L6	82	CD-3/B	20	ES-4/W/3	131
AD-TL-6488L3	82	CD-3/G	20	ES-4/W/5	131
AD-TL-6488L4	82	CD-4	20	ES-5/B/1,5	131
AD-TL-6488L6	82	CD-6	20	ES-5/B/3	131
AD-TL-6489L3	82	CD-7	20	ES-5/B/5	131
AD-TL-6489L4	82	CDL-1/B	18	ES-5(GS)/B/1,5	133
AD-TL-6489L6	82	CL/2XE27-8	26	ES-5(GS)/B/3	133
AD-TL-6490LRGB	82	CL/2XE27-10/B	26	ES-5(GS)/B/5	133
AD-TL-6491L3	83	CL/2XE27-10/G	26	ES-5(GS)/W/1,5	133
AD-TL-6491L4	83	CL/2XE27-10MV/B	30	ES-5(GS)/W/3	133
AD-TL-6491L6	83	CL/2XE27-10MV/G	30	ES-5(GS)/W/5	133
AD-TL-6492L3	83	CL/2XE27-10MV/W	30	ES-5/W/1,5	131
AD-TL-6492L4	83	CL/2XE27-10/W	26	ES-5/W/3	131
AD-TL-6492L6	83	CL/2XE27-11	26	ES-5/W/5	131
AD-TL-6493LRGBW	83	CL/2XE27R-2	30	ES-6/B/1,5	131
AD-TL-6494LRGBW	83	CL/2XE27R-9	30	ES-6/B/3	131
AD-TL-6495L3	84	CS-2	160	ES-6/B/5	131
AD-TL-6495L4	84	CS-2(GS)	160	ES-6(GS)/B/1,5	133
AD-TL-6495L6	84	DB-5	8	ES-6(GS)/B/3	133
AD-TL-6496RGB	84	DB-6/B	11	ES-6(GS)/B/5	133
AD-TL-6497/DIMM	87	DL-12/B	67	ES-6(GS)/W/1,5	133
AD-TL-6497/P-S	87	DL-12/BR	67	ES-6(GS)/W/3	133
AD-TL-6497/S-R	87	DL-13/B	67	ES-6(GS)/W/5	133
AD-TL-6497/T-S	87	DL-13/W	67	ES-6/W/1,5	131
AD-TL-6498/25M	89	DL-14/B	67	ES-6/W/3	131
AD-TL-6498/RGB/25M	89	DL-14/W	67	ES-6/W/5	131
AD-TL-6498/RGBW/25M	89	DS-2	73	ES-7/B/1,5	131
AD-TL-6499/G-Z	89	DS-3	73	ES-7/B/3	131
AD-TL-6499/W-Z	89	DS-4	73	ES-7/B/5	131
AD-TL-6499/Z	88	DS-5	72	ES-7(GS)/B/1,5	133
AD-TL-6499/Z/L	89	DS-6	72	ES-7(GS)/B/3	133
AD-TL-6499/Z/L/RGB	89	DS-7	72	ES-7(GS)/B/5	133
AD-TL-6499/Z/L/RGBW	89	EM-4	109	ES-7(GS)/W/1,5	133
AD-TL-6499/Z-P	88	EM-4/B	109	ES-7(GS)/W/3	133
AD-TL-6499/Z-P/RGB	88	EM-5	109	ES-7(GS)/W/5	133
AD-TL-6499/Z-P/RGBW	88	ES-1/B/1,5M	131	ES-7/W/1,5	131
AD-TL-6499/Z-P-Z	88	ES-1/B/3M	131	ES-7/W/3	131
AD-TL-6499/Z-P-Z/RGB	88	ES-1(GS)/B/1,5M	133	ES-7/W/5	131
AD-TL-6499/Z-P-Z/RGBW	88	ES-1(GS)/B/3M	133	FS-5	146
AD-TL-6499/Z/RGB	88	ES-2/W/1,4M	131	FS-6	146
AD-TL-6499/Z/RGBW	88	ES-3	114	FS-7	146
AD-TL-6499/Z/T	89	ES-3(GS)	114	FS-8	146
AD-TL-6499/Z/T/RGB	89	ES-4/B/1,5	131	FS-9	147
AD-TL-6499/Z/T/RGBW	89	ES-4/B/3	131	FS-10	148
AD-TL-6500/P11	87	ES-4/B/5	131	FS-11	148
AD-TL-6500/P17	87	ES-4(GS)/B/1,5	133	FS-12/B	149
AD-TL-6500/P24	87	ES-4(GS)/B/3	133	FS-13/B	149
AD-TL-6500/P40	87	ES-4(GS)/B/5	133	FS-14/B	149

FS-15/B	149	LH/E27-20/B/PZ	95	OR-AE-13179/W/B	112
FS-16	142	LH/E27-20/B/PZ/50	95	OR-AE-13179/W/W	112
FS-17	142	LH/E27-20/W/PZ	95	OR-AE-13181/B	111
FS-18	142	LH/E27-20/W/PZ/50	95	OR-AE-13181/W	111
LD-8/3M/RGB/SET	85	LH/E27-27/B/PZ	95	OR-AE-13228	127
LD-8/5M/RGB/SET	85	LH/E27-27/W/PZ	95	OR-AE-13229	127
LD-9/5M/3	85	LH/E27/E14-6	95	OR-AE-13230	127
LD-9/5M/4	85	LH/E27/GU10-13	95	OR-AE-13238	114
LD-9/5M/6	85	LH/E40/E27-28	95	OR-AE-13238(GS)	114
LD-10/5M/3	85	LH/GU10/E27-23	95	OR-AE-13239	114
LD-10/5M/4	85	LH/GZ10-1	94	OR-AE-13239(GS)	114
LD-10/5M/6	85	LS-1/B	65	OR-AE-13240	114
LD-11/5M/3	85	LS-1/W	65	OR-AE-13240(GS)	114
LD-11/5M/4	85	LS-2/B	65	OR-AE-13241/B	111
LD-11/5M/6	85	LS-2/G	65	OR-AE-13241/W	111
LD-12/5M/3	85	LS-2/W	65	OR-AE-13242/B	111
LD-12/5M/4	85	LT-7	81	OR-AE-13242/W	111
LD-12/5M/6	85	LT-8	81	ORAE13243(GS)/W/3M	136
LD-13/5M/RGB	85	LT-9	81	OR-AE-13243/W/3M	136
LG-1/5M/E27/3	77	LT-10	81	OR-AE-13244/B/3M	136
LG-1/10M/E27/3	77	LT-12	80	ORAE13244(GS)/B/3M	136
LG-1/15M/E27/3	77	LT-13/B	81	ORAE13245(GS)/W/1,4M	137
LG-1/20M/E27/3	77	LT-13/BL	81	OR-AE-13245/W/1,4M	137
LG-2/5M/E27/3	77	LT-14	81	OR-AE-13246(GS)	114
LG-2/20M/E27/3	77	MB-4/G	162	OR-AE-13249(GS)/W	137
LH/E14-1/B	94	MB-5/A	163	OR-AE-13249/W	137
LH/E14-1/B/40	94	MB-5/B	163	OR-AE-13250(GS)	114
LH/E14-1/W	94	MB-5/BR	163	OR-AE-13251	114
LH/E14-1/W/40	94	MB-6/A	162	OR-AE-13252	114
LH/E14-2/B	94	MH-1	164	OR-AE-13253/B	111
LH/E14-2/B/40	94	MH-2	164	OR-AE-13253/W	111
LH/E14-2/W	94	MH-3	164	OR-AE-13254(GS)	114
LH/E14-2/W/40	94	MH-4	165	OR-AE-13255	114
LH/E14/E27-5	95	MH-5	164	OR-AE-13256	129
LH/E14/GU10-14	95	MH-F80	165	OR-AE-13256/24	129
LH/E27-1/B	94	MH-F160	165	OR-AE-13257	128
LH/E27-1/B/40	94	MH-MASK110/B	165	OR-AE-13257/12	128
LH/E27-1/W	94	MH-MASK110/W	165	OR-AE-13257(GS)	128
LH/E27-1/W/40	94	OR-AE-1384	127	OR-AE-13257(GS)/12	128
LH/E27-2/B	94	OR-AE-1385	127	OR-AE-13258	128
LH/E27-2/B/40	94	OR-AE-1386	127	OR-AE-13258/12	128
LH/E27-2/W	94	OR-AE-1387	127	OR-AE-13258(GS)	128
LH/E27-2/W/40	94	OR-AE-13124/B	144	OR-AE-13258(GS)/12	128
LH/E27/2XE27-15	95	OR-AE-13124(GS)/B	144	OR-AE-13259	129
LH/E27/2XE27-16	95	OR-AE-13163/3M	136	OR-AE-13259/24	129
LH/E27-3	94	OR-AE-13163/B/3M	136	OR-AE-13260/B	111
LH/E27-3/20	94	ORAE13163(GS)/3M	136	OR-AE-13260/W	111
LH/E27/3XE27-17	95	ORAE13163(GS)/B/3M	136	OR-AE-13261/B	111
LH/E27/3XE27-18	95	OR-AE-13179/G/B	112	OR-AE-13261/W	111
LH/E27-4	94	OR-AE-13179/G/W	112	OR-AE-13262(GS)/W	115
LH/E27-4/20	94	OR-AE-13179/R/B	112	OR-AE-13262/W	115
LH/E27/4XE27-19	95	OR-AE-13179/R/W	112	OR-AE-13263(GS)/W	115

OR-AE-13263/W	115	OR-GM-9028	143	OR-LZ-8206/4/2,5	107
OR-AE-13264(GS)/W	115	OR-GM-9028(GS)	143	OR-LZ-8206/4/2,5/150	107
OR-AE-13264/W	115	OR-GM-9029/B	141	OR-LZ-8206/4/4	107
OR-AE-13265(GS)/W	115	OR-GM-9029(GS)/B	141	OR-LZ-8206/4/4/50	107
OR-AE-13265/W	115	OR-GM-9030	145	OR-LZ-8206/4/10	107
OR-AE-13266(GS)/W	115	OR-GM-9031	145	OR-LZ-8206/4/10/25	107
OR-AE-13266/W	115	OR-GM-9032/B	139	OR-LZ-8206/4/16	107
OR-AE-13267(GS)/W	115	OR-GM-9032/C	139	OR-LZ-8206/4/16/10	107
OR-AE-13267/W	115	OR-GM-9032/G	139	OR-LZ-8206/5/2,5	107
OR-AE-13268(GS)/W	115	OR-GM-9032/GR	139	OR-LZ-8206/5/2,5/100	107
OR-AE-13268/W	115	OR-GM-9032(GS)/B	139	OR-LZ-8206/5/4	107
OR-AE-13269(GS)/W	115	OR-GM-9032(GS)/C	139	OR-LZ-8206/5/4/50	107
OR-AE-13269/W	115	OR-GM-9032(GS)/G	139	OR-LZ-8206/5/10	107
OR-AE-13270(GS)/W	114	OR-GM-9032(GS)/GR	139	OR-LZ-8206/5/10/25	107
OR-AE-13270/W	114	OR-GM-9033/B	139	OR-LZ-8206/5/16	107
OR-AE-13275	157	OR-GM-9033/C	139	OR-LZ-8206/5/16/10	107
OR-AE-13276	157	OR-GM-9033/G	139	OR-LZ-8207/80	106
OR-AE-13277/W	113	OR-GM-9033/GR	139	OR-LZ-8207/125	106
OR-AE-13277/W/20	113	OR-GM-9033(GS)/B	139	OR-LZ-8207/160	106
OR-AE-13278/W	113	OR-GM-9033(GS)/C	139	OR-LZ-8207/250	106
OR-AE-13278/W/20	113	OR-GM-9033(GS)/G	139	OR-MP-6000/4/25	155
OR-AE-13279/W	113	OR-GM-9033(GS)/GR	139	OR-MP-6000/4/100	155
OR-AE-13279/W/20	113	OR-GM-9033(GS)/W	139	OR-MP-6000/5/25	155
OR-AE-13281/G	114	OR-GM-9033/W	139	OR-MP-6000/6/25	155
OR-AE-13281(GS)/G	114	OR-GM-9034/B	139	OR-MP-6000/6/100	155
OR-AE-13282/3M	112	OR-GM-9034/C	139	OR-MP-6000/7/25	155
OR-AE-13283/3M	112	OR-GM-9034/G	139	OR-MP-6000/7/100	155
OR-AE-13284/3M	112	OR-GM-9034/GR	139	OR-MP-6000/8/25	155
OR-AE-13285/3M	112	OR-GM-9034(GS)/B	139	OR-MP-6000/8/100	155
OR-AE-13286/B/1,9M	112	OR-GM-9034(GS)/C	139	OR-MP-6000/10/25	155
OR-AE-13286/W/1,9M	112	OR-GM-9034(GS)/G	139	OR-MP-6000/10/100	155
OR-AE-13287	157	OR-GM-9034(GS)/GR	139	OR-MP-6000/12/25	155
OR-AE-13288	127	OR-GM-9035/B	139	OR-MP-6000/12/100	155
OR-CR-268	23	OR-GM-9035/C	139	OR-MP-6001/7/5/25	155
OR-DB-KA-167/W	9	OR-GM-9035/G	139	OR-MP-6001/7/5/100	155
OR-DB-KA-168/W	9	OR-GM-9035/GR	139	OR-MP-6001/8/6/25	155
OR-DB-MP-166/B	10	OR-GM-9035(GS)/B	139	OR-MP-6001/8/6/100	155
OR-DB-MT-156	10	OR-GM-9035(GS)/C	139	OR-MP-6001/10/6/25	155
OR-DB-MT-156/W	10	OR-GM-9035(GS)/G	139	OR-MP-6001/10/6/100	155
OR-DC-633	22	OR-GM-9035(GS)/GR	139	OR-MP-6001/14/6/25	155
OR-DC-633-TEST	22	OR-GM-9035(GS)/W	139	OR-MP-6001/14/6/100	155
OR-DOM-BA-932/W	12	OR-GM-9035/W	139	OR-MT-BC-1811	21
OR-DOM-BA-933/W	12	OR-GM-9036/B	139	OR-MT-ME-1809	21
OR-DP-MR-149/B	6	OR-GM-9036/G	139	OR-OE-7100/B	119
OR-DP-MR-149/GR	6	OR-GM-9036(GS)/B	139	OR-OE-7100/B/10	119
OR-DP-MR-149/PW	6	OR-GM-9036(GS)/G	139	OR-OE-7100/GR	119
OR-DP-MR-149/W	6	OR-GM-9037/B	139	OR-OE-7100/GR/10	119
OR-DP-MR-150/B	7	OR-GM-9037/G	139	OR-OE-7100/W	119
OR-DP-MR-150/PW	7	OR-GM-9037(GS)/B	139	OR-OE-7100/W/10	119
OR-DP-MR-150/W	7	OR-GM-9037(GS)/G	139	OR-OE-7101/B	119
OR-GM-9027	142	OR-GM-9038	140	OR-OE-7101/B/10	119
OR-GM-9027(GS)	142	OR-GM-9038(GS)	140	OR-OE-7101/GR	119

OR-OE-7101/GR/10	119	OR-OE-7106/WT/10	121	OR-OE-7405(GS)/GR/10	125
OR-OE-7101/W	119	OR-OE-7200/B	116	OR-OE-7406/GR	125
OR-OE-7101/W/10	119	OR-OE-7200/B/10	116	OR-OE-7406/GR/5	125
OR-OE-7102/B	119	OR-OE-7200/W	116	OR-OE-7407/GR	125
OR-OE-7102/B/10	119	OR-OE-7200/W/10	116	OR-OE-7407/GR/5	125
OR-OE-7102/GR	119	OR-OE-7201/B	116	OR-OE-7408/GR	124
OR-OE-7102/GR/10	119	OR-OE-7201/B/10	116	OR-OE-7408/GR/10	124
OR-OE-7102/W	119	OR-OE-7201/W	116	OR-PI-456/24UC	104
OR-OE-7102/W/10	119	OR-OE-7201/W/10	116	OR-PI-456/230AC	104
OR-OE-7103/B	119	OR-OE-7204/B	117	OR-PI-457/1/230AC	104
OR-OE-7103/B/10	119	OR-OE-7204/B/10	117	OR-PI-457/1/UNI	104
OR-OE-7103/GR	119	OR-OE-7204/W	117	OR-PI-457/3/UNI	104
OR-OE-7103/GR/10	119	OR-OE-7204/W/10	117	OR-PRE-450	110
OR-OE-7103/W	119	OR-OE-7205/B	117	OR-PRE-451	110
OR-OE-7103/W/10	119	OR-OE-7205/B/10	117	OR-PRE-452/UNI	105
OR-OE-7104/B	121	OR-OE-7205(GS)/B	117	OR-PRE-453/UNI	105
OR-OE-7104/B/10	121	OR-OE-7205(GS)/B/10	117	OR-PRE-454/230	105
OR-OE-7104/GR	121	OR-OE-7205(GS)/W	117	OR-PRE-454/UNI	105
OR-OE-7104/GR/10	121	OR-OE-7205(GS)/W/10	117	OR-PRE-455	105
OR-OE-7104/W	121	OR-OE-7205/W	117	OR-PSU-1642	101
OR-OE-7104/W/10	121	OR-OE-7205/W/10	117	OR-PSU-1643	101
OR-OE-7105/B	121	OR-OE-7300/WB	122	OR-PSU-1644	101
OR-OE-7105/B/10	121	OR-OE-7300/WB/10	122	OR-PSU-1645	101
OR-OE-7105/GR	121	OR-OE-7301/WB	122	OR-PSU-1646	101
OR-OE-7105/GR/10	121	OR-OE-7301/WB/10	122	OR-PSU-1647	101
OR-OE-7105(GS)/B	121	OR-OE-7304/WB	122	OR-PSU-1648	101
OR-OE-7105(GS)/B/10	121	OR-OE-7304/WB	122	OR-PSU-1649	101
OR-OE-7105(GS)/GR	121	OR-OE-7305(GS)/WB	123	OR-PSU-1656	103
OR-OE-7105(GS)/GR/10	121	OR-OE-7305(GS)/WB/10	123	OR-PSU-1657	103
OR-OE-7105(GS)/W	121	OR-OE-7305/WB	123	OR-PSU-1658	103
OR-OE-7105(GS)/W/10	121	OR-OE-7305/WB/10	123	OR-PSU-1659	103
OR-OE-7105(GS)/WT	121	OR-OE-7306(GS)/WB	123	OR-PSU-1660	103
OR-OE-7105(GS)/WT/10	121	OR-OE-7306(GS)/WB/5	123	OR-PSU-1661	103
OR-OE-7105/W	121	OR-OE-7306/WB	123	OR-PSU-1662	103
OR-OE-7105/W/10	121	OR-OE-7306/WB/5	123	OR-PSU-1663	103
OR-OE-7105/WT	121	OR-OE-7307(GS)/WB	123	OR-PSU-1664	103
OR-OE-7105/WT/10	121	OR-OE-7307(GS)/WB/5	123	OR-PSU-1665	103
OR-OE-7106/B	121	OR-OE-7307/WB	123	OR-PSU-1666	101
OR-OE-7106/B/10	121	OR-OE-7307/WB/5	123	OR-PSU-1667	101
OR-OE-7106/GR	121	OR-OE-7400/GR	124	OR-SZ-8007	154
OR-OE-7106/GR/10	121	OR-OE-7400/GR/10	124	OR-SZ-8009	154
OR-OE-7106(GS)/B	121	OR-OE-7400/P/GR	124	OR-SZ-8017/2/10	153
OR-OE-7106(GS)/B/10	121	OR-OE-7400/P/GR/10	124	OR-SZ-8017/2/100	153
OR-OE-7106(GS)/GR	121	OR-OE-7401/GR	124	OR-SZ-8017/2/B10	153
OR-OE-7106(GS)/GR/10	121	OR-OE-7401/GR/10	124	OR-SZ-8017/3/10	153
OR-OE-7106(GS)/W	121	OR-OE-7404/GR	125	OR-SZ-8017/3/100	153
OR-OE-7106(GS)/W/10	121	OR-OE-7404/GR/10	125	OR-SZ-8017/3/B6	153
OR-OE-7106(GS)/WT	121	OR-OE-7404/P/GR	125	OR-SZ-8017/4/10	153
OR-OE-7106(GS)/WT/10	121	OR-OE-7404/P/GR/10	125	OR-SZ-8017/4/50	153
OR-OE-7106/W	121	OR-OE-7405/GR	125	OR-SZ-8017/4/B4	153
OR-OE-7106/W/10	121	OR-OE-7405/GR/10	125	OR-SZ-8017/5/8	153
OR-OE-7106/WT	121	OR-OE-7405(GS)/GR	125	OR-SZ-8017/5/50	153

OR-SZ-8017/5/B4	153	PS-4/W	135	ZA-15	167
OR-SZ-8018/4	151	SW/MV-5	34	ZA-16	167
OR-SZ-8018/4/10	151	SW/R-3	34	ZA-17	167
OR-SZ-8018/6	151	SW/R-4	34	ZA-18	167
OR-SZ-8018/6/10	151	TA-1	161	ZA-19	167
OR-SZ-8018/10	151	TA-5	161		
OR-SZ-8018/10/10	151	TA-6	161		
OR-SZ-8018/16	151	TA-7	161		
OR-SZ-8018/16/10	151	TA-8	161		
OR-SZ-8018/25	151	TC-2/B/AD	71		
OR-SZ-8018/25/10	151	TC-2/B/I	71		
OR-SZ-8019/4	151	TC-2/B/L	71		
OR-SZ-8019/4/10	151	TC-2/W/AD	71		
OR-SZ-8019/6	151	TC-2/W/I	71		
OR-SZ-8019/6/10	151	TC-2/W/L	71		
OR-SZ-8019/10	151	TC-3/B	71		
OR-SZ-8019/10/10	151	TC-3/W	71		
OR-SZ-8019/16	151	TC-4/B	71		
OR-SZ-8019/16/10	151	TC-4/W	71		
OR-SZ-8019/25	151	TL-2/B	70		
OR-SZ-8019/25/10	151	TL-2/W	70		
OR-SZ-8020	154	TL-3/B	70		
OR-SZ-8021/1/10	153	TL-3/W	70		
OR-SZ-8021/1/100	153	TR-2/B/1M	71		
OR-SZ-8021/1/B10	153	TR-2/W/1M	71		
OR-SZ-8021/2/10	153	TR-3/B/2M	71		
OR-SZ-8021/2/50	153	TR-3/W/2M	71		
OR-SZ-8021/2/B6	153	VDP-60FHD	16		
OR-SZ-8021/3/9	153	VDP-67	15		
OR-SZ-8021/3/50	153	VDP-68/W	16		
OR-SZ-8021/3/B4	153	VDP-69	15		
OR-VID-MO-1076/W/F	13	VI-VID-RO-1077	14		
OR-VID-MO-1076/W/S	13	WB-1	23		
OR-VID-MS-1078	14	WL-11	78		
OR-WAT-419	108	WL-12	78		
OR-WAT-419/B	108	WL-13	78		
OR-WAT-435	108	ZA-1/10	167		
OR-WAT-435/B	108	ZA-1/S/10	167		
OR-WE-523	99	ZA-2/2	167		
OR-WE-524	99	ZA-3/S/2	167		
OR-WE-525	99	ZA-4	167		
OR-WE-526	99	ZA-5	167		
OR-ZS-827	18	ZA-6	167		
OR-ZS-850	17	ZA-7	167		
OR-ZS-850/B	17	ZA-8	167		
OR-ZS-854	19	ZA-9	167		
OR-ZS-855	19	ZA-10	167		
PS-1/B/1,5M	134	ZA-11	167		
PS-1(GS)/B/1,5M	134	ZA-12/W/1,8M	167		
PS-2/B/1,5M	134	ZA-12/W/5M	167		
PS-3/B/1,5M	135	ZA-13	167		
PS-4(GS)/W	135	ZA-14	167		



ORNO GROUP Sp. z o.o.
ul. Rolników 437
44-141 Gliwice, POLAND

+48 32 43 43 110
www.orno.pl

KAT.2023-01



5 904988 909506