



Operating and installation instructions

Video doorphone set Xiran

OR-VID-MA-1079/B



CE STOP!

Be sure to read the **instruction manual** before installation!
Damage resulting from incorrect connection
ARE NOT SUBJECT TO REPAIR UNDER WARRANTY!



TABLE OF CONTENTS

1. SAFETY INSTRUCTIONS	3
2. CHARACTERISTICS OF THE SET	4
3. TECHNICAL DATA	4
4. SET CONSTRUCTION	5
5. INSTALLATION	6
MONITOR INSTALLATION.....	6
OUTDOOR UNIT WITH CAMERA INSTALLATION.....	6
6. WIRING DIAGRAMS	7
7. SET OPERATION	9
MAIN MENU	9
OUTDOOR UNIT MONITORING	10
IP CAMERA MONITORING	11
RECORDINGS AND STORAGE	11
CONNECTION AND CONVERSATION.....	12
EVENT.....	12
8. SETTINGS	13
SETTING MENU	13
SYSTEM SETTINGS	14
ADMINISTRATOR SETTINGS.....	15
PROXIMITY CARDS AND TAGS MANAGEMENT	15
OUTDOOR UNIT SETTINGS.....	16
IP CAMERA SETTINGS.....	17
NETWORK SETTINGS	17
DIGITAL FRAME SETTINGS	18
ADVANCED SETTINGS	19
SYSTEM INFORMATION	19
9. IP CAMERA CONNECTION	20
WIRED CONNECTION	20
WIRELESS CONNECTION	21
10. MOBILE APP INSTALATION	22
LOGIN	22
PAIRING THE DEVICE WITH THE PHONE	22
INVITING USERS.....	24
11. CLEANING AND MAINTENANCE	24
12. TROUBLESHOOTING	25



1. SAFETY INSTRUCTIONS

Before using the device, read this Service Manual and keep it for future use. The manufacturer is not responsible for any damage that can result from improper device installation or operation. Any repair or modification carried out by yourselves results in loss of guarantee. Installation and commissioning of the equipment by the customer are possible if the installer has basic knowledge of electrical systems and the use of proper tools. In view of the fact that the technical data are subject to continuous modifications, the manufacturer reserves a right to make changes to the product characteristics and to introduce different constructional solutions without deterioration of the product parameters or functional quality. Additional information about ORNO products is available at www.orno.pl. Orno-Logistic Sp. z o.o. holds no responsibility for the results of non-compliance with the provisions of the present Manual Orno-Logistic Sp. z o.o. reserves the right to make changes to the Manual – the latest version of the Manual can be downloaded from www.orno.pl Any translation/interpretation rights and copyright in relation to this Manual are reserved.

1. Disconnect the power supply before performing any activities.
2. Do not immerse the product in water or other liquids.
3. Do not operate the device with damaged housing.
4. Do not break the seals or open the device and do not repair it yourself.
5. Do not use the device contrary to its dedication.
6. Do not install the monitor near devices that strongly emit magnetic fields such as TV, speakers.
7. Do not install the monitor in a place exposed to high moisture, vibration, shock and strong sunlight.
8. Turn off the power if there is a concerning sound coming from the device.
9. Remove the protective film from the monitor screen after installation and mounting.



Each household is a user of electrical and electronic equipment, and hence a potential producer of hazardous waste for humans and the environment, due to the presence of hazardous substances, mixtures and components in the equipment. On the other hand, used equipment is valuable material from which we can recover raw materials such as copper, tin, glass, iron and others. The WEEE sign placed on the equipment, packaging or documents attached to it indicates the need for selective collection of waste electrical and electronic equipment. Products so marked, under penalty of fine, cannot be thrown into ordinary garbage along with other waste. The marking means at the same time that the equipment was placed on the market after August 13, 2005. It is the responsibility of the user to hand the used equipment to a designated collection point for proper processing. Used equipment can also be handed over to the seller, if one buys a new product in an amount not greater than the new purchased equipment of the same type. Information on the available collection system of waste electrical equipment can be found in the information desk of the store and in the municipal office or district office. Proper handling of used equipment prevents negative consequences for the environment and human health!

06/2024



2. CHARACTERISTICS OF THE SET

The videodoorphone is designed for installation in 1-family buildings.

Functions:

- simultaneous view and hold of a conversation with a person in front of an entrance;
- direct control of an electric door strike;
- gate control;
- built-in RFID reader allows access with proximity cards and tags;
- remote control using a phone app;
- adjustment of monitor parameters (image brightness, volume);
- infrared LED lighting enables night vision;
- digital frame, weather forecast and answering machine functions;
- intercom function when additional monitors are used.

Key features:

- large 8" LCD color monitor with touchscreen;
- SD card reader (with a maximum capacity of 128GB);
- 5 ringtones to choose from and the option to set your own sound stored on the microSD card;
- outdoor unit with Full HD wide-angle camera;
- possibility to control the device from your smartphone (free app);
- the possibility to record photos, sounds and videos on a microSD card and play them back on the monitor or in the Tuya app;
- 2-wire installation;
- set can be expanded to include two outdoor units, two IP cameras and six monitors;
- control of an electric door strike (12V DC max. 300mA) without an additional power supply.

3. TECHNICAL DATA

TYPE OF THE DEVICE:	single family
INSTALLATION METHOD:	2-wire
COMMUNICATION SYSTEM:	wireless - monitor and WiFi router, wired - monitor and outdoor unit
WLAN FREQUENCY RANGE:	2.400-2.483,5 MHz (802.11b/g/n)
MAXIMUM TRANSMITTING POWER:	<100mW EIRP

MONITOR

SCREEN SIZE:	8"
RESOLUTION:	1024x600x3RGB
STANDARD:	PAL
FUNCTIONS:	call, monitoring, door and gate control, monitor and volume control, mute mode, intercom digital frame, answering machine, weather forecast
NUMBER OF MELODIES:	5
VOLUME CONTROL:	yes
CALL TIME:	120s
MONITORING TIME:	30s
POWER SUPPLY:	24V DC 1A
POWER CONSUMPTION:	standby <3.5W; work <6W
ELECTRICAL STRIKE CONTROL:	yes (12V DC max. 300mA - powered from monitor)
GATE CONTROL:	yes, dry contact
WORKING TEMPERATURE:	-20°C ~ +50°C
INSTALLATION:	surface-mounted
MATERIAL:	plastic
DIMENSIONS:	215 x 153 x 21mm
NET WEIGHT:	0.455kg



OUTDOOR UNIT

SENSOR TYPE:	CMOS 1/2.9'
RESOLUTION:	2MP, 1920x1080, 1080p
VIEWING ANGLE (VERTICAL/HORIZONTAL):	54° / 108°
NIGHT LIGHTING:	IR
NUMBER OF DIODES:	4
NIGHT VISION RANGE:	approx. 1m
RFID READER:	119-128.6 kHz RFID-tags/cards (max. 200 users)
MAXIMUM TRANSMITTING POWER:	<10mW ERP
MOTION SENSOR:	yes
INGRESS PROTECTION:	IP65
POWER SUPPLY:	24V DC from monitor
POWER CONSUMPTION:	standby <1.5W, work <3W
WORKING TEMPERATURE:	-20°C ~ +50°C
INSTALLATION:	surface-mounted
MATERIAL:	aluminum
DIMENSIONS:	67 x 159 x 31mm
NET WEIGHT:	0.245kg

4. SET CONSTRUCTION



fig. 1 Construction of the monitor

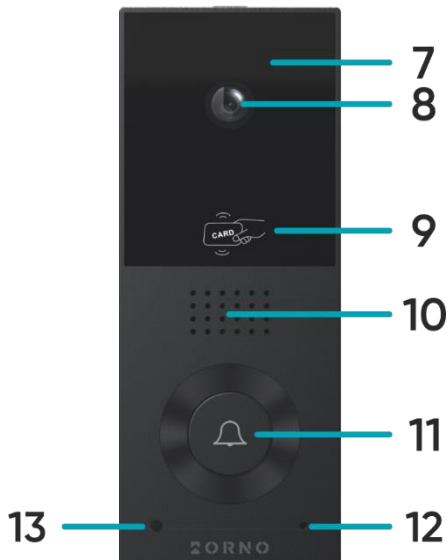

fig. 2 Construction of the outdoor unit with camera

MONITOR

- | | |
|----------------------|-------------------------------|
| 1. LCD touchscreen | 4. Holes for mounting bracket |
| 2. Microphone | 5. Connection terminals |
| 3. MicroSD card slot | 6. Loudspeaker |

OUTDOOR UNIT

- | | |
|---------------------------|--|
| 7. Night-time lighting | 11. Call button/ status indicator
(blue: normal work, red: opening) |
| 8. Camera lens | 12. Microphone |
| 9. RFID-tags/cards reader | 13. Twilight sensor |
| 10. Loudspeaker | |



5. INSTALLATION

MONITOR INSTALLATION

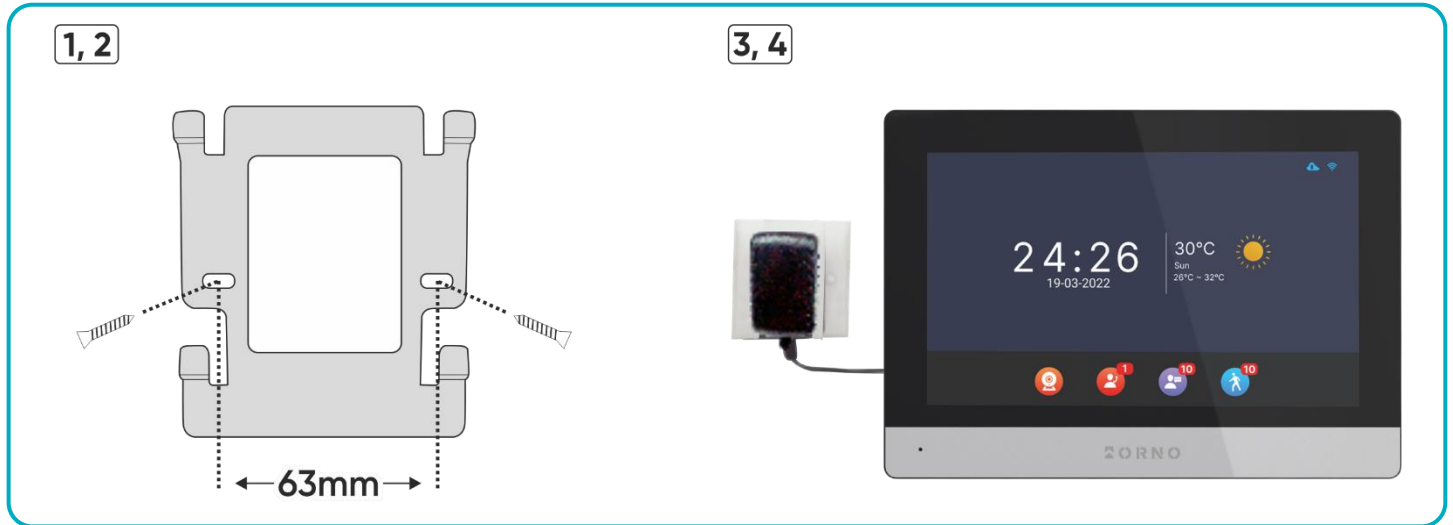

fig. 3 Monitor installation

1. Drill holes in the wall and insert wall anchors into them.
2. Screw the monitor mounting bracket to the wall with screws.
3. Connect the wires to the monitor and hang it on the mounting bracket.
4. Connect the power supply to the 230V AC outlet.

OUTDOOR UNIT WITH CAMERA INSTALLATION

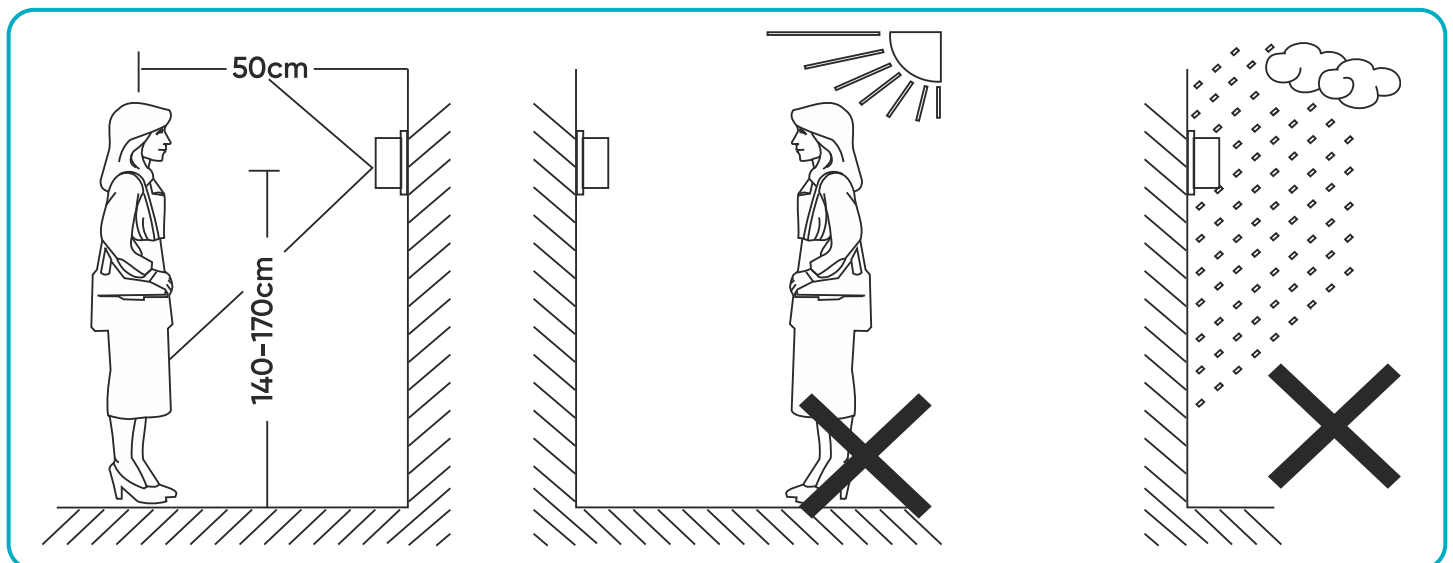

fig.4 Outdoor unit placement

Recommended installation height of the outdoor unit is 140-170cm.

The correct location of the outdoor unit determines the comfort of working with the device. It is recommended to test the device before making mounting holes. Do not place the outdoor unit and monitor in the same room as feedback may occur.

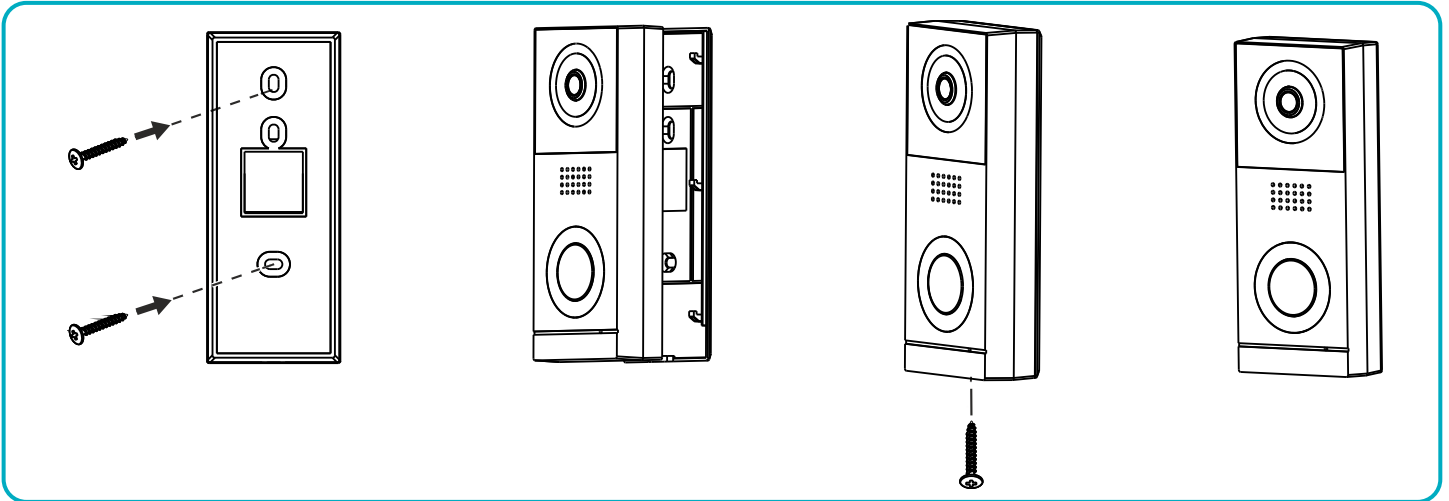

fig. 5 Outdoor unit with camera installation

1. Drill holes in the wall and insert the wall anchors into them.
2. Attach the mounting frame of the outdoor unit in desired place using screws.
3. Connect the wires according to the wiring diagram.
4. Place the outdoor unit in the mounting frame and secure it by screwing in the security screw from below.

6. WIRING DIAGRAMS

Before drilling the installation holes, it is recommended to carry out a functional test of the device. To do this, connect the device for a test according to the wiring diagram. The first person holding the camera should use the button to call the second person who is at the monitor. This person should then carefully inspect the camera's field of view in order to correct the module's position if necessary.

Once the measurements have been taken accurately, proceed with the mounting holes after switching off the power supply.

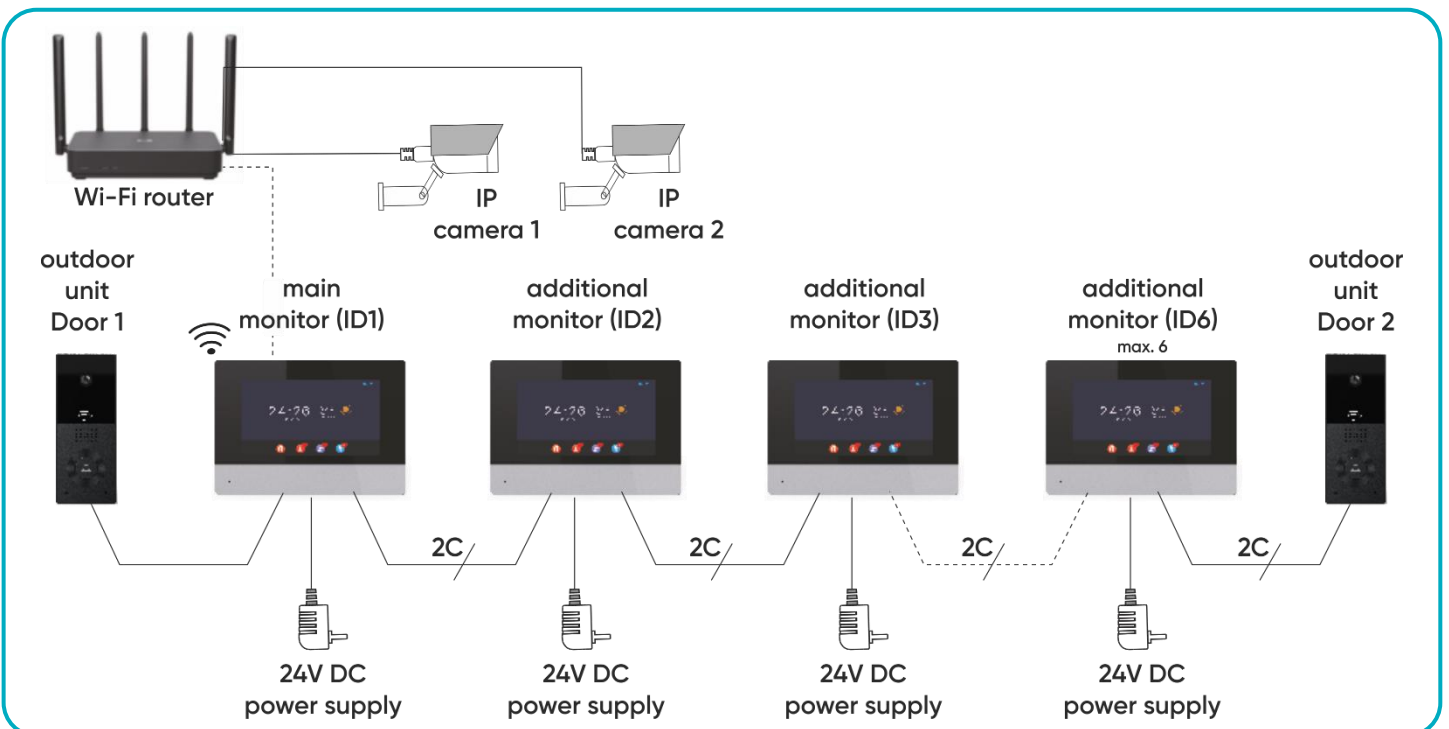

fig. 6 Wiring diagram

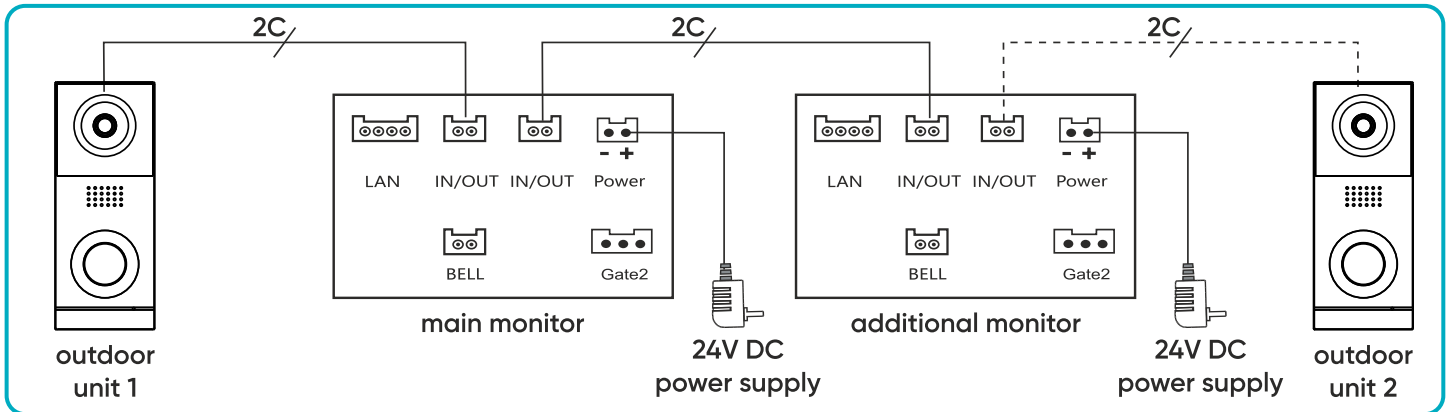

fig. 7 Monitor and outdoor unit wiring diagram.

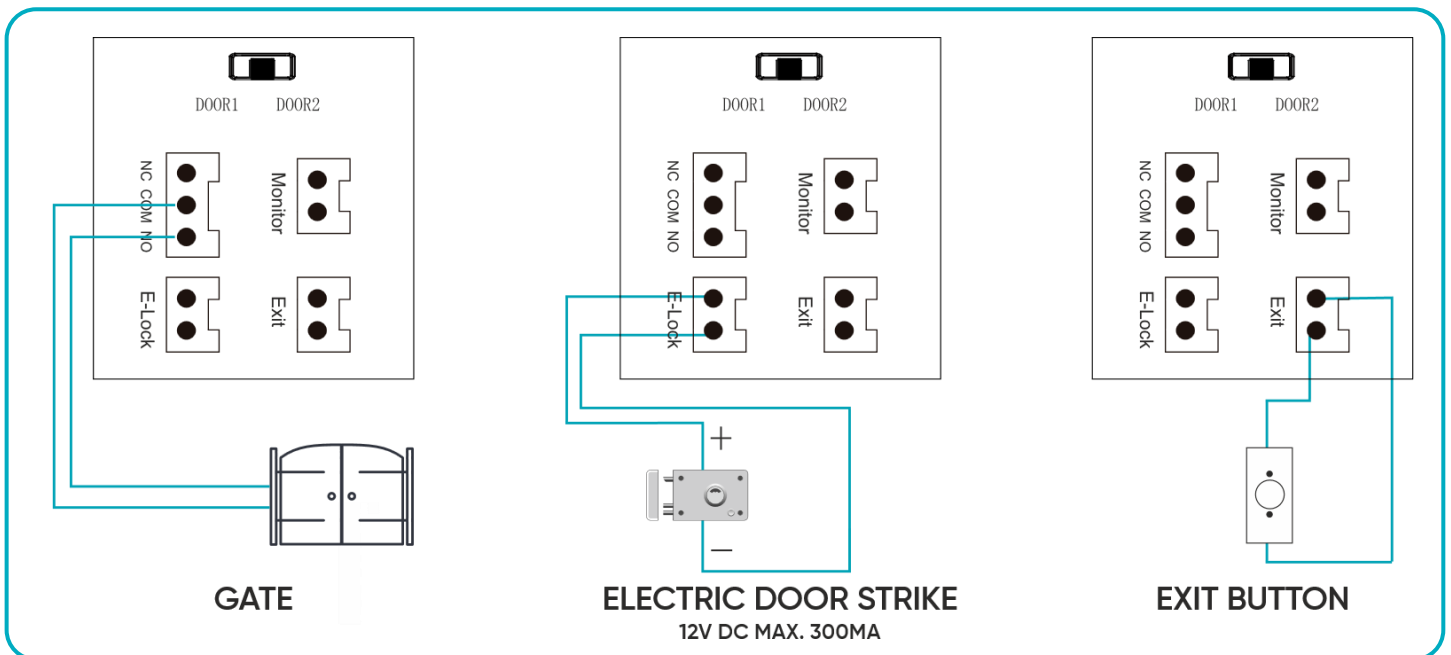

fig. 8 Gate, electric door strike, and exit button wiring scheme.

It is forbidden to make connections to live equipment!
Failure to adhere to this recommendation may result in permanent damage to the device and loss of health.

The set does not include an electric door strike and automatic gate control unit!

The video doorphone cables should not be routed in one cable with the cables of other installations such as bell, alarm, etc. Any power and telecommunication cables emitting strong magnetic fields (e.g. loudspeaker columns, TV set) in direct contact with the cables connecting the outdoor unit to the monitor may adversely affect the operation of the set.

If the user has other connection cables than the recommended ones, it is allowed to use them, however, it is necessary to make a test connection of the set in order to check its correct functioning.

When designing the electrical installation, take into account the appropriate cable cross-section:

up to 30m - recommended cable XzTKMXpw 3 x 2 x 0,5mm

from 30m to 100m - recommended cable XzTKMXpw 3 x 2 x 0,8mm

The connection to the electromagnetic lock should be made with 2 x 1mm² cable.

The set is compatible with any electric door strike with 12V DC supply voltage and current consumption of max. 300 mA.

The total length of the installation must not exceed 100 meters.

We absolutely do not recommend the use of twisted-pair cables.



7. SET OPERATION

MAIN MENU



1 Intercom Intercom function available with additional monitors connected – tap to select the monitor you want to connect to.

Monitor selection screen:

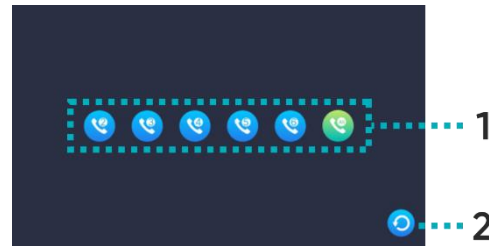

Call screen:

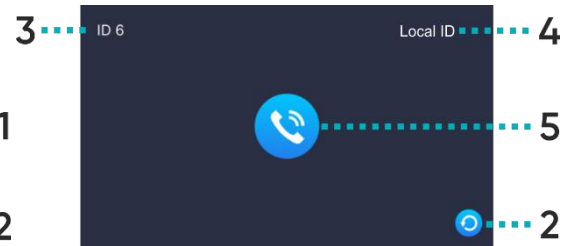

1 Select the monitor you want to connect to,
 2 Return to the previous page,
 3 ID of the monitor you are connecting to,
 4 ID of the monitor you are using,
 5 Call button - tap to connect to the selected monitor.

2 Monitoring Tap to open the outdoor unit/IP camera view.

3 Event Tap to check the record of calls, detected motion and stored photos.

4 Media Tap to enter a folder with media files, including music, photos (requires a microSD card).

5 Settings Tap to enter the settings menu.

6 Operating mode Three possible settings: at home/ not at home/ sleep.
At home: call and conversation available,
Not at home: option of leaving a message by a visitor, sends a push notification on the phone when activity is detected,
Sleep: monitor muted, sends a push notification on the phone when activity is detected.

7 Gate2 Tap to open the gate (if the gate is connected).

8 Standby Tap to enter standby mode.

9 Back Tap to return to the previous page.



OUTDOOR UNIT MONITORING

After tapping the *Monitoring* icon in the main menu or while connected to an outdoor unit, the outdoor camera view screen will be displayed. The maximum monitoring and call time is 30 seconds and the maximum call and conversation time is 120 seconds.

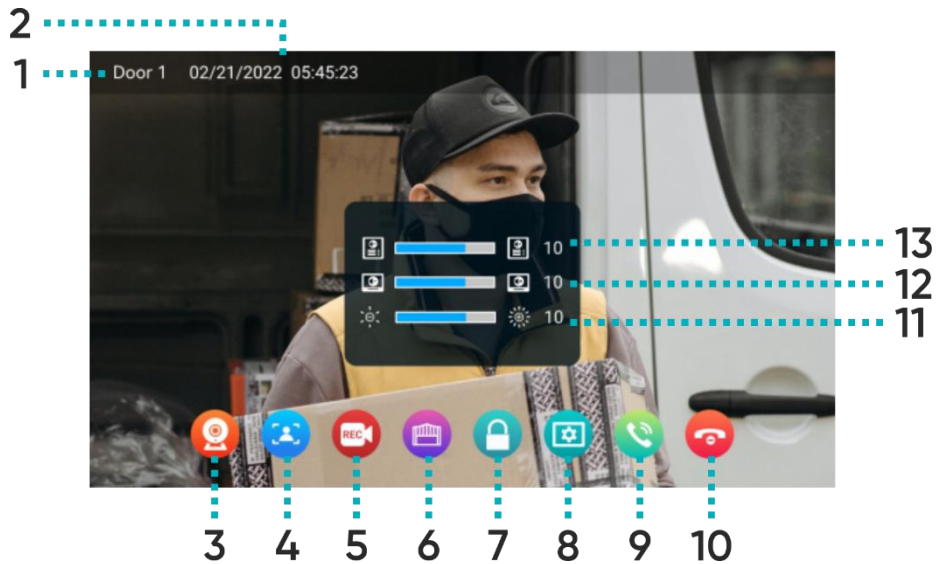

1	Source	Indicates from which camera the view is displayed.
2	Date and time	Displays the current date and time.
3	Switch between cameras	Tap to change the camera view Door1/Camera1/Door2/Camera2.
4	Photo	Tap to save the image of the outdoor camera view (requires a microSD card).
5	Video	Tap to save the recording from the outdoor camera (requires a microSD card).
6	Gate opening	Tap to open the gate.
7	Door/wicket opening	Tap to release the electric door strike and open the door/wicket.
8	Settings	Tap to enter the settings menu: 11 Adjust the brightness of the image, 12 Adjust the volume of the monitor, 13 Adjust the volume of the outdoor unit.
9	Answer the call	Tap to start a conversation (maximum conversation time is 120 seconds).
10	End the call	Tap to end the call and return to the main menu.



IP CAMERA MONITORING

After switching to IP camera view, the image from the selected camera will be displayed. The maximum monitoring time is 30 seconds. During the monitoring, you can save a video recording (requires a microSD card). **Note:** this function is only available when an IP camera is connected.

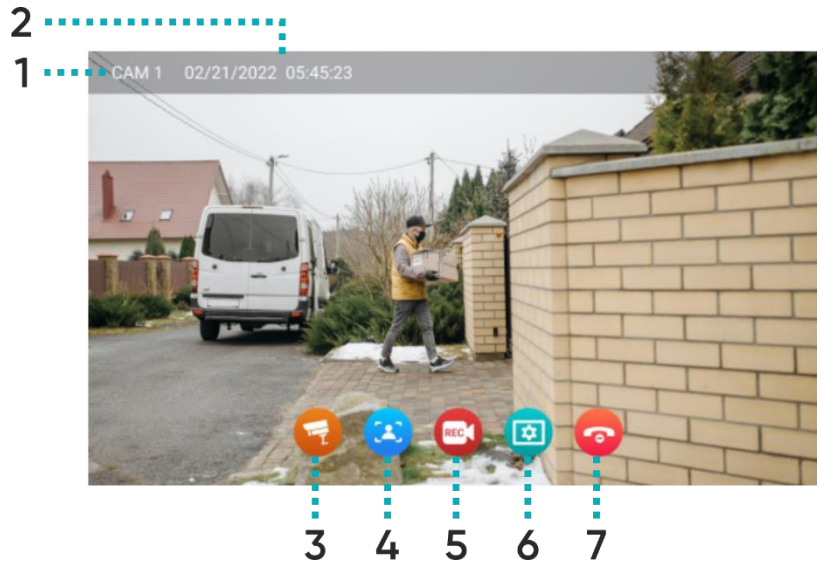

1	Source	Indicates from which camera the view is displayed.
2	Date and time	Displays the current date and time.
3	Switch between cameras	Tap to change the camera view Door1/Camera1/Door2/Camera2.
4	Photo	Tap to save the image of the outdoor camera view (requires a microSD card).
5	Video	Tap to save the recording from the outdoor camera (requires a microSD card).
6	Settings	Tap to enter the settings menu: 11 Adjust the brightness of the image.
7	End monitoring	Tap to end monitoring and return to the main menu.

RECORDINGS AND STORAGE

Important: Videos and photos cannot be saved and stored unless an SD memory card is installed in the device. To add a memory card, turn off the monitor, place the microSD memory card in the slot on the side of the monitor (maximum card capacity 128GB), and then turn on the monitor. It is also recommended to format the new SD card in the monitor settings (see page 18 *Advanced settings*).

1. All saved files can be viewed on a computer ([xxx.record] folder on the memory card).

3. Each file can be checked for date, recording time, source (from which camera the video/photo was recorded) and its format can be checked.

File name: YYYYMMDD-HHMMSS-ABC.AVI or JPG (year/month/day-hour/minute/second-)

Note: Meaning of the last three digits (marked ABC):

A: 1 – Door1 / 2 – Door2 / 3 – Camera1 / 4 – Camera2

B: 1 – MANUAL (manual recording) / 2 – AUTO / 3 – MOTION SENSOR / 4 – ALARM

C: 0 – photo / 1 – video recording

Example:

File name: „20180109_045740_121.avi“

Video recorded automatically, triggered by visitors using the Call button on Door 1, on 9 January 2018, at 4:57:40.



CONNECTION AND CONVERSATION

1. When the *call* button on the outdoor unit is pressed, the monitor beeps and the image from the external camera is displayed on the screen. The ringing time is max. 30 seconds.
2. When the *answer call* button is tapped, the conversation can be started. The conversation time is max. 120 seconds. During the call, the door/gate can be opened.
3. When another call comes in from the second outdoor unit, a new call will be started only when the current call ends.
4. When the *end call* button is tapped, the conversation ends. The monitor returns to the main screen.

EVENT

After tapping the *Event* icon in the main menu, a menu with three catalogues of registers will be displayed. Proper operation of the registers is possible only after adding a microSD memory card to the monitor.

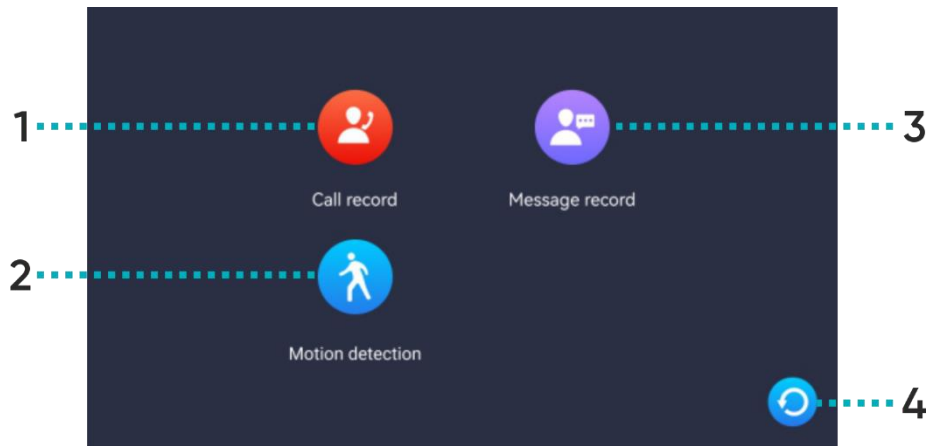

1	Call record	A record of pictures/video recordings saved when the call button is pressed on the outdoor unit.
2	Motion detection	A record of pictures/video recordings saved when motion is detected by an outdoor unit.
3	Message record	A record of pictures/video recordings saved when the call button on the outdoor panel is pressed. Note: recording function available only in the <i>not at home</i> mode.
4	Back	Tap to return to the previous page.

Tapping on the icon of the chosen catalogue opens the register of saved files. From this menu level, you can freely manage the files stored on the SD card.

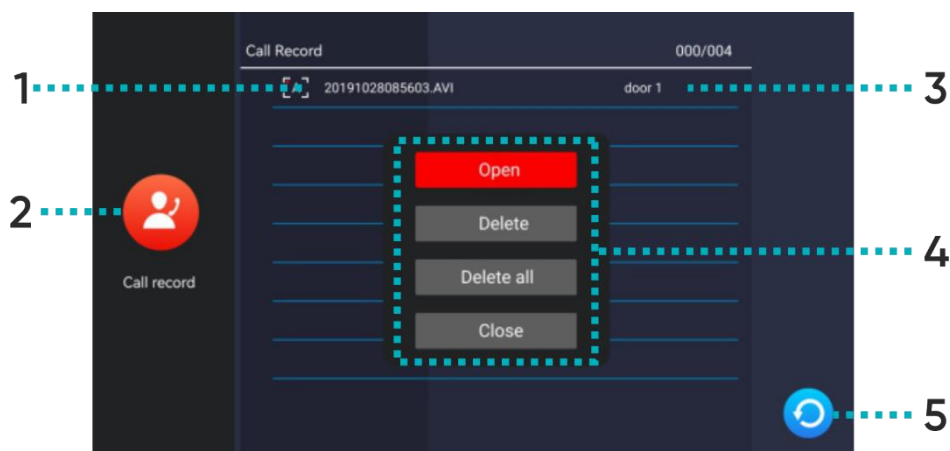



1	File name	The name contains the date and time the file was saved (year/month/day-hour/minute/second-source/mode/format, see page 10 <i>RECORDINGS AND MEMORY</i>).
2	Register icon	Displays the icon of the selected catalogue.
3	Source	Displays the source from which the image/video recording was saved.

Tap the chosen file name to open the actions menu:
Open – opens the selected file:

4 Actions

1 Play/Pause button (applies to video recordings only),
 2 Source – displays the date, time and source of the recorded image/video,
 3 Playback bar – displays the remaining time (applies to video recordings only),
 4 Back – tap to return to the previous page.

Delete – deletes the selected file,
Delete all – deletes all files in the open catalogue,
Close – closes the action menu.

5	Back	Tap to return to the previous page.
---	------	-------------------------------------

8. SETTINGS

SETTING MENU

After tapping the Settings icon in the main menu, the settings menu will be displayed. Tap another icon to move to the next setting category. After 30 seconds of inactivity, the screen will return to the main menu.

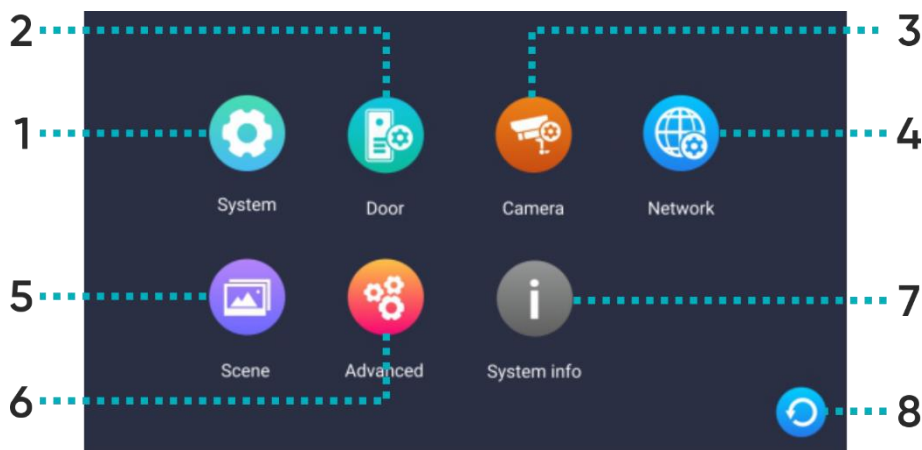

1	System	Tap to enter the system settings.
2	Door	Tap to enter the outdoor unit settings.
3	Camera	Tap to enter the IP camera settings.



- | | | |
|----------|-------------|--|
| 4 | Network | Tap to enter the network settings and configure the device with Wi-Fi. |
| 5 | Scene | Tap to enter the digital frame settings. |
| 6 | Advanced | Tap to enter the advanced settings. |
| 7 | System info | Tap to open the system information tab. |
| 8 | Back | Tap to return to the previous page. |

SYSTEM SETTINGS

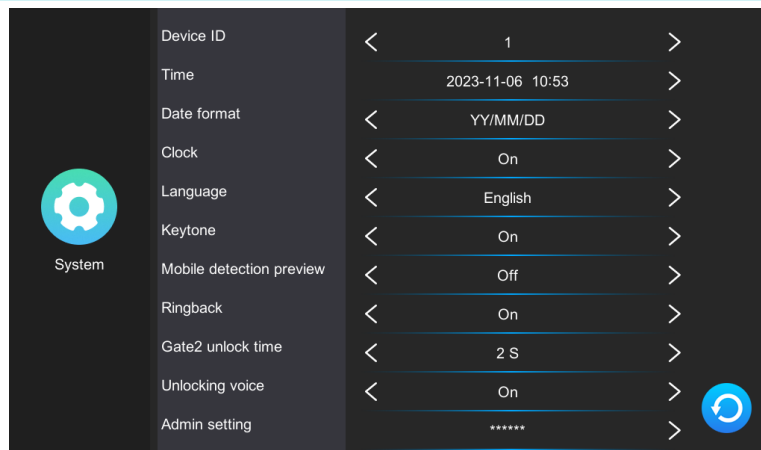

Device ID

Displays the ID number of the current monitor. Number 1 is the default number of the main monitor, numbers 2-6 are the default numbers of additional monitors.

Time

Date and time configuration (the system automatically updates the date and time information when connected to the phone).

Date format

Date format settings.

Clock

Enable or disable the clock function during standby mode.

Language

Language selection. Available languages: English, Polish, German, French, Portuguese, Spanish, Chinese, Italian, Hebrew, Japanese.

Keytone

Enable or disable touch sound.

Mobile detection preview

Enable or disable the external camera view function during detected motion.

Ringback

Enable or disable the doorbell sound on the outdoor unit.

Gate unlock time

Opening time settings for Gate 2 (which is directly connected with the monitor).

Unlocking voice

Enable or disable the voice response from the outdoor panel when the door or gate is opened (available in English only).

Admin setting

Enter the administrator settings by entering the administrator password (default: 888888).



ADMINISTRATOR SETTINGS

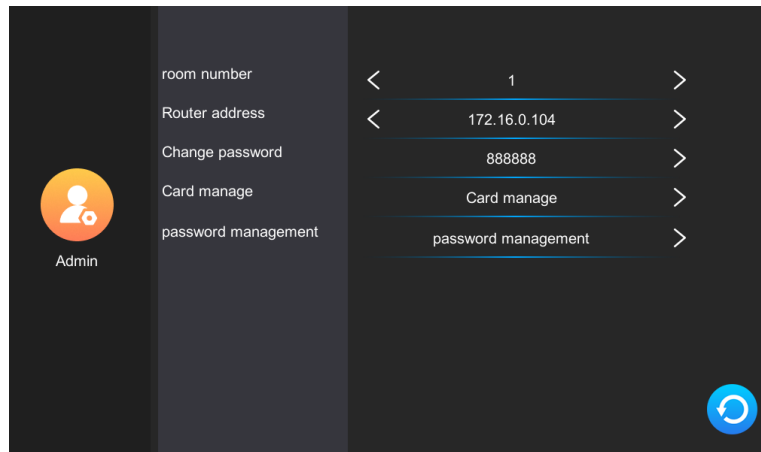

Room number	Setup the room number of the selected monitor (applies to multifamily models).
Router address	Displays the IP address of the device.
Change password	Tap to change the administrator password.
Card manage	Tap to open the configuration menu for proximity cards and tags.
Password management	Tap to open the configuration menu for access passwords that allow to open the door from the level of the outdoor unit (does not apply to OR-VID-MA-1079 model).

PROXIMITY CARDS AND TAGS MANAGEMENT

After tapping on the *Card manage* option in the administrator settings menu, the proximity card and tag settings menu will be displayed.

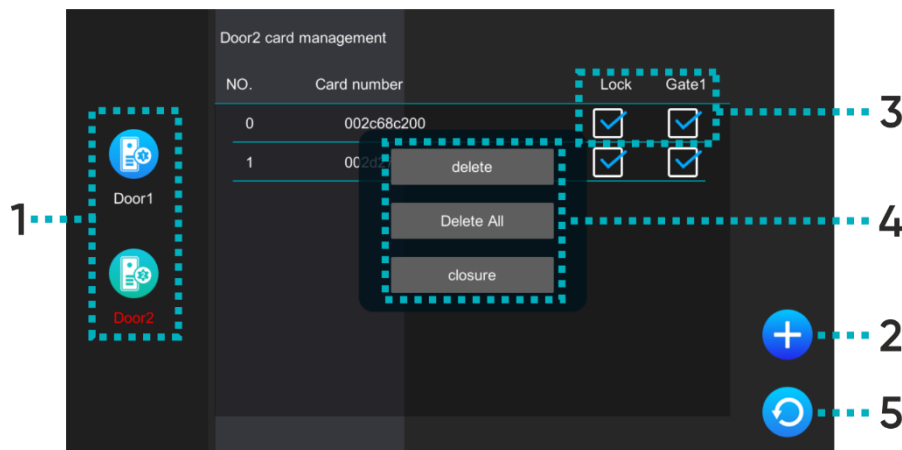

1	Door	Select Door1/Door2 to edit the accesses of the selected outdoor unit.
2	Add	Tap to add a new proximity card or tag and then place the card/tag close to the RFID reader on the outdoor unit. You can add multiple proximity cards/tags at once by bringing them close to the reader one by one. Each correct addition will be indicated by a short beep. Tap <i>back</i> to return to the cards and tags settings menu - all added cards/tags will be displayed on the list.



- | | | |
|----------|---------|--|
| 3 | Access | Select what can be opened by the selected proximity card/tag (lock - releases the electric strike, gate1 - controls the opening/closing of the gate). |
| 4 | Actions | Tap the chosen card number to open the actions menu:
Delete – removes the selected proximity card/tag,
Delete all – removes all proximity cards/tags,
Close – closes the actions menu. |
| 5 | Back | Tap to return to the previous page. |

OUTDOOR UNIT SETTINGS

After tapping the *Door* icon in the settings menu, the outdoor unit settings menu will be displayed.

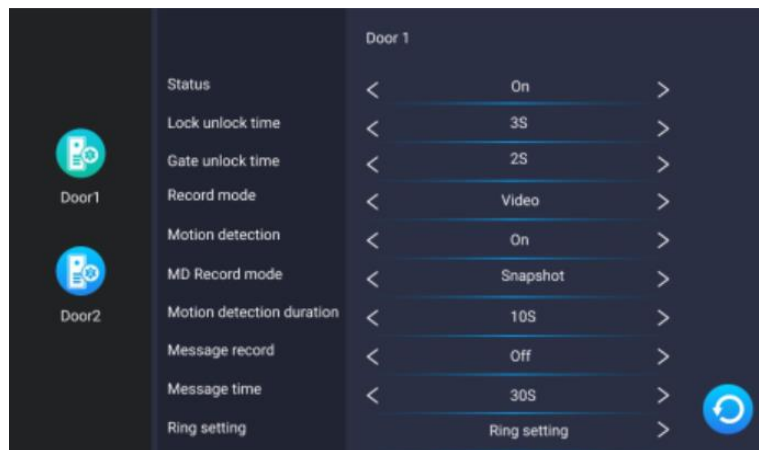

- | | |
|----------------------------------|--|
| Status | Turn the outdoor unit on or off from the level of the monitor. |
| Lock unlock time | Door/wicket opening settings (1-10s). |
| Gate unlock time | Gate opening settings (1-10s). |
| Record mode | Incoming call recording format settings (photo/video recording). |
| Motion detection | Enable or disable motion detection function (works only with digital frame off). |
| MD record mode | Motion detection file saving format settings (photo/video recording). |
| Motion detection duration | Motion detection time settings. |
| Message record | Enable or disable the visitor's message function. |
| Message time | Settings for the maximum length of a message left by a visitor. |
| Ring setting | Melody and volume of the ringtone settings. |



IP CAMERA SETTINGS

After tapping the *Camera* icon in the settings menu, the IP camera settings menu will be displayed. To configure an IP camera, go to section 9. *IP CAMERA CONNECTION*.

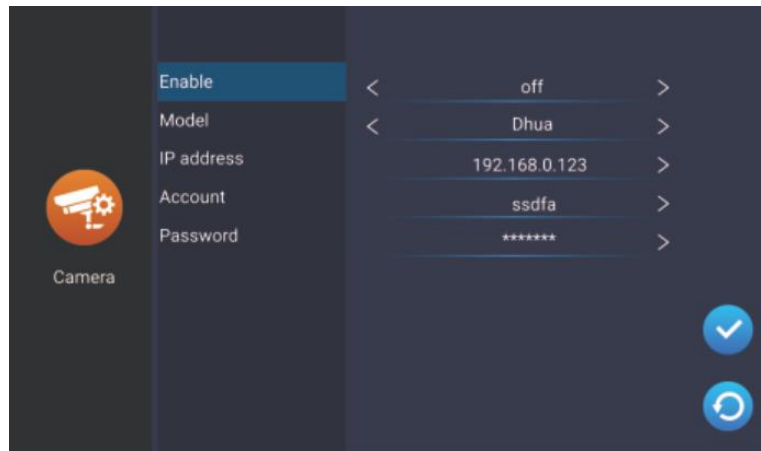

Enable Turn the IP camera on or off from the level of the monitor.

Model Select the model of your IP camera to complete the configuration.

IP address Enter the IP camera's IP number to complete the configuration.

Account Enter the account number (login) of your IP camera.

Password Enter the IP camera's password.

NETWORK SETTINGS

After tapping the *Network* icon in the settings menu, the network settings menu will be displayed. From this level you can connect your device to a Wi-Fi network.

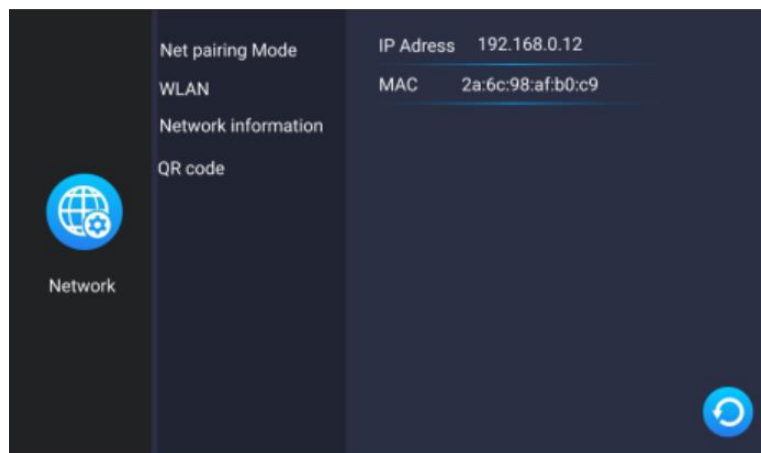

Net pairing mode Select the device's Wi-Fi connection mode:
EZ mode – wireless Wi-Fi connection,
Cable* – wired connection using Cat.5a cable.

WLAN Connect to a Wi-Fi network. The device automatically searches for the nearest Wi-Fi networks – select your network and enter the password to connect the device to the Internet. If the device does not detect a Wi-Fi network, you can add one manually by entering the network's IP and password.



Network information Display the information of the network to which the device is connected.

QR code Display the QR code to download the Tuya Smart mobile app.

* To use the Tuya Smart app with a wired connection:

1. Connect the monitor to your Wi-Fi router with a Cat.5a cable.
2. Then in the network settings, change the connection mode from *EZ mode* to *Cable*.
3. Change the network connection category from *statically assigned* to *dynamically assigned*.
4. After changing the category, press *back* and the monitor will display a system reboot window.
5. Allow the system to reboot and wait for the monitor to restart.
6. After restarting the system, enter the network settings again and open the QR Code tab to display the QR code that allows to connect the set with the mobile app.

DIGITAL FRAME SETTINGS

After tapping the *Scene* icon in the settings menu, the digital frame settings menu will be displayed. In order to use all digital frame features, photos must be placed on the SD card in the *picture* folder, while music must be placed in the *music* folder.

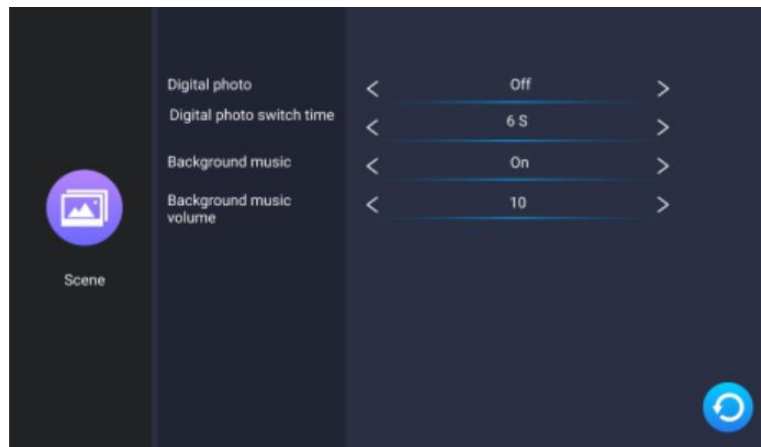

Digital photo Enable or disable digital frame function (function active only in standby mode and with motion detection disabled).

Digital photo switch time Photo display time settings.

Background music Enable or disable the background music function when the digital frame is displayed.

Background music volume Background music volume settings.



ADVANCED SETTINGS

After tapping the *Advanced* icon in the settings menu, the advanced settings menu will be displayed.

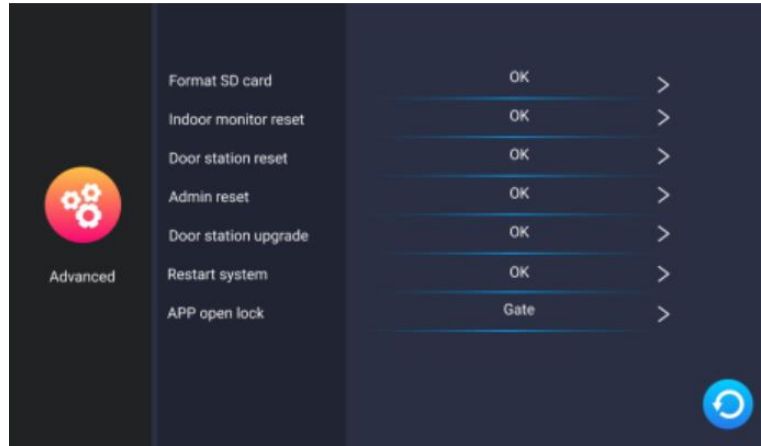

Format SD card	Tap to format the SD card. After adding a new SD card to the device, it is recommended to format it before further use.
Indoor monitor reset	Tap to restore the factory settings of the monitor. Be sure to remove the device from the Tuya app as well before doing this, otherwise the device cannot be added and used by other accounts. Note: if you return or refer the device for service repair, you must remove the device from the Tuya Smart app and restore it to factory settings!
Door station reset	Tap to restore the factory settings of the outdoor unit.
Admin reset	Tap to restore the default administrator password.
Door station upgrade	Tap to update the outdoor unit software (make sure the software has been copied to the SD card before updating).
Restart system	Tap to reboot the system.
App open lock	Tap to configure accesses from the mobile app (select Gate1 - unlock from the outdoor panel and Gate2 - unlock from the monitor).

SYSTEM INFORMATION

After tapping the *System info* icon in the settings menu, the system information tab will be displayed. Here you will find information about the system and software version, update date, used and total memory of the microSD card as well as the login ID for the Tuya Smart app.

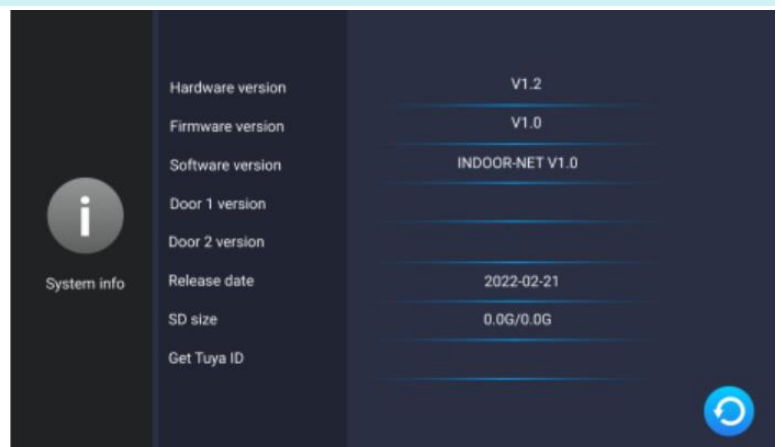



9. IP CAMERA CONNECTION

WIRED CONNECTION

Note: make sure the IP camera you want to connect supports the ONVIF protocol.

1. Connect the IP camera to the router using a Cat.5e network cable, and then connect the computer to the same router. Make sure the camera and the computer are on the same subnet.
2. Download and install the dedicated camera application to activate the IP camera. Refer to the manual of your chosen IP camera for installation details. **Note:** after activation, remember the camera's IP address, password and administrator name.
3. open the camera's configuration panel by typing the IP number of the camera in the browser window and confirming with the administrator password. In the configuration panel, enable the ONVIF protocol and set the video transmission settings to 1920*1080 @ H.264. **Note:** the video doorphone system supports the transmission of maximum resolution of 1080P/2MP.
4. After configuring the IP camera, make sure the monitor is connected to the Wi-Fi network and is on the same subnet as the IP camera.

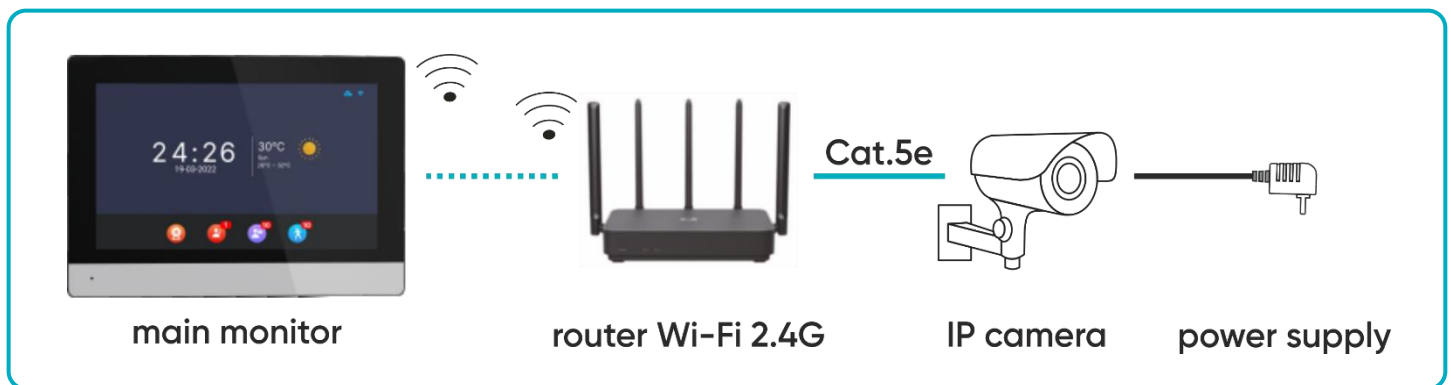
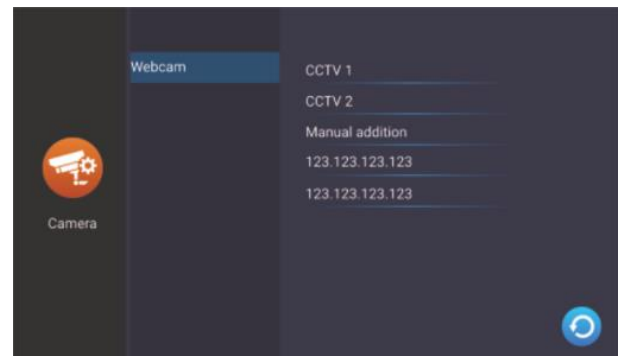
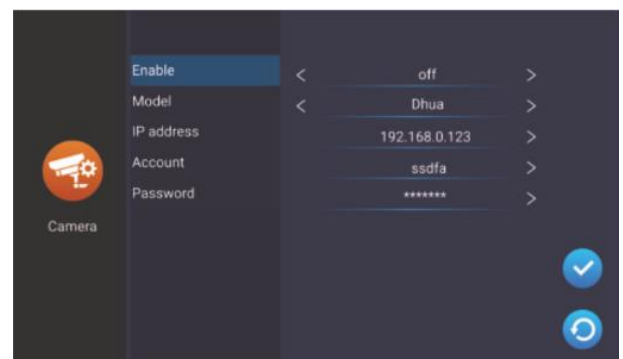

fig. 9 Connection scheme for the monitor and wired IP camera.

5. On the monitor in the main menu, select Settings and then Camera to display IP camera settings. The monitor will automatically start searching for the camera. If the camera supports the ONVIF protocol, its IP address will be displayed on the monitor:



6. Tap on the IP address of the camera to open the configuration menu. Fill in the administrator's name and password to complete the camera configuration.





WIRELESS CONNECTION

Note: make sure the IP camera you want to connect supports the ONVIF protocol and has the function of wireless connection via Wi-Fi.

1. Configure the wireless IP camera according to the instructions of the chosen camera. Be sure to enable the ONVIF protocol in the configuration panel.
2. Install the dedicated IP camera app on your phone and complete the configuration.
3. connect all devices to the Wi-Fi network. Make sure that the camera, the monitor, and the phone with the camera app installed are on the same subnet.

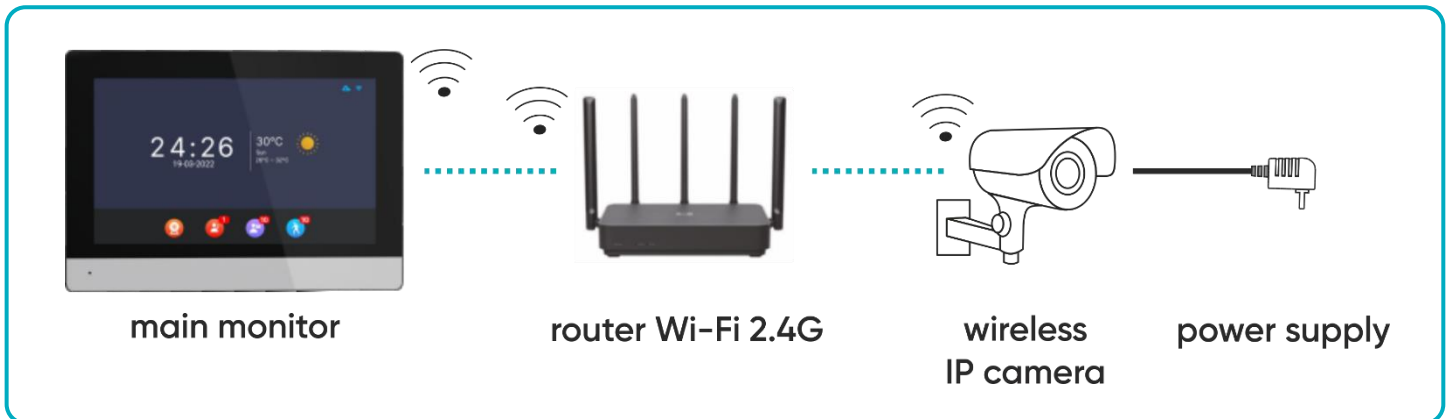
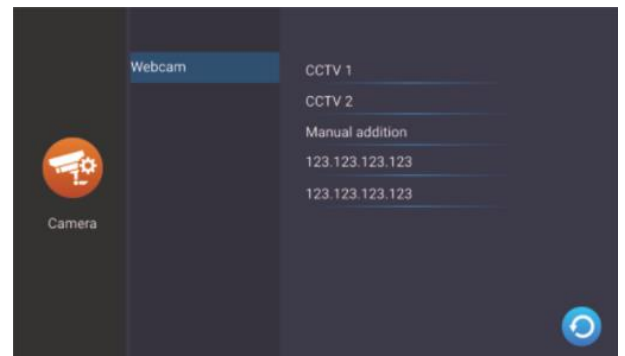
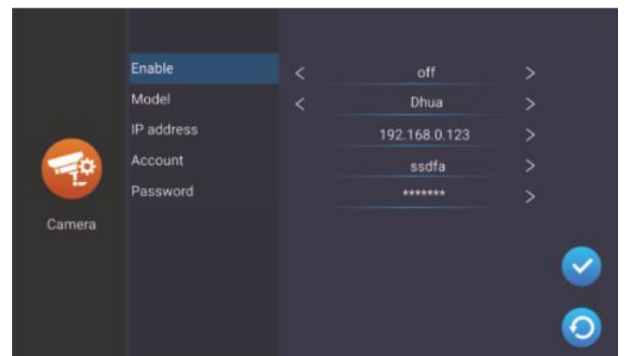

fig. 10 Connection scheme for the monitor and wireless IP camera.

5. On the monitor in the main menu, select Settings and then Camera to display IP camera settings. The monitor will automatically start searching for the camera. If the camera supports the ONVIF protocol, its IP address will be displayed on the monitor:



6. Tap on the IP address of the camera to open the configuration menu. Fill in the administrator's name and password to complete the camera configuration.





10. MOBILE APP INSTALATION

LOGIN

Note: a device can only be paired with one Tuya account. To pair the device with a new account, remove the pairing with the previous account or use the share function in the app to make the device available for a second account.

1. Open the App Store (iOS) or Google Play (Android) on your phone. Search for the app "Tuya Smart" and install it or scan the QR code.



2. If you do not already have an account in the app, click *Sign up*, you will be redirected to the next page. The system will automatically identify the country/region you are from or you can manually select it yourself. Enter your e-mail address, check your agreement with the privacy policy and click on *Receive verification code*. Enter the code you received, then enter your password and click *Go to app*.

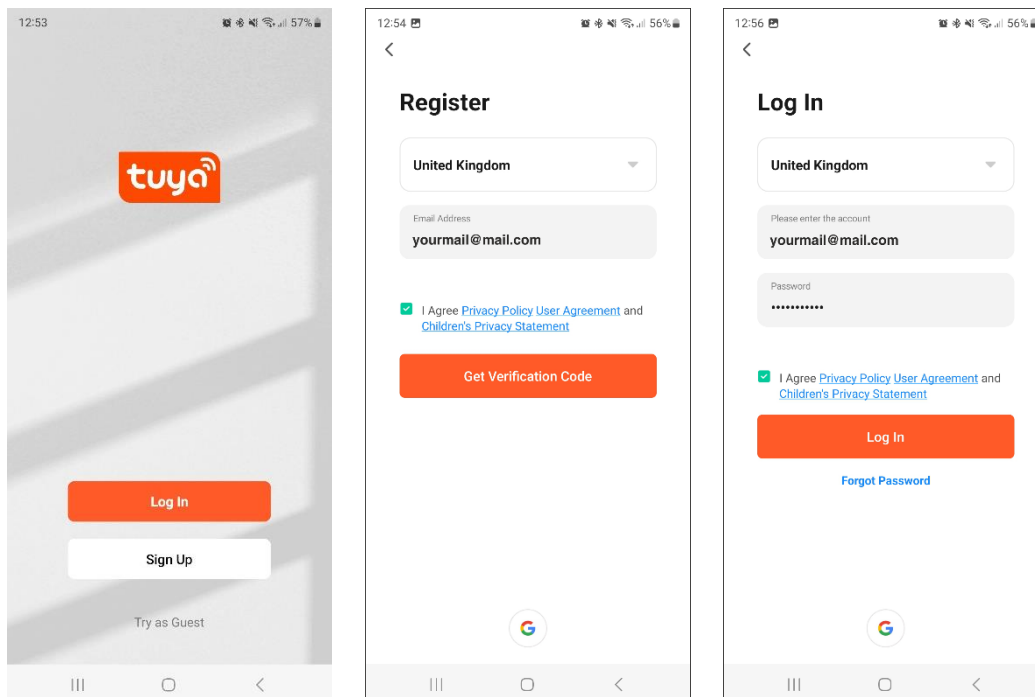

PAIRING THE DEVICE WITH THE PHONE

1. Connect the monitor to a Wi-Fi network. To do this, go to *Settings>Network* and then select *EZ mode* and connect the monitor with the desired Wi-Fi network. Once connected to the Wi-Fi network, select the *QR code* tab and scan it to connect the monitor with the app. **Note:** make sure your phone and the monitor are connected to the same Wi-Fi network.

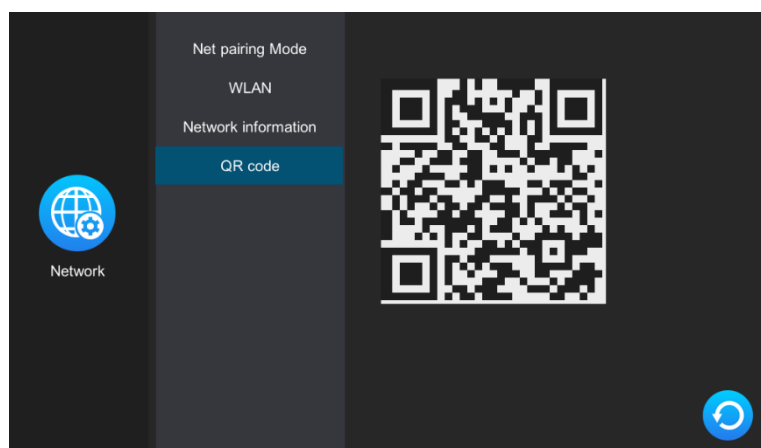



2. In the app on your phone, click *Add device* and then click the *Scan* icon located in the upper right corner. Scan the QR code displayed on the monitor to start the process of pairing the device with your phone.

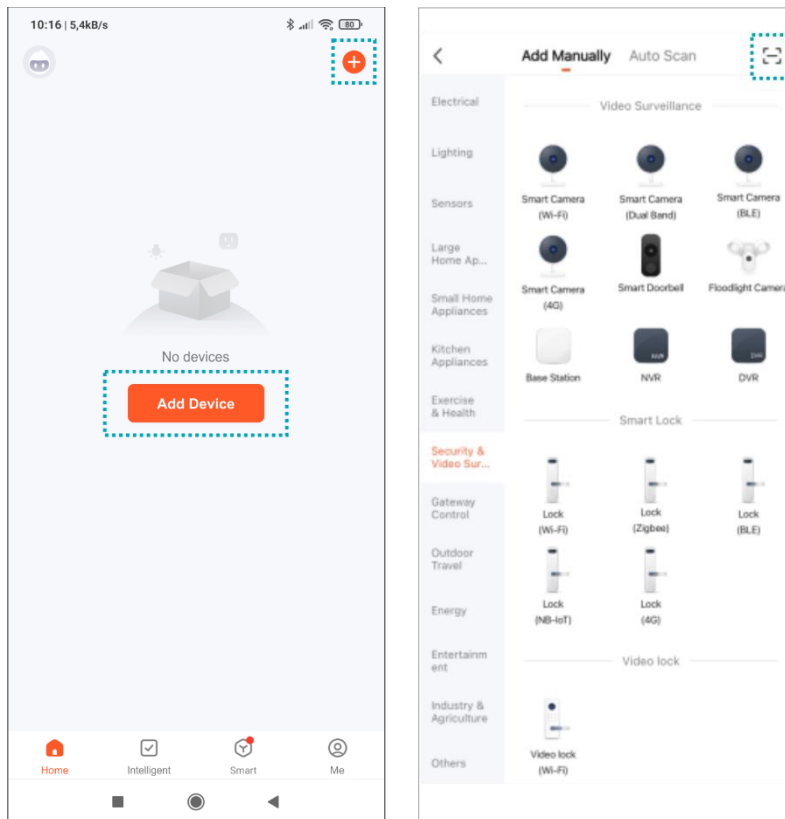

3. Be patient, the pairing process can take about 60 seconds. When it's finished, try to go to the external camera view to check if the connection is correct.

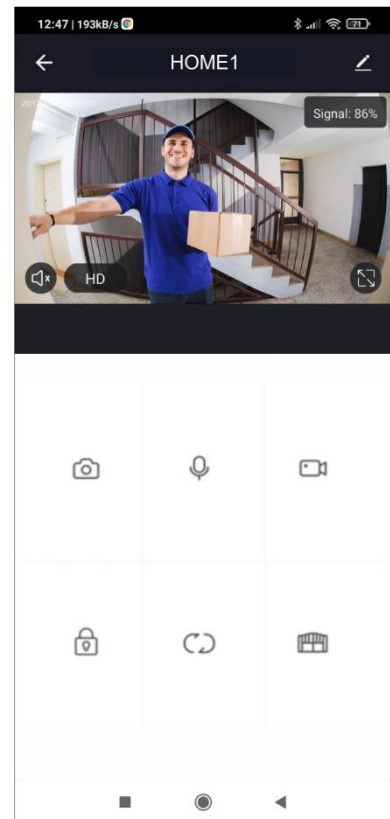
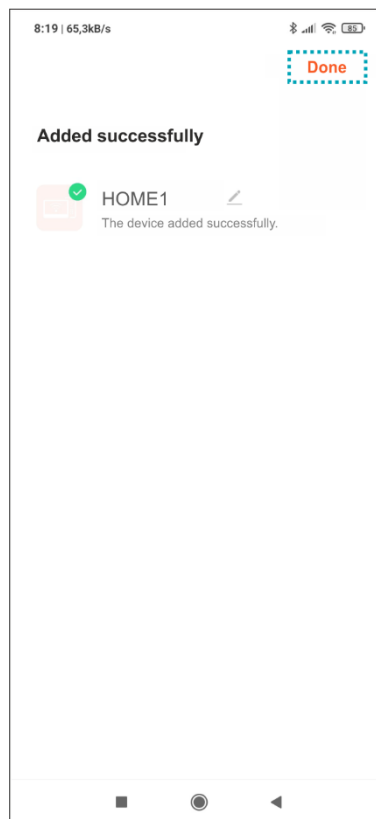
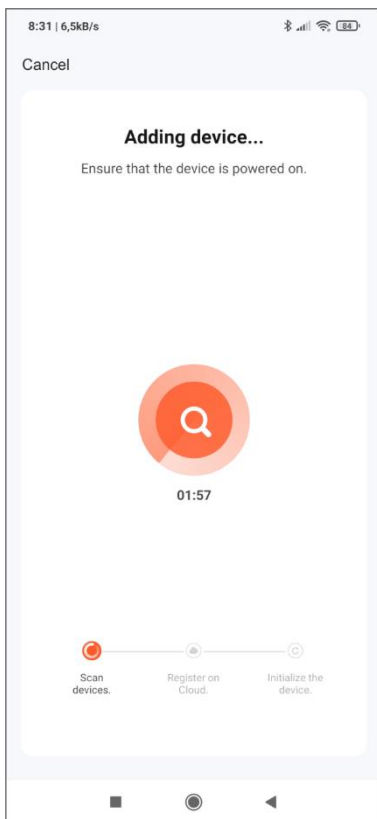



INVITING USERS

1. Select the *Me* tab on the bottom bar of the app, then enter *Home management>My Home*. Here, give the family a name (e.g. the Smiths).
2. Select *Add members*. On the app screen, options of sharing the invitation code will appear (e.g. text message). Invited users can add their device by entering the invitation code in *Home management>Join a home* - once the app is installed.

Note: the device can be shared with up to 20 people, including the administrator.

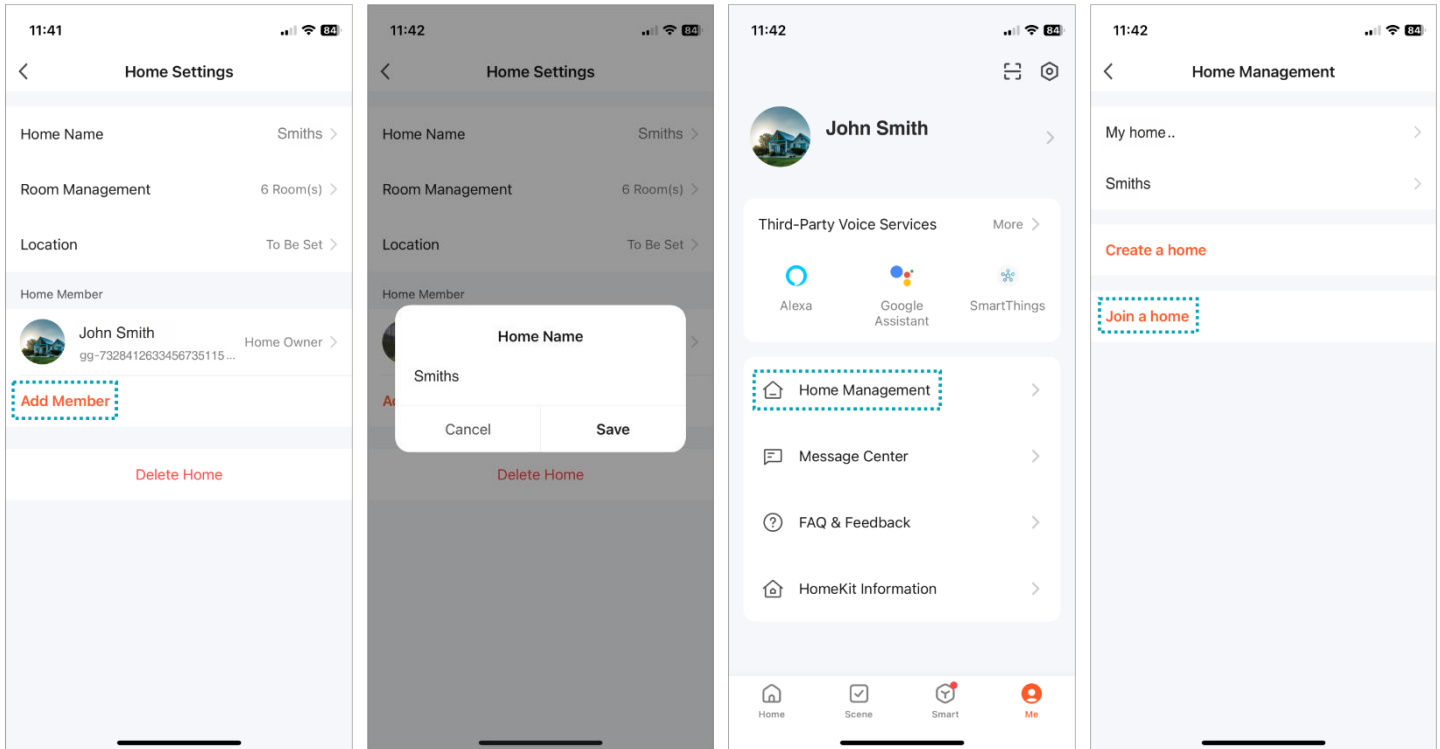

Note: in case the device is returned or sent for service repair, the device must be restored to factory settings and removed from the application.

Note: to ensure the correct functioning of the application, the user is obliged to update the application in accordance with communications from the application operator.

11. CLEANING AND MAINTENANCE

- The monitor should not be placed in a location exposed to high temperatures, in direct sunlight or high humidity locations (e.g. bathrooms),
- the monitor should not be placed near a television set or other objects that may cause interference to the signal,
- do not touch the device with wet hands,
- clean the camera lens with a dry cloth, do not use chemical cleaners,
- do not place the camera in direct sunlight,
- before installing the device in the chosen place, make sure that there is no signal interference,
- avoid switching off the device during recording, data may be lost.



12. TROUBLESHOOTING

1. No audio/video, no indicator light

- a) no supply voltage,
- b) damaged or incorrectly connected connecting cable, check your installation for technical requirements page 4-5,
- c) check that the installation is not exposed to water, moisture etc.,
- d) check that the camera lens is not obstructed by an object that prevents proper view.

2. No video but audio is normal

- a) check that all connections are made correctly with regard to technical requirements,
- b) check that the camera lens is not obstructed by an object that prevents proper view.

3. No audio when calling

- a) ensure that the monitor volume is not set to the lowest setting,
- b) ensure that there are no objects in the vicinity of the device that could cause interfering with the signal,
- c) check that all connections are made correctly with regard to technical requirements.

4. Outdoor unit cannot call the monitor

- a) check that all connections are made correctly with regard to technical requirements.



5. Electric door strike not working

- a) check the independent operation of the electric door strike by connecting it to the required voltage, etc.

6. Cannot hear the visitor when answering a call

- a) press the  button to activate two-way intercom,
- b) check that all connections are made correctly with regard to technical requirements.

7. You can hear the visitor when you receive a call, but you cannot answer them

- a) press the  button to activate two-way intercom (pressing the  button on the monitor, the outdoor unit cannot hear the indoor unit),
- b) check that all connections are made correctly with regard to technical requirements.



ORNO-LOGISTIC Sp. z o.o.
ul. Rolników 437, 44-141 Gliwice, Poland
tel. (+48) 32 43 43 110, www.orno.pl
NIP: 6351831853, REGON: 243244254

Simplified declaration of conformity

Orno-Logistic Sp. z o.o. declares that the type of radio device OR-VID-MA-1079/B Video doorphone set Xiran is compliant with the Directive 2014/53/EU. The full text of the EU declaration of conformity is available at the following web address: www.orno.pl.