

ViRONE

Operating and installation instructions

Video doorphone set ACERO

VDP-71



CE STOP!

Be sure to read the instruction manual before installation!
Damage resulting from incorrect connection
ARE NOT SUBJECT TO REPAIR UNDER WARRANTY!

TABLE OF CONTENTS

1. SAFETY INSTRUCTIONS.....	2
2. CHARACTERISTICS OF THE SET	3
3. TECHNICAL DATA	3
MONITOR.....	3
OUTDOOR UNIT	4
4. SET CONSTRUCTION	4
MONITOR.....	4
OUTDOOR UNIT	4
5. INSTALLATION.....	5
MONITOR INSTALLATION.....	5
OUTDOOR UNIT WITH CAMERA INSTALLATION.....	5
6. WIRING DIAGRAMS.....	6
7. SET OPERATION	8
MAIN MENU	8
MONITORING	9
CALL VOLUME AND IMAGE ADJUSTMENT	10
CONNECTION	10
9. CCTV	10
10. INTERCOM.....	11
11. PLAYBACK.....	12
IMAGE	12
VIDEO.....	13
12. SETTINGS.....	13
RECORDING	13
VOLUME	15
STORAGE	16
DATE AND TIME.....	16
DISPLAY	17
ETC	19
SD CARD.....	20
13. CLEANING AND MAINTENANCE.....	20
14. TROUBLESHOOTING	21

1. SAFETY INSTRUCTIONS

Before using the device, read this Service Manual and keep it for future use. The manufacturer is not responsible for any damage that can result from improper device installation or operation. Any repair or modification carried out by yourselves results in loss of guarantee. Installation and commissioning of the equipment by the customer are possible if the installer has basic knowledge of electrical systems and the use of proper tools. In view of the fact that the technical data are subject to continuous modifications, the manufacturer reserves a right to make changes to the product characteristics and to introduce different constructional solutions without deterioration of the product parameters or functional quality. Additional information about ORNO products is available at www.orno.pl. Orno-Logistic Sp. z o.o. holds no responsibility for the results of non-compliance with the provisions of the present Manual Orno Logistic Sp. z o.o. reserves the right to make changes to the Manual - the latest version of the Manual can be downloaded from www.orno.pl Any translation/interpretation rights and copyright in relation to this Manual are reserved.

1. Disconnect the power supply before performing any activities.
2. Do not immerse the product in water or other liquids.
3. Do not operate the device with damaged housing.
4. Do not break the seals or open the device and do not repair it yourself.
5. Do not use the device contrary to its dedication.
6. Do not install the monitor near devices with strong magnetic field like TV, speakers.
7. Do not install the monitor in a place exposed to high moisture, vibration, shock and strong sunlight.
8. Turn off the power if there is a concerning sound coming from the device.
9. After installation and mounting, remove the protective film from the monitor screen.



Each household is a user of electrical and electronic equipment, and hence a potential producer of hazardous waste for humans and the environment, due to the presence of hazardous substances, mixtures and components in the equipment. On the other hand, used equipment is valuable material from which we can recover raw materials such as copper, tin, glass, iron and others. The WEEE sign placed on the equipment, packaging or documents attached to it indicates the need for selective collection of waste electrical and electronic equipment. Products so marked, under penalty of fine, cannot be thrown into ordinary garbage along with other waste. The marking means at the same time that the equipment was placed on the market after August 13, 2005. It is the responsibility of the user to hand the used equipment to a designated collection point for proper processing. Used equipment can also be handed over to the seller, if one buys a new product in an amount not greater than the new purchased equipment of the same type. Information on the available collection system of waste electrical equipment can be found in the information desk of the store and in the municipal office or district office. Proper handling of used equipment prevents negative consequences for the environment and human health!

2. CHARACTERISTICS OF THE SET

Videodoorphone is designed for installation in 1-family buildings.

Functions:

- simultaneous view and hold of a conversation with a person in front of an entrance;
- direct control of an electric door strike;
- gate control;
- stepless adjustment of monitor parameters (image brightness, colour saturation, volume)
- bright white LED lighting allowing night vision;
- screen carousel;
- intercom function when additional monitors are used.

Key features:

- large 7" LCD color monitor;
- 6 ring tones to choose from with volume control;
- touchscreen;
- outdoor unit with wide-angle Full HD camera;
- the possibility to record photos, sounds and videos on a microSD card and play them back on the monitor;
- 4-wire installation;
- set can be expanded to include two outdoor units, two CCTV cameras and four monitors.

3. TECHNICAL DATA

TYPE OF THE DEVICE:	single family
INSTALLATION METHOD:	4-wire
COMMUNICATION SYSTEM:	wired

MONITOR

SCREEN SIZE:	7"
RESOLUTION:	1024x600x3RGB
STANDARD:	PAL
FUNCTIONS:	call, monitoring, door and gate control, answering machine, monitor and volume control, mute mode, intercom, screen carousel
NUMBER OF MELODIES:	6
VOLUME CONTROL:	yes
CALL TIME:	60s
MONITORING TIME:	30s
POWER SUPPLY:	15V DC 1A
POWER CONSUMPTION:	standby <2,8W; work <5W
ELECTRICAL STRIKE CONTROL:	yes (12V DC max. 300mA – powered from monitor)
GATE CONTROL:	yes (dry contact)
WORKING TEMPERATURE:	-20°C ~ +50°C
INSTALLATION:	surface-mounted
MATERIAL:	plastic
DIMENSIONS:	182x125x27mm
NET WEIGHT:	0,318kg

OUTDOOR UNIT

SENSOR TYPE:	CMOS 1/2.9"
RESOLUTION:	1080P FHD
VIEWING ANGLE (VERTICAL/HORIZONTAL):	46° / 93°
NIGHT LIGHTING:	white LED diodes
NUMBER OF DIODES:	5
NIGHT VISION RANGE:	≤1m
MOTION SENSOR:	yes
INGRESS PROTECTION:	IP44
POWER SUPPLY:	15V DC from monitor
POWER CONSUMPTION:	standby <0,5W, work <3W
WORKING TEMPERATURE:	-20°C ~ +50°C
INSTALLATION:	surface-mounted
MATERIAL:	aluminum
DIMENSIONS:	64x153x46mm
NET WEIGHT:	0,307kg

4. SET CONSTRUCTION



fig. 1 Construction of the monitor and the outdoor unit

MONITOR

1. LCD touchscreen
2. Microphone
3. Holes for the mounting bracket
4. Connection terminals
5. Power supply terminal
6. Loudspeaker
7. MicroSD card slot

OUTDOOR UNIT

8. Rainshield
9. Night-time lighting
10. Camera lens
11. Loudspeaker
12. Nameplate
13. Call button
14. Microphone
15. Indicator light

5. INSTALLATION

MONITOR INSTALLATION

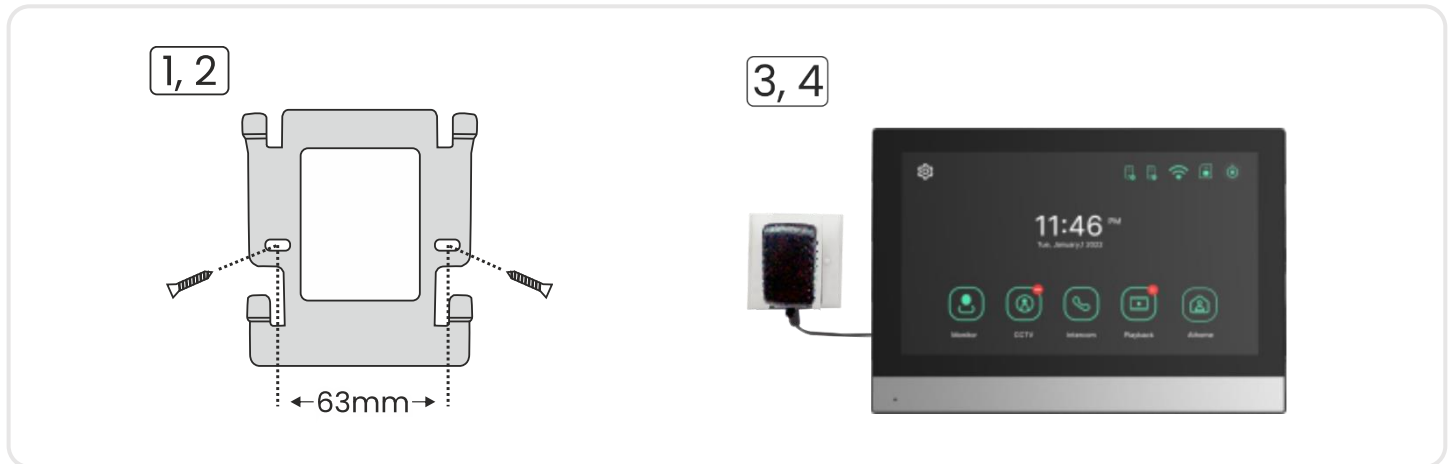

fig. 2 Monitor installation

1. Drill holes in the wall and insert silicone dowels into them.
2. Screw the monitor mounting bracket to the wall with screws.
3. Connect the wires to the monitor and hang it on the mounting bracket.
4. Connect the power supply to the 230V AC outlet.

OUTDOOR UNIT WITH CAMERA INSTALLATION

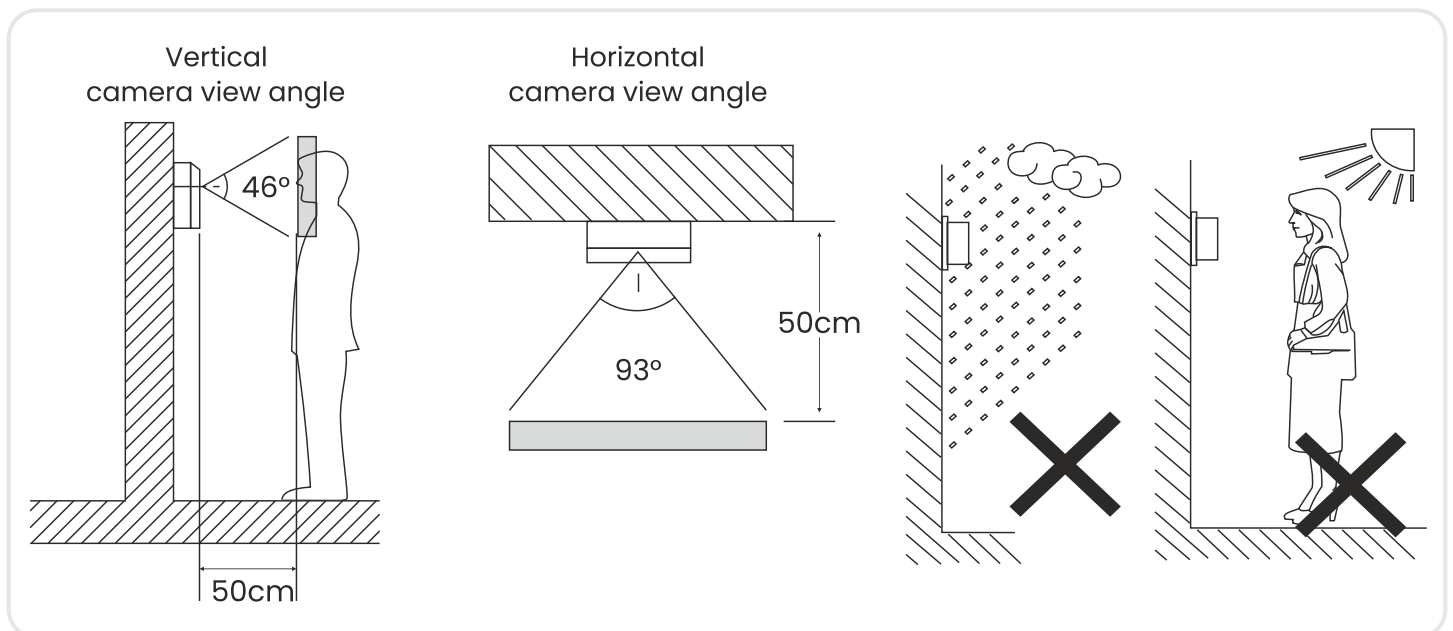

fig. 3 Outdoor unit placement

Recommended installation height of the outdoor unit is 140–170cm.

The correct location of the outdoor unit determines the comfort of working with the device. It is recommended to test the device before making mounting holes. Do not place the outdoor unit and monitor in the same room as feedback may occur.

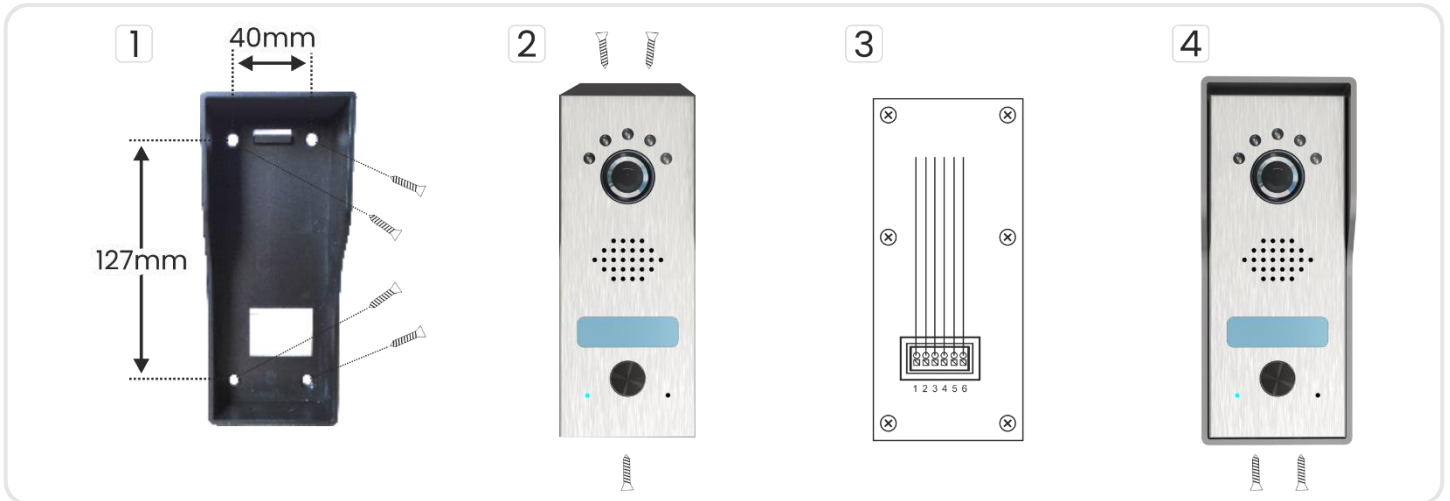

fig. 4 Outdoor unit with camera installation

1. Drill holes in the wall and insert the silicone dowels. Pull through the wires and screw the rainshield into place using screws.
2. Remove the screws located on the top and bottom of the outdoor unit and pull off the metal cover. Write down your name on the nameplate and tighten the cover back to the panel.
3. Connect the wires according to the wiring diagram and place the outdoor unit in the rainshield.
4. Secure the outdoor unit by screwing in two security screws from below.

6. WIRING DIAGRAMS

Before drilling the installation holes, it is recommended to carry out a functional test of the device. To do this, connect the device for a test according to the wiring diagram. The first person holding the camera should use the button to call the second person who is at the monitor. This person should then carefully inspect the camera's field of view in order to correct the module's position if necessary. Once the measurements have been taken accurately, proceed with the mounting holes after switching off the power supply.

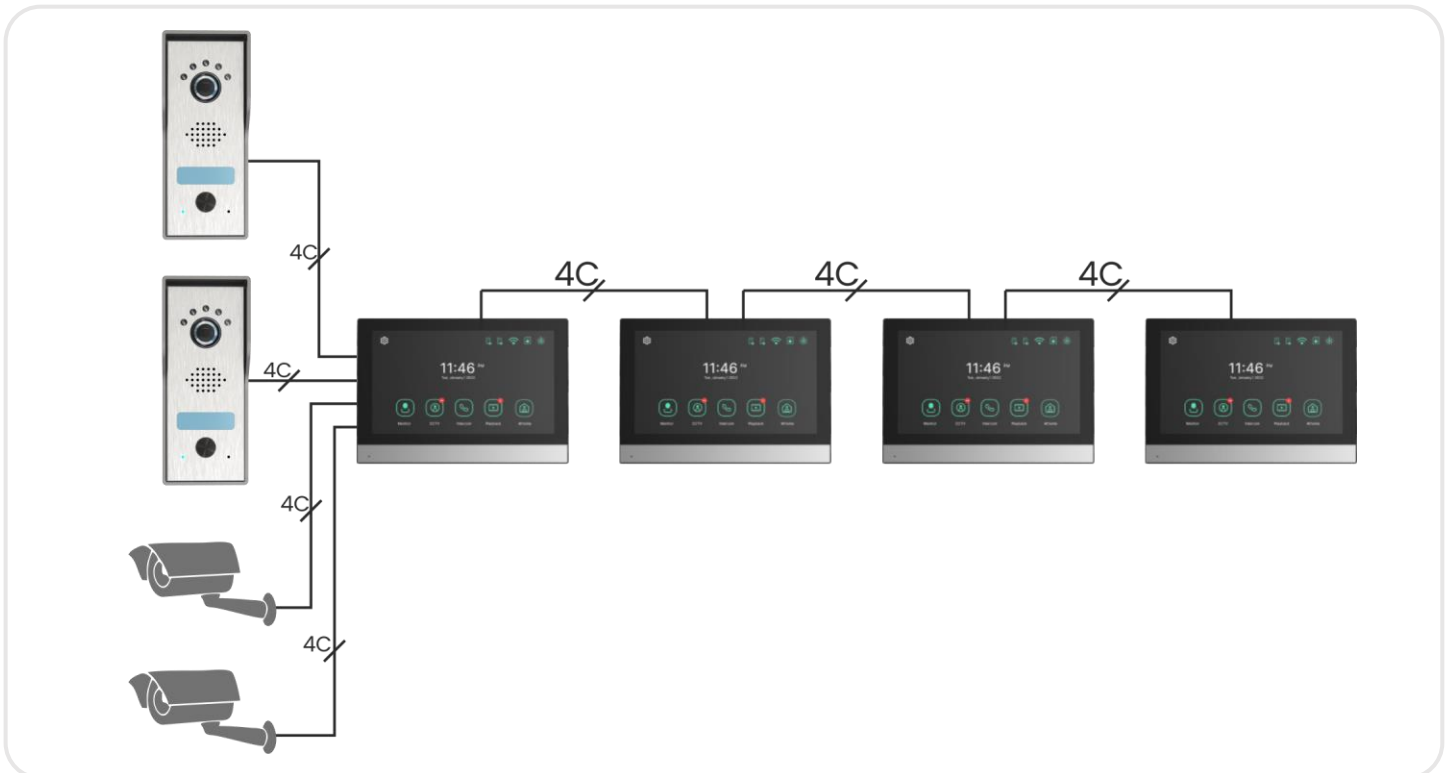

fig. 5 Wiring diagram

It is forbidden to make connections to live equipment! Failure to adhere to this recommendation may result in permanent damage to the device and loss of health.

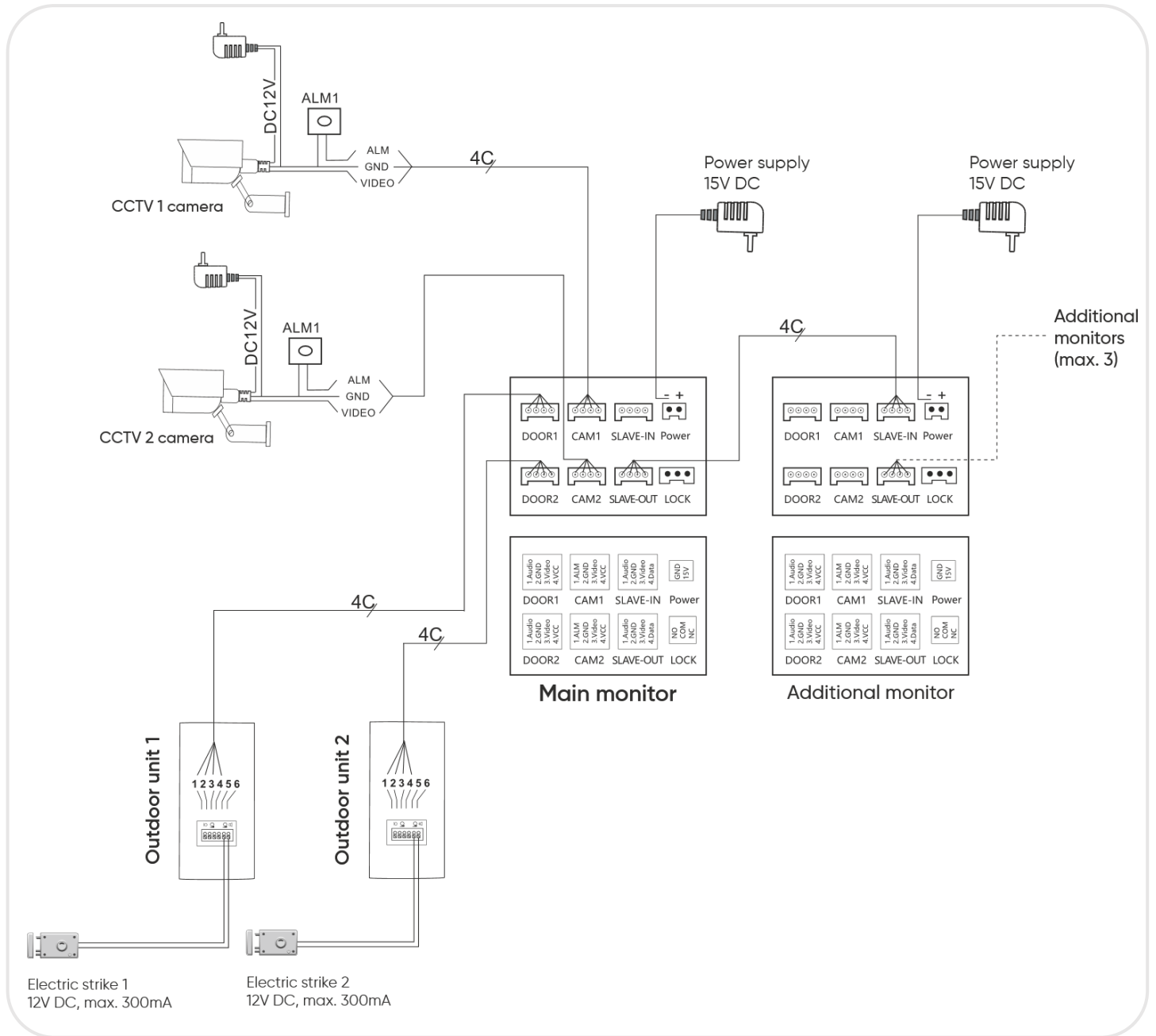

fig. 6 Wiring diagram

! The set does not include an electric door strike and automatic gate control unit!

The video doorphone cables should not be routed in one cable with the cables of other installations such as bell, alarm, etc. Any power and telecommunication cables emitting strong magnetic fields (e.g. loudspeaker columns, TV set) in direct contact with the cables connecting the outdoor unit to the monitor may adversely affect the operation of the set.

If the user has other connection cables than the recommended ones, it is allowed to use them, however, it is necessary to make a test connection of the set in order to check its correct functioning.

When designing the electrical installation, take into account the appropriate cable cross-section:

- up to 30m - recommended cable XzTKMXpw 3 x 2 x 0,5mm
- from 30m to 100m - recommended cable XzTKMXpw 3 x 2 x 0,8mm

The connection to the electromagnetic lock should be made with 2 x 1mm² cable.

The set is compatible with any electric door strike with 12V DC supply voltage and current consumption of max. 300 mA.

The total length of the installation must not exceed 100 metres.

We absolutely do not recommend the use of twisted-pair cables.

7. SET OPERATION

MAIN MENU

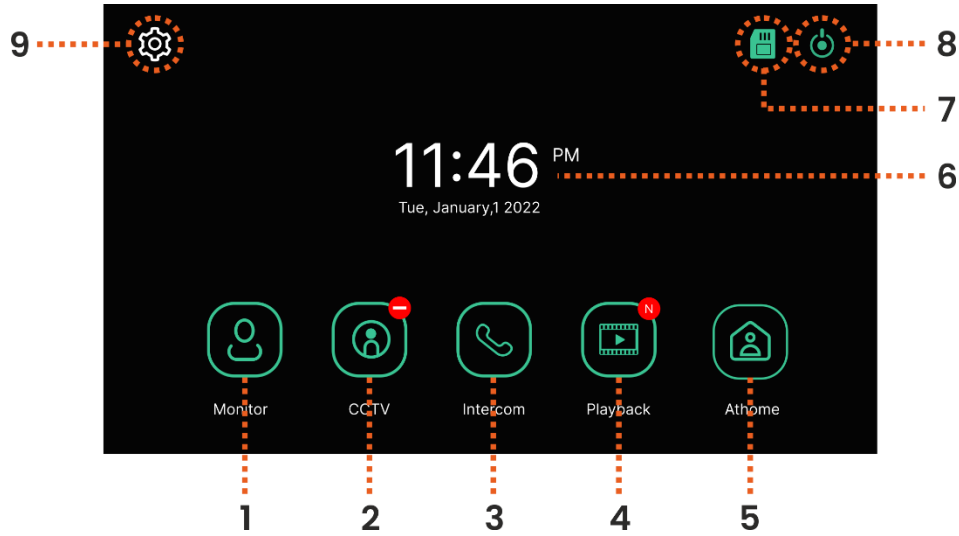

1	Monitor	Outdoor unit camera view.
2	CCTV	CCTV camera view.
3	Intercom	Intercom function (available with additional monitors connected).
4	Playback	Display a list of recorded photos and videos.
5	Operating mode	Three possible settings: at home/ away/ do not disturb. At home: call and conversation available, Away: option of leaving a message by a visitor, Do not disturb: monitor and outdoor unit muted.
6	Date and time	Current date and time – press to edit.
7	SD card status	Indicator of installed SD card.
8	Monitor turn off	
9	Settings	Go to the settings menu.

Important: Remember to set the date and time before using the device. If you do not set the date/time, problems may arise when saving images and videos.



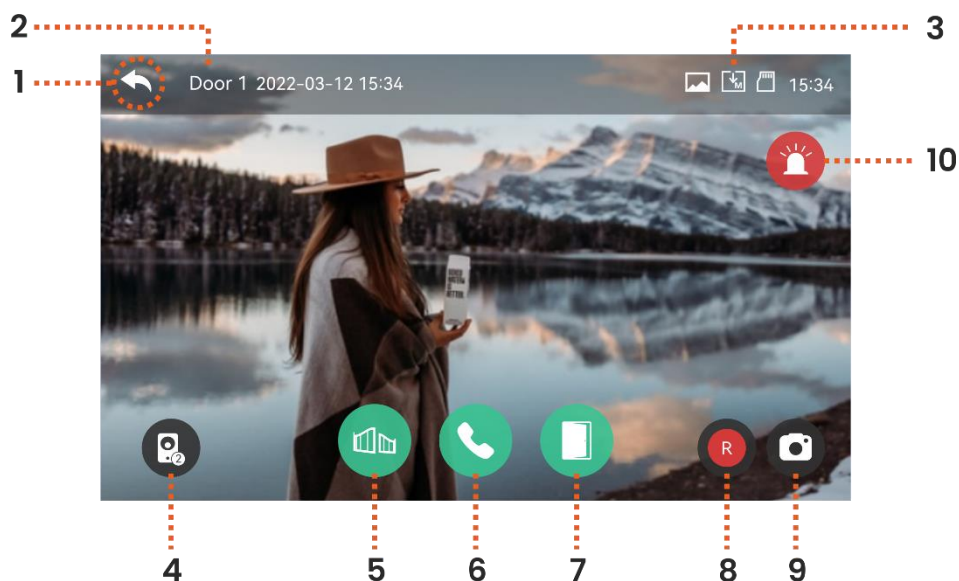



MONITORING



1 Go back to the previous page.

2 Door 1: indicates the active camera from which the image is displayed on the screen.

Recording status icons:

- 3
- | | | |
|---|---|--|
|  |  | Recording format: Photo/Video (in motion detection mode) |
|  |  | Recording mode: MANUAL/AUTO |
|  |  | SD card status: Inserted/Memory full |

4 Change the preview to the second external panel. Function only available when a second external panel is connected.

5 Gate control: press to open the gate.

6 Answer call: press to answer the call. During the call it changes to End call.

7 Open door/wicket: press to release the electric door strike and open the door/wicket.

8 Video recording: press to start recording (in AUTO mode, video is automatically recorded when motion is detected in the detection field). The length of the recording is a maximum of 60 seconds. After you start recording, the remaining time will be displayed in the upper right corner. Press the icon again to stop recording.

9 Take a picture: press to take a picture of the view from the external camera.

10 Alarm: press to activate the alarm on the outdoor unit.

Preview time: 30 seconds

Call and conversation time: 60 seconds

CALL VOLUME AND IMAGE ADJUSTMENT

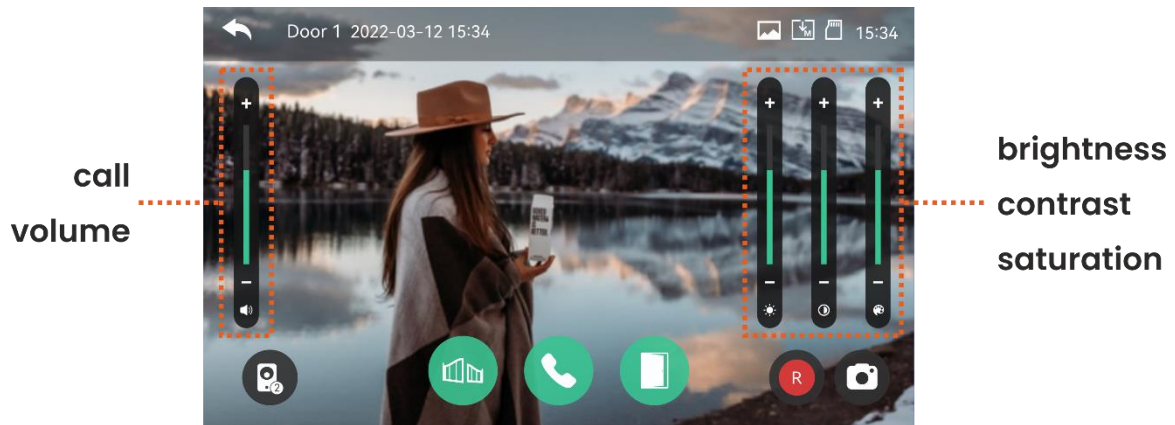

During monitoring or a call, press any area of the image to enter the call volume/ image brightness/ image contrast/ colour saturation adjustment window.

CONNECTION

1. When the Call button on the outdoor unit is pressed, the monitor beeps and the image from the external camera is displayed on the screen. The ringing time is max. 20 seconds. When AUTO mode is activated, the video/photo is automatically saved.
2. When the Answer call button is pressed, the conversation can be started. The conversation time is max. 60 seconds. During the call, the door/gate can be opened.
3. When another call comes in from the second outdoor unit, a new call will be started only when the current call ends.
4. When the End call button is pressed, the conversation ends. The monitor returns to the main screen.

9. CCTV

When the CCTV icon is pressed, the image from the connected CCTV camera is displayed on the monitor screen. The viewing time is max. 60 seconds. During the preview, you can start recording. The CCTV monitoring function is only available if the camera is correctly connected to the set.

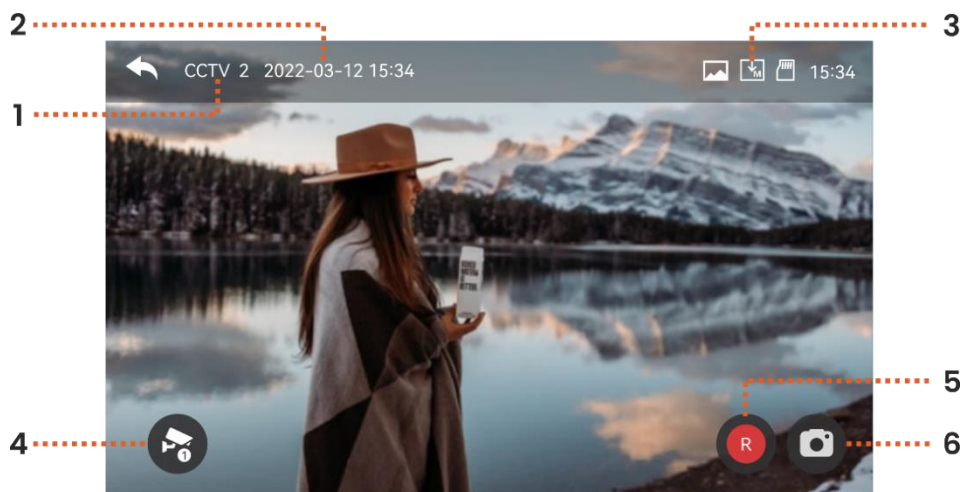

- 1 Indicates the active CCTV camera from which the image is displayed on the screen.
- 2 Current time and date.
- 3 Recording status icon (shows current format and recording mode).
- 4 Possible change of view to image from CCTV camera 2 (if installed).
- 5 Video recording: press to start recording the view from the CCTV camera. During recording, the remaining time will be displayed in the upper right corner. Press again to stop recording.
- 6 Take a picture: press to take a picture of the CCTV camera view.

Important: Videos cannot be saved and stored unless an SD memory card is installed in the device. Pictures can be saved in the device's memory (capacity - maximum of 30 images).

1. Turn off the monitor. Place the SD memory card in the slot on the side of the monitor (max. card capacity 128GB). Switch on the monitor. All images stored in the device's memory will be automatically transferred and saved to the memory card.
2. All saved files can be viewed on a computer ([media] folder on the memory card).
3. Each file can be checked for date, recording time, source (from which camera the video/photo was recorded) and its format can be checked.

File name: YYMMDD_HHMMSS_AB.AVI or JPG (year/month/day_hour/minute/second_)

Note: Meaning of the last two digits (marked AB):

A: 1 - DOOR1 / 2 - DOOR2 / 3 - CCTV1 / 4 - CCTV2

B: 1 - MANUAL (manual recording) / 2 - AUTO / 3 - MOTION SENSOR / 4 - ALARM

Example: file name: „180109_045740_12.avi“

Video recorded automatically, triggered by visitors using the Call button on Door 1, on 9 January 2018, at 4:57:40.

10. INTERCOM

Function available if more than 1 monitor is connected to the set.

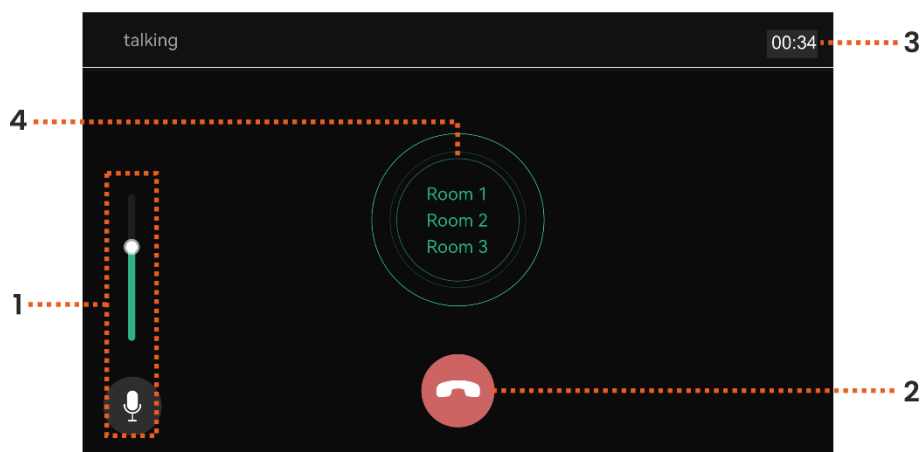

- 1 Volume control: 4-step adjustment of the call volume.
- 2 End call: press to end the call and switch off the intercom.
- 3 Call and conversation time: indicates the current time of the call or conversation.
- 4 Connection between monitors: select which device you want to connect to.

11. PLAYBACK

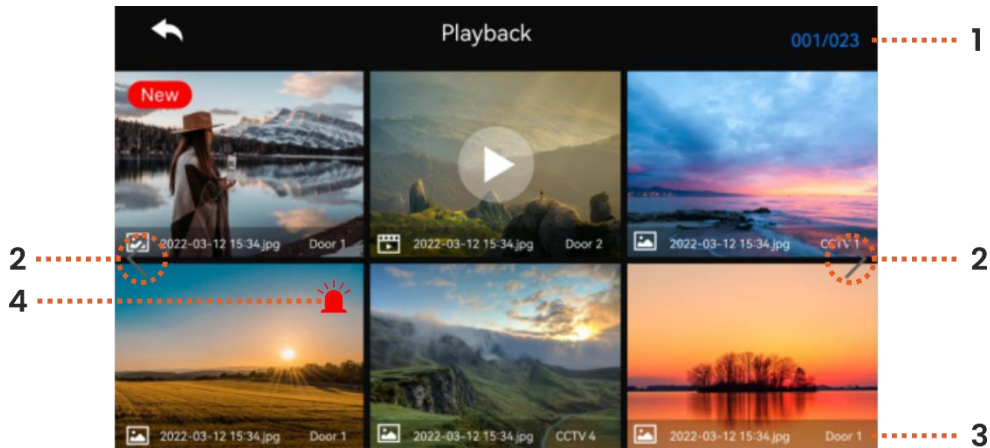

1 Current page/number of all pages.

2 Go to next page/go back to previous page.

3 File information.  Image  Video New New file

Alarm recording: file recorded when an alarm occurs.

If "Auto Recording" is selected in the security menu, the CCTV camera image is recorded for 10 seconds in the case of an emergency. If an SD memory card is not installed in the device, only the image is saved.

4 If a call is received from a visitor during an emergency, the video image is recorded automatically with the "Auto Recording" setting or can be recorded manually. During an emergency, communication with visitors is limited and only the camera image can be checked.

IMAGE

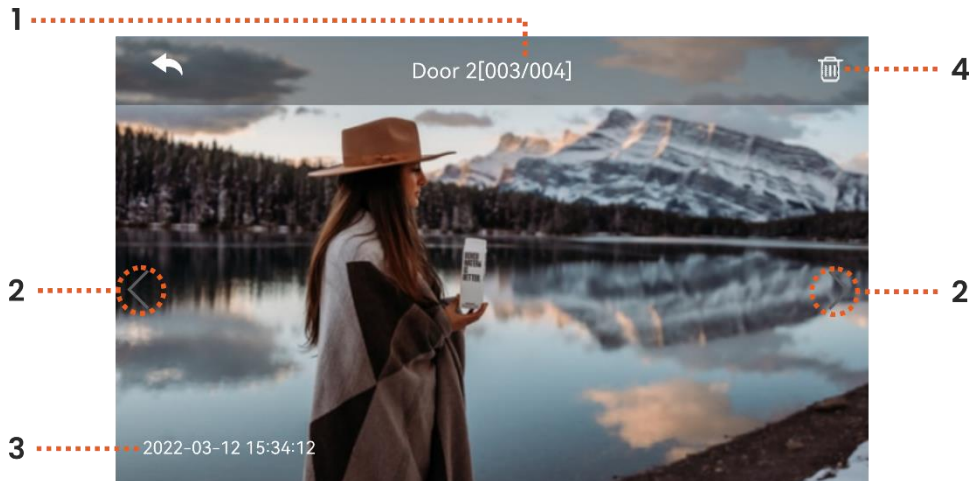

1 Source/file number.

2 Go to next/return to previous file.

3 Date and time.

4 Delete file.

VIDEO

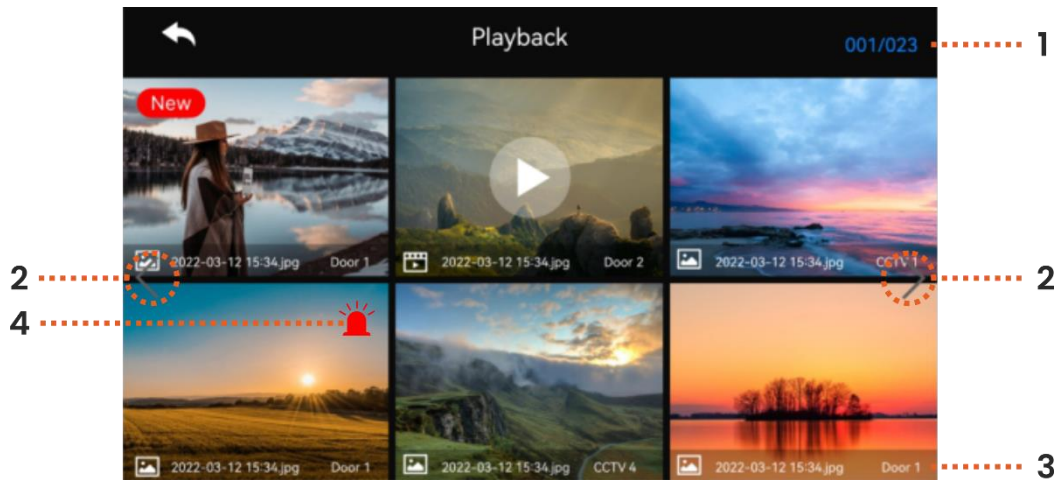

- 1 Source/file number.
- 2 Go to next/go back to previous video.
- 3 Play video - press to play the current video file.
During playback, the icon changes into a pause button.
- 4 Delete file.
- 5 Date and time.
- 6 Video file duration: the remaining time is displayed.

Note: After inserting the SD memory card into the device, wait for a while for the files on the card to load. The waiting time depends on the number and size of files stored.

12. SETTINGS

RECORDING

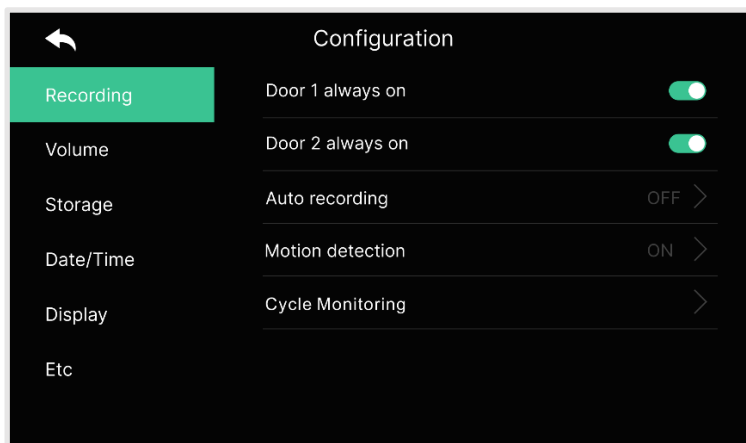

Door 1/Door 2 always on

Enable this option if the outdoor unit has a code lock or RFID reader and needs constant power supply.

Auto recording

Enable this option to set the autosave mode (photo/video). If an SD memory card is not installed in the unit, automatic video recording cannot be selected. This function is activated when the call button on the outdoor unit is pressed. When the function is activated, it is not possible to perform manual image/video recording until automatic recording is activated.

Motion detection

Activate the option to set motion detection for the previously set camera.

The motion detection functions are as follows:

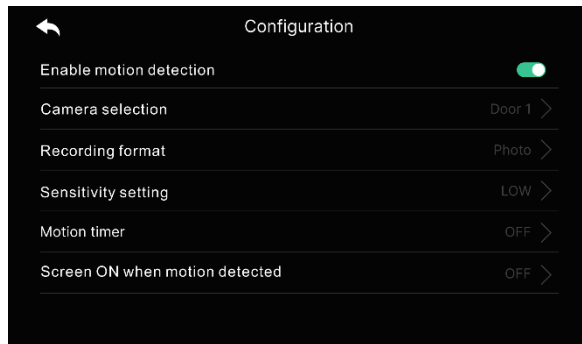

Enable motion detection: on/off.

Camera selection: select camera for monitoring the environment (door 1/2, CCTV camera 1/2 - if installed).

Recording format: select image/video.

Sensitivity setting: detection sensitivity high/medium/low.

Motion timer: select to activate the timer function (motion detection activation time). Once activated, the start/end time of motion detection can be set.

Screen ON when motion detection: during video recording, the video is displayed on the monitor screen (for 60 seconds).

Cycle monitoring

Enable this option to have the system periodically monitor all outdoor units and CCTV cameras and automatically record the image/video. Select the cycle monitoring time for each outdoor panel or CCTV camera (10/30/60 seconds).

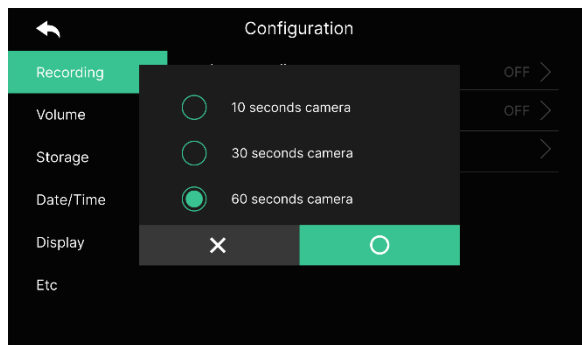

Important:

- When motion detection is activated, the unit takes 1 photo (1 shot) or records video for a duration of previously selected time (10/30/60s).
- At night or in a shaded area, the night-time lighting of the camera on the outdoor unit is permanently switched on when motion detection is activated.
- It is necessary to position the camera lens properly so that no false signals (e.g. the movement of random passers-by) appear in its range!

VOLUME

An individual ringtone can be set for each outdoor unit (6 melodies to choose).

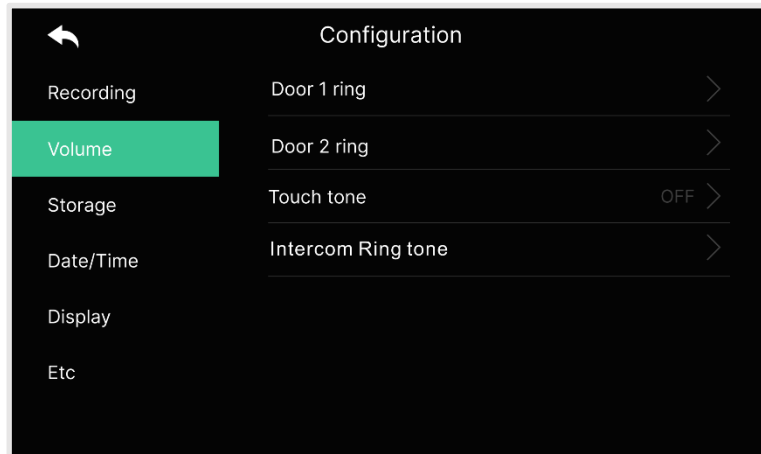

Door 1/Door 2

Option to set 3 different ringing schedules for 3 different time intervals (adjust the time interval for a given ring, the ringing time, the ringing mode and its melody and volume).

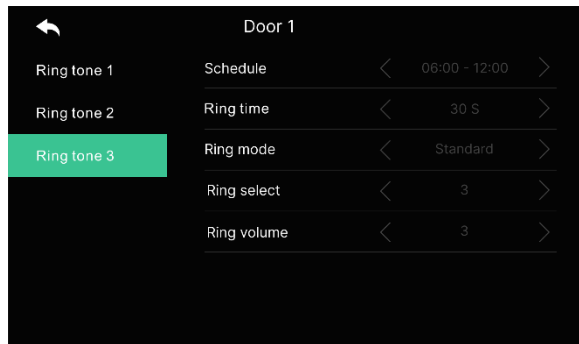

Touch tone On/off.

Intercom ringtone You can select one of the 6 available ringtones for internal calls between monitors (intercom).

STORAGE

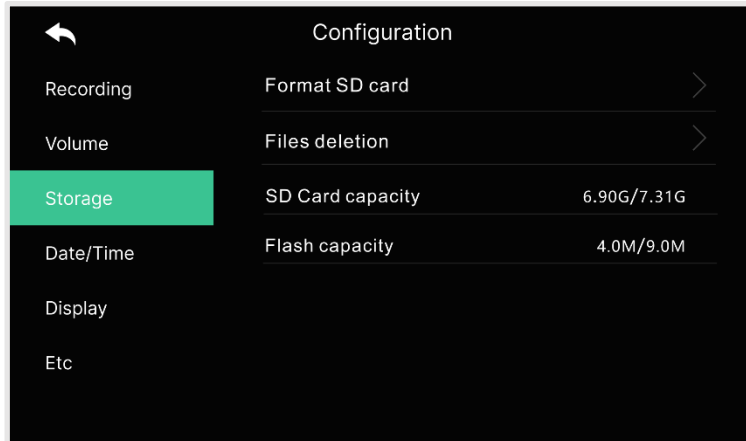

Format SD card Select to format the SD memory card. The process may take about 1 minute.

Files deletion Select the photos or videos you wish to delete.

SD card capacity Displays the free and total capacity of the SD card.

Flash capacity Displays the free and total memory capacity of the monitor.

Note: When formatting the SD card or deleting photos/videos, incoming calls are not forwarded!

DATE AND TIME

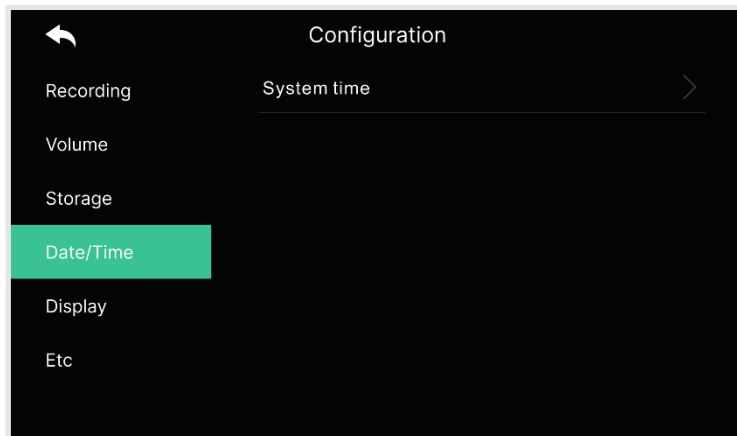

System time Set the current date and time that will be displayed on the home screen.

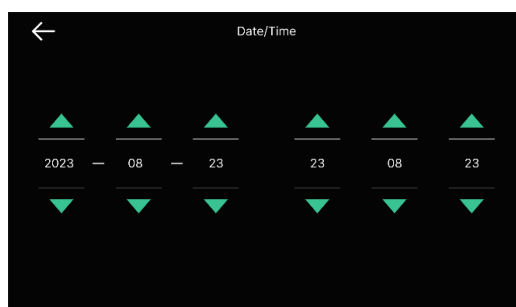

DISPLAY

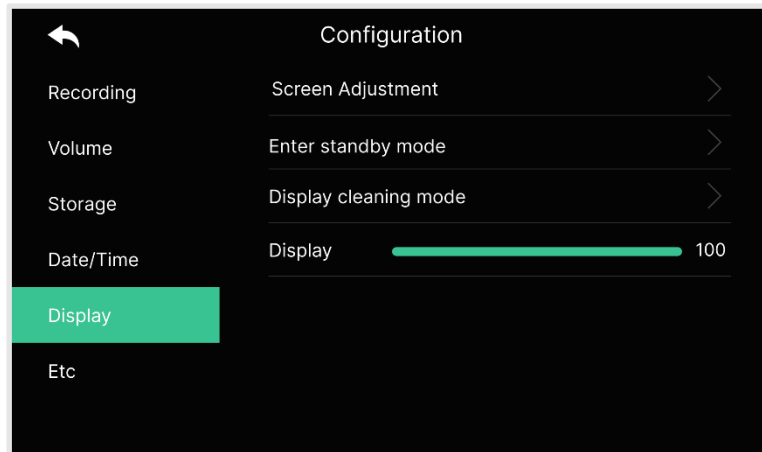

Screen adjustment

Brightness/contrast/colour saturation can be adjusted (settings apply to the image displayed from external camera). The settings can be adjusted from 0-20. Return to default settings by pressing the icon in the upper right corner.

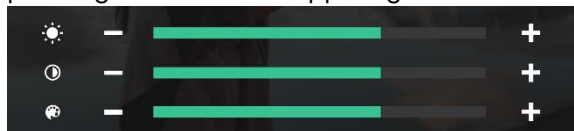

Enter standby mode

Choose from different standby modes.

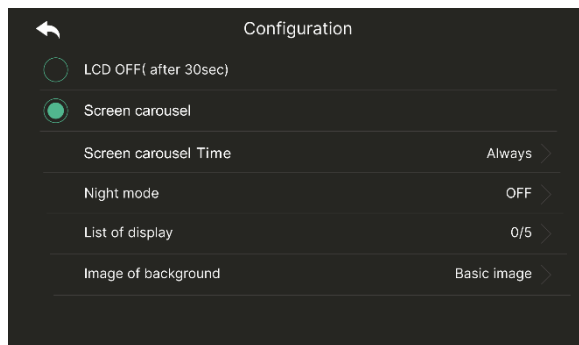

LCD off (after 30 seconds): the screen switches off after 30 seconds if no action was performed during this time.

Screen carousel: enable the screen carousel function after entering standby mode. Important: If motion detection and automatic recording are activated, the screen carousel cannot be activated!

Screen carousel time: the "loop playback" option can be turned on permanently or a specific time interval can be set for it to operate.

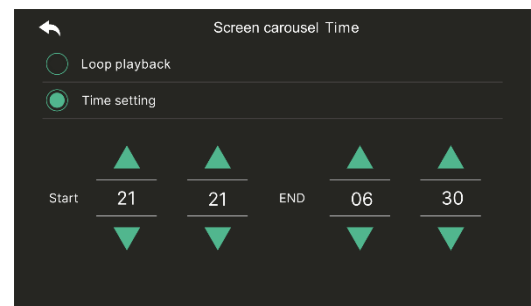
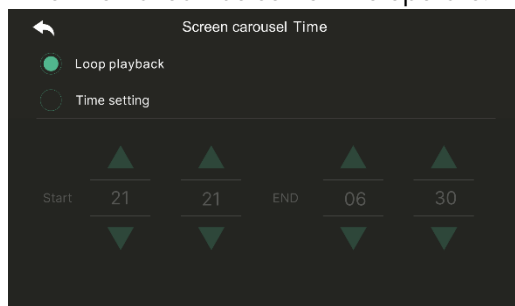

Night mode: choose to dimm the screen brightness in a given time interval.

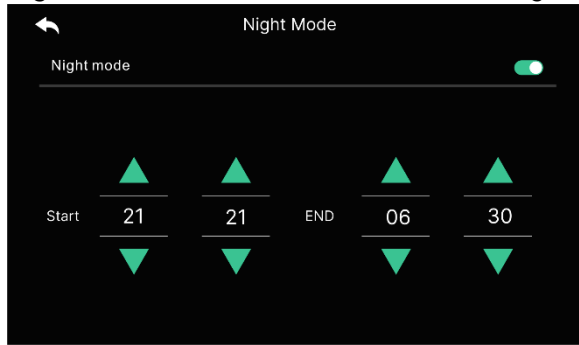

List of display: select the features you wish to display on the monitor screen together with the screen carousel function.

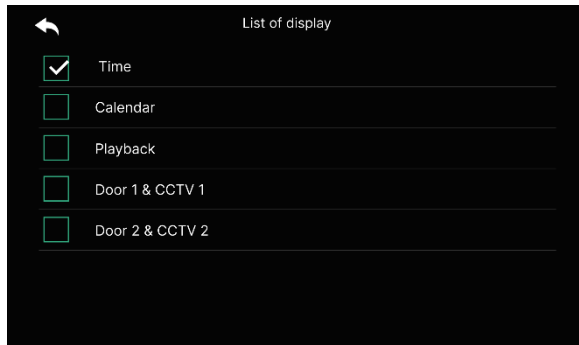

Screen carousel time: select the background you wish to display together with the screen carousel function.

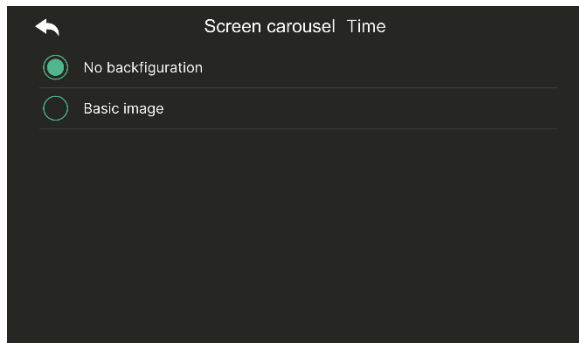

No backfiguration: the selected screen is displayed without background images.

Basic image: the background is set randomly from the images stored in the internal memory.

Display cleaning mode

When selecting this function, the touchscreen is inactive for 30 seconds.

Display

Set the brightness of the menu screen.

ETC

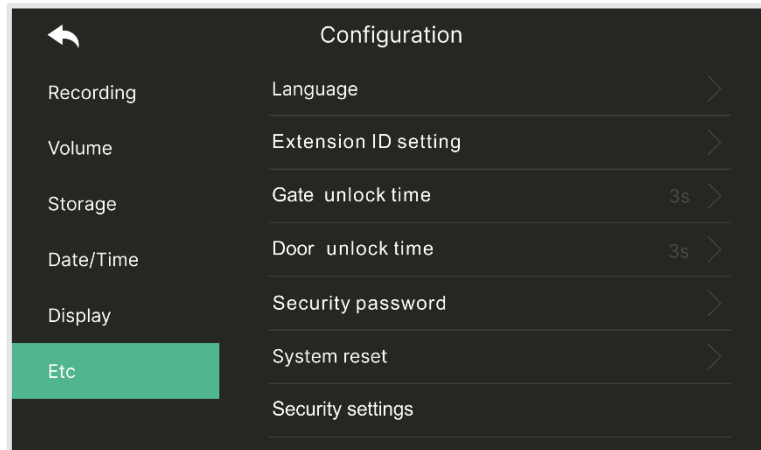

Language

Set the language of the menu, choose from: Polish, English, German, French, Portuguese, Arabic, Turkish, Korean, Russian, Spanish, Chinese.

Extension ID setting

If multiple monitors are connected, select a different ID number for each monitor.

Gate/Door unlock time

Configure the gate/door opening time.

Security password

Default setting: 1234. The password must be set in order to deactivate the security mode or cancel the alarm (password must consist of 4 digits, combinations not allowed: 0000, 1234, 4321).

Setting the password: Enter the Security password menu and enter the current 4-digit password using the numeric keypad displayed on the screen and then enter a new password twice. If the password is lost, restore the factory settings on the device (all settings will be cleared). When the factory settings are restored, the security password is set back to 1234.

System reset

Security settings

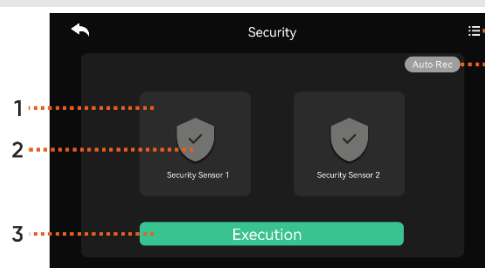

Before setting the alarm

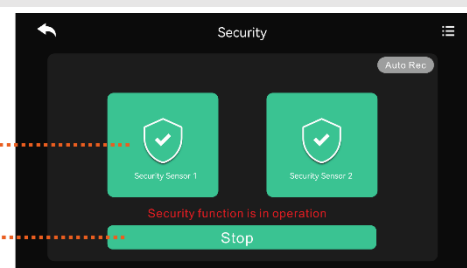

After setting the alarm

Before setting the alarm

1: Sensor selection: Security Sensor 1/Security Sensor 2

2: Activate/deactivate alarm detector

3: Confirm selection

4: Alarm log: displays a list of all alarm events

5: Auto-recording: the CCTV camera will automatically start recording for 10 seconds when a security alarm is triggered. When the function is activated, it is highlighted in red.

In case of a detector 1 alarm, recording is captured by CCTV camera 1, in case of a detector 2 alarm, recording is captured by CCTV camera 2.

If there is no SD memory card in the device, the system takes a picture instead.

After setting the alarm

6: Indicates which detectors have the security alarm function activated.

7: Deactivate the alarm function: press the Stop button and enter the 4-digit security password (factory setting 1234).

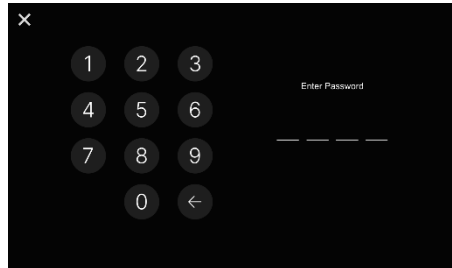

Entering the security password



Alarm activation

When an emergency alarm is triggered, the alarm siren goes off for **3 minutes**. An alarm activation message is displayed on the monitor screen. The sound is emitted by the monitor.

Version

Displays the current software version.

SD CARD

SD memory card information:

- SDHC / SDXC: 128 GB max (class 10 or higher),
- format, file system: FAT32,
- max. resolution of recorded photos/videos: 1920x1080px
- max. monitor capacity (without installed memory card): 30 images

1. Do not insert/remove the microSD card during playback, saving or formatting etc. This may cause malfunction and damage to the files.
2. When the capacity of the microSD card is full, the oldest films are automatically deleted and the newest films are saved in their place.

13. CLEANING AND MAINTENANCE

- The monitor should not be placed in a location exposed to high temperatures, in direct sunlight or high humidity locations (e.g. bathroom),
- the monitor should not be placed near a TV or other objects that may cause interference of the signal,
- do not touch the device with wet hands,
- clean the camera lens with a dry cloth. Do not use chemical cleaners,
- do not place the camera in direct sunlight,
- make sure there is no signal interference before mounting the device in the desired location,
- avoid switching off the device during recording, data may be lost.

14. TROUBLESHOOTING

1. No audio/video, no indicator light

- a) no supply voltage,
- b) damaged or incorrectly connected connecting cable, check your installation for technical requirements,
- c) check that the installation is not exposed to water, moisture etc.,
- d) check that the camera lens is not obstructed by an object that prevents proper view.

2. No video but audio is normal

- a) check that all connections are made correctly with regard to technical requirements,
- b) check that the camera lens is not obstructed by an object that prevents proper view.

3. No audio when calling

- a) ensure that the monitor volume is not set to the lowest setting,
- b) ensure that there are no objects in the vicinity of the device that could cause interfering with the signal,
- c) check that all connections are made correctly with regard to technical requirements.

4. Outdoor unit cannot call the monitor

- a) check that all connections are made correctly with regard to technical requirements.



5. Electric door strike not working

- a) check the independent operation of the electric door strike by connecting it to the required voltage, etc.,
- b) check that the parameters of the electric door strike are consistent with the operating manual.

6. Cannot hear the visitor when answering a call

- a) press the  button to activate two-way intercom,
- b) check that all connections are made correctly with regard to technical requirements.

7. You can hear the visitor when you receive a call, but you cannot answer them

- a) press the  button to activate two-way intercom (pressing the  button on the monitor, the outdoor unit cannot hear the indoor unit),
- b) check that all connections are made correctly with regard to technical requirements.